

# Catálogo

Perfis Extrudados de Alumínio



1ª Edição  
Janeiro/2024

DESCONSIDERAR EDIÇÕES ANTERIORES

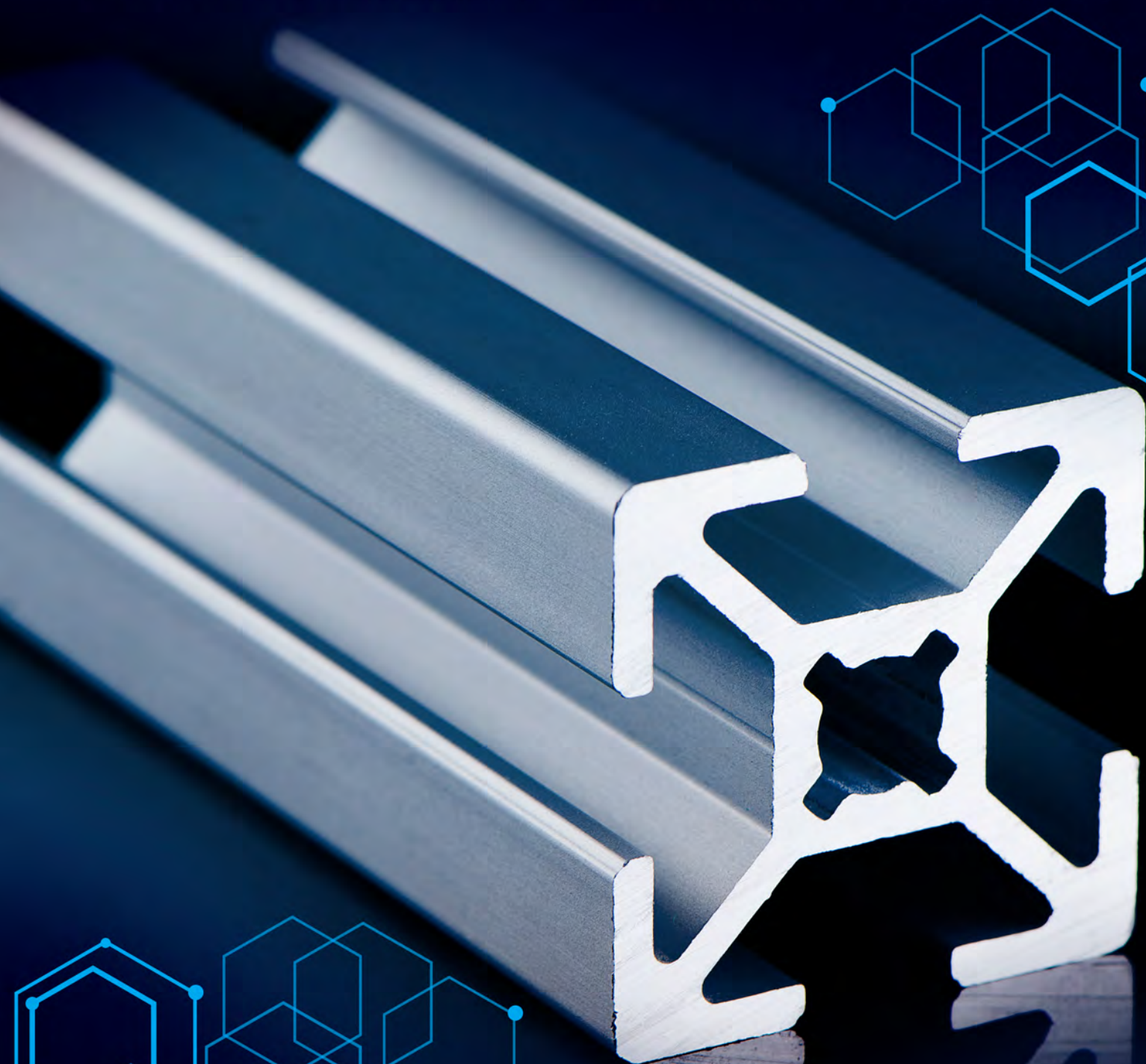

extrutech alumínio



[extrutech.com.br](http://extrutech.com.br)



extrutech alumínio

# SOBRE NÓS

Possuímos soluções que se encaixam nas mais diversas necessidades e perfis de negócios. Além disso, desenvolvemos projetos sob medida para nossos clientes.



Soluções que combinam eficiência e estética que você procura com a competitividade que você deseja. Atuamos no setor da construção civil e indústria. Completo estoque de perfis de alumínio e acessórios em geral, das principais linhas do mercado.



[www.extrutech.com.br](http://www.extrutech.com.br)



# UMA EMPRESA INOVADORA



Acompanhando sempre a evolução da tecnologia, nossos equipamentos são modernos e com recursos que otimizam todo o processo.

Fornecemos produtos de excelente qualidade, com custos competitivos e com suporte aos mais variados segmentos do mercado. Além da infraestrutura física, dispomos de um corpo técnico especializado para análises técnicas e desenvolvimentos de ferramentas e peças que exigem minuciosidade em cada detalhe dimensional, desde perfis pequenos até os projetos de maior escala.



extrutech alumínio

## Propriedades Físicas

Liga	Peso Específico (g/cm <sup>3</sup> )	Módulo de Elasticidade MPa	Módulo de Rigidez MPa	Temperatura de Fusão (°C)	Calor Específico (0-100°C) & DOJ (°C)	Coefficiente de Expansão Linear (L/°C)	Condutibilidade Térmica (25°) (Cal./cm <sup>2</sup> C)	Condutibilidade Elétrica (ACS)%
1050	2.70	70000	26500	650-660	0.22	24x10 <sup>-6</sup>	0.50	60.0
3003	2.73	70000	26500	640-655	0.22	23x10 <sup>-6</sup>	0.38	43.0
5052	2.68	72000	27500	595-650	0.23	23x10 <sup>-6</sup>	0.33	34.0
6005	2.71	70000	26500	580-650	0.22	24x10 <sup>-6</sup>	0.37	40.0
6060	2.71	70000	26500	600-650	0.21	23x10 <sup>-6</sup>	0.48	52.0
6061	2.71	70000	26500	580-650	0.22	24x10 <sup>-6</sup>	0.37	40.0
6063	2.71	70000	26500	600-650	0.21	23x10 <sup>-6</sup>	0.48	52.0
6082	2.71	70000	26500	555-650	0.21	24x10 <sup>-6</sup>	0.44	45.5
6101	2.71	70000	26500	605-655	0.22	23x10 <sup>-6</sup>	0.49	55.0
6261	2.71	70000	26000	570-655	0.22	23x10 <sup>-6</sup>	0.44	47.0
6262	2.71	70000	26700	582-652	0.21	23x10 <sup>-6</sup>	0.37	44.0
6351	2.71	70000	26500	555-650	0.21	24x10 <sup>-6</sup>	0.44	45.5
6463	2.71	70000	26500	600-650	0.21	23x10 <sup>-6</sup>	0.48	52.0
7075	2.80	73000	27500	475-630	0.23	24x10 <sup>-6</sup>	0.29	30.0

## Características Específicas

Liga	Resistência à corrosão	Anodização Decorativa	Anodização Protetora	Solda MIG	Solda TIG	Usinagem	Deform. à frio	Brasagem	Outras
1050	A	A	A	A	A	E	A	A	
3003	A	D	B	A	A	D	A	A	
5052	A	A	A	A	A	C	A	B	
6005	A	D	A	A	A	D	B	A	
6060	A	A	A	A	A	D	B	A	
6061	A	D	A	A	A	D	B	A	
6063	A	A	A	A	A	D	B	A	
6082	A	D	A	A	A	C	C	C	
6101	A	A	A	A	A	D	B	A	
6261	A	C	A	A	A	C	C	B	
6262	B	C	A	A	A	A	C	A	
6351	A	D	A	A	A	C	C	C	
6463	A	A	A	A	A	D	B	A	
7075	C	E	B	N	N	D	B	N	Solda por resistênci

## Composição Química(%peso)

Liga	Al	Si	Fe	Cu	Mn	Mg	Cr	Zn	Ti	Outros	
										CADA	TOTAL
1050	99.50	0.25	0.40	0.05	0.05	0.05	-	0.05	0.03	0.03	-
3003	-	-	-	0.05	1.0	-	-	-	-	-	-
	-	0.6	0.7	0.20	1.5	-	-	0.10	-	0.05	0.15
5052	-	-	-	-	-	2.2	0.15	-	-	-	-
	-	0.25	0.40	0.10	0.10	2.8	0.35	0.10	-	0.05	0.15
6005	-	0.6	-	-	-	0.4	-	-	-	-	-
	-	0.9	0.35	0.10	0.10	0.6	0.10	0.10	0.10	0.05	0.15
6005 A	-	0.5	-	-	-	0.4	-	-	-	-	-
	-	0.9	0.35	0.30	0.50	0.7	0.30	0.20	0.10	0.05	0.15
6060	-	0.30	0.10	-	-	0.35	-	-	-	-	-
	-	0.60	0.30	0.10	0.10	0.60	0.05	0.10	0.10	0.05	0.15
6061	-	0.40	-	0.15	-	0.8	0.04	-	-	-	-
	-	0.8	0.7	0.40	0.15	1.2	0.35	0.25	0.15	0.05	0.15
6063	-	0.20	-	-	-	0.45	-	-	-	-	-
	-	0.60	0.35	0.10	0.10	0.9	0.10	0.10	0.10	0.05	0.15
6082	-	0.7	-	-	0.4	0.6	-	-	-	-	-
	-	1.3	0.5	0.10	1.0	1.2	0.25	0.20	0.10	0.05	0.15
6261	-	0.40	-	0.15	1.0	0.6	-	-	-	-	-
	-	0.7	0.40	0.40	0.35	1.2	0.25	0.20	0.10	0.05	0.15
6262	-	0.40	-	0.15	-	0.8	0.04	-	-	-	-
	-	0.8	0.7	0.40	0.15	1.2	0.14	0.25	0.15	0.05	0.15
6351	-	0.7	-	-	0.40	0.40	-	-	-	-	-
	-	1.3	0.50	0.10	0.8	0.8	-	0.20	0.20	0.05	0.15
6463	-	0.30	-	0.05	-	0.35	-	-	0.01	-	-
	-	0.60	0.15	0.20	0.05	0.65	-	0.03	0.03	0.05	0.15
7075	-	-	-	1.2	-	2.1	0.18	5.1	-	-	-
	-	0.40	0.50	2.0	0.30	2.9	0.28	6.1	0.20	0.05	0.15

Apresenta em sua composição Pb = 0.20-0.60% e Bi = 0.20-0.60% Apresenta em sua composição Pb = 0.40-0.70% e Bi = 0.40-0.70% Boro 0,05% máximo





extrutech alumínio

## ESPECIFICAÇÕES TÉCNICAS

### Característica e Aplicação

1050	Baixa resistência mecânica, alta resistência à corrosão, boa conformabilidade, fácil de soldar, apropriada para anodização decorativa.	Indústria química, farmacêutica e alimentícia; utensílios domésticos. Refrigeração (trocadores de calor em geral).
3003	Média resistência mecânica, alta resistência à corrosão, boa conformabilidade, boa soldabilidade.	Tubos para trocadores de calor (radiadores automotivos). Antenas.
5052	Boa resistência mecânica, alta resistência à corrosão, boa conformabilidade.	Vergalhões para rebites, transporte e equipamentos.
6005 A	Boa resistência mecânica, alta resistência à corrosão, boa conformabilidade, e média usinabilidade.	Rodas e acessórios de bicicletas esportivas e motocicletas, náutica e transporte em geral.
6060	Média resistência mecânica, alta resistência à corrosão, boa conformabilidade.	Perfis para construção civil, caixilharia em geral, tubos de irrigação, móveis e iluminação.
6061	Boa resistência mecânica, boa resistência à corrosão, boa conformabilidade. Média usinabilidade.	Estruturas, construção naval, veículos e rebites. Indústria moveleira.
6063	Apropriada para anodização decorativa fosca.	Móveis e Iluminação.
6101	Alta condutividade elétrica, média resistência mecânica, boa resistência à corrosão.	Liga especial para fins elétricos e barramentos (estruturas).
6261	Boa resistência mecânica, boa resistência à corrosão, boa conformabilidade. Média usinabilidade.	Carrocerias de veículos, estruturas e equipamentos.
6262	Ótima usinabilidade, alta resistência mecânica, alta resistência à corrosão, apropriada para anodização decorativa.	Peças usinadas em torno automático. Excelente alternativa para o latão de corte livre.
6351	Boa resistência mecânica, alta resistência à corrosão, boa conformabilidade, média usinabilidade.	Engenharia estrutural, construção de navios, veículos e equipamentos. Peças usinadas em tornos não automáticos. Forjamento a frio.
6463	Média resistência mecânica, boa resistência à corrosão, boa conformabilidade apropriada para anodização decorativa de alto brilho.	Painéis e frisos para eletrodomésticos, automóveis e armários.
7075	Os mais altos valores de resistência mecânica, média resistência à corrosão, boa forjabilidade e usinabilidade.	Peças sujeitas aos mais altos esforços mecânicos em indústria aeronáutica, militar, máquinas e equipamentos. Moldes para injeção de plástico.

### Propriedade Mecânica

Liga	Têmpera	Limite de Resistência à Tração MPa	Limite Convencional de escoamento MPa	Limite de Resistência ao Cisalhamento (MPa)	% de Alongamento em 50mm	Dureza Brinell 2,5/62,5
1050	O	95 (80)	- (30)	(62)	25	-
	H14	85 (100)	70 (80)	(72)	-	-
	H18	110 (130)	90 (100)	(76)	-	-
3003	O	130 (120)	- -	(76)	25	-
	H12	115 (140)	- -	-	-	-
	H14	140 (151)	- -	(97)	-	-
	H16	165 -	- -	(103)	-	-
	H18	185 -	- -	(110)	-	-
5052	O	220 (209)	- -	(123)	25	-
	H32	215 (227)	160 (183)	-	-	-
	H34	233 (260)	180 (235)	(144)	-	-
	H36	255 -	200 (250)	(165)	-	-
	H38	270 -	- -	(165)	-	-
6005 A	T6F	260 (270)	215 (230)	-	10	82
6060	O	130 (125)	- -	(76)	18	-
6061	O	150 -	110 -	(82)	16	-
	T4	180 (211)	110 (129)	(165)	16	-
	T6	260 (309)	240 (280)	(206)	8	(102)
	T6*	290 (351)	240 (332)	-	10	(105)
	T8	- (368)	- (348)	(100)	-	-
	T89	370 -	325 -	-	-	-
6063	T4A	110 (145)	60 (79)	(98)	-	-
6101	O	- (137)	- (82)	-	-	-
	T6	200 (230)	172 (213)	-	-	-
6261	T4A	157 (186)	83 (108)	-	-	-
	T4	181 (199)	98 (123)	-	-	-
	T6C	229 (280)	199 (248)	-	10	(90)
	T6	260 (309)	240 (280)	-	8	(102)
6262	T6	260 -	- -	-	10	-
	T9	360 (390)	330 (370)	-	5	(111)
6351	T4	220 (227)	130 (121)	(152)	16	(64)
	T6	290 (315)	255 (288)	(201)	8	(106)
6463	T5	150 (219)	110 (189)	(118)	8	66
	T6C	180 (226)	150 (197)	(135)	-	-
	T^	205 (235)	170 (213)	-	8	-
7075	O	275 -	165 -	-	-	-
	T6	560 (630)	495 (608)	(329)	-	(150)



extrutech alumínio

## ESPECIFICAÇÕES TÉCNICAS

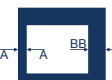

### Espessura de Parede

#### Tubos Quadrados, Sextavados, Retangulares e Sextavados

Espessura nominal da parede(mm)	 Desvio permitido da espessura média $AA+BB/2$ em relação a espessura nominal		 Desvio permitido da espessura em qualquer ponto em relação à espessura média (excentricidade) (+/- mm)	
	DCC (Diâmetro do Círculo Circunscrito em mm)			
	Menor que 127	Maior que 127	Menor que 127	Maior que 127
Até 1,19	0,13	0,20	0,13	10% da espessura média da parede  máx:1,52 mín:0,25
1,20 a 1,55	0,15	0,23	0,18	
1,56 a 1,95	0,18	0,25	0,25	
1,96 a 3,15	0,18	0,25	0,25	
3,16 a 6,34	0,20	0,38	0,36	
6,35 a 9,51	0,28	0,51	0,63	
9,52 a 12,69	0,36	0,76	0,76	
12,7 a 19,04	0,63	1,02	1,02	

### Espessura de Parede

#### Tubos Redondos

Espessura nominal da parede(mm)	 Desvio permitido da espessura média $AA+BB/2$ em relação à espessura nominal (+/- mm)				 Desvio permitido da espessura em qualquer ponto em relação a espessura média (+ mm)
	DCC (Diâmetro do Círculo Circunscrito em mm)				
	Até 31,75	Até 31,76 a 76,19	76,20 a 126,99	acima de 127	
Até 1,19	0,15	-	-	-	10% da espessura média  Máx:1,52 Mín:0,25
1,20 a 1,55	0,18	0,200	0,20	0,25	
1,56 a 1,95	0,20	0,200	0,23	0,30	
1,96 a 3,15	0,23	0,230	0,25	0,38	
3,16 a 6,34	0,23	0,230	0,33	0,51	
6,35 a 9,51	0,28	0,280	0,41	0,63	
9,52 a 12,69	-	0,380	0,53	0,89	
12,7 a 19,04	-	0,510	0,71	1,14	

### Altura e Largura

#### Tubos Quadrados, Sextavados, Retangulares e Sextavados

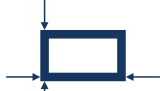
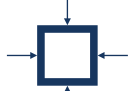
Espessura nominal da parede(mm)	Nos Cantos	Em lados Opostos(1)	
	 Tubos Quadrados e Retangulares	 Tubos Quadrados Sextavados e Oitavados	Tubos Retangulares
Desvio permitido da altura (ou) largura em relação à dimensão nominal (+/- mm)			
Tubos Extrudados			
12,70 a 19,05	0,30	0,51	A tolerância para a largura é o valor da tolerância para uma dimensão igual à altura, e inversamente, mas em nenhum caso esta tolerância é menor for menor do que nos cantos (2)
19,06 a 25,40	0,36	0,51	
25,41 a 50,80	0,46	0,63	
50,81 a 101,60	0,63	0,89	
101,61 a 126,70	0,89	1,14	
126,71 a 152,40	1,14	1,40	

(1) Não aplicável em tempera 0, tubos em rolos ou tubos cuja espessura de parede for inferior a 0,5mm ou 2,5% do diâmetro externo da circunferência equivalente (diâmetro do círculo cuja circunferência mede o perímetro do tubo).

(2) E x.: em um tubo retangular extrudado de 76,20 x 38,10 mm, a tolerância na largura (76,20) é de +/- 0,63 mm e na altura (38,10), é de +/- 0,89 mm.





extrutech alumínio

## ESPECIFICAÇÕES TÉCNICAS

### Tolerâncias na seção transversal

Em dimensões de metal			Dimensões entre superfície metálica														
Dimensão especificado incluindo mais de 75% de metal			Dimensões especificadas incluindo mais de 25% de vazio <sup>(4)(5)</sup>														
Dimensão nominal (mm)	Todas as Dimensões exceto as especificadas na coluna 3	Espessura de parede de vazios fechados de mais de 70mm (excentricidade)(3)	Distância entre a dimensão especificada e a base mais próxima(mm)														
			5a15	15a30	30a60	60a100	100a150	150a200									
			Coluna1	Coluna2	Coluna3	Coluna4	Coluna5	Coluna6	Coluna7	Coluna8	Coluna9						
Até - 3,2	0,15	Mais ou menos	0,25	0,30	-	-	-	-	-	-	-	-	-	-	-	-	-
3,2-6,3	0,18	10% da	0,36	0,36	0,41	-	-	-	-	-	-	-	-	-	-	-	-
6,3-12,5	0,20	espessura	0,41	0,41	0,46	0,50	0,56	-	-	-	-	-	-	-	-	-	-
12,5-20	0,23	nominal	0,46	0,46	0,50	0,56	-	-	-	-	-	-	-	-	-	-	-
20-25	0,25		0,50	0,50	0,56	0,64	0,76	-	-	-	-	-	-	-	-	-	-
25-40	0,30	(0,25mm	0,58	0,58	0,66	0,76	0,88	-	-	-	-	-	-	-	-	-	-
40-50	0,36	mínimo)	0,66	0,66	0,78	0,92	1,05	1,25	-	-	-	-	-	-	-	-	-
50-100	0,60		0,96	0,96	1,20	1,45	1,70	2,05	-	-	-	-	-	-	-	-	-
100-150	0,86	(1,50mm	1,25	1,25	1,65	2,00	2,40	2,80	-	-	-	-	-	-	-	-	-
150-200	1,10	Máximo)	1,55	1,55	2,40	2,50	3,05	3,55	-	-	-	-	-	-	-	-	-
200-250	1,35		1,90	1,90	2,50	3,05	3,70	4,30	-	-	-	-	-	-	-	-	-

### Retilinearidade

Diâmetro do menor círculo circunscrito (mm) (1)	Espessura mínima (mm)	Desvio(D) permissível por metro de comprimento (mm) (2)
Até 38,09	até 2,4	4,0
Até 38,10	Acima de 2,4	1,0
Acima de 38,10	Qualquer	1,0

### Torção



Diâmetro do menor círculo circunscrito (mm) (1)	Desvio(Y) permissível (graus)		
	Por metro de comprimento	No comprimento total	Torção Máxima
Até 38,09	3,3	3,3xL(metros)	7%
De 38,09 a 76,19	1,6	1,6xL(metros)	5%
Acima de 76,20	0,8	0,8xL(metros)	3%



extrutech alumínio

## ESPECIFICAÇÕES TÉCNICAS

### Diâmetros de Tubos Redondos

Diâmetro nominal da (mm)	 Desvio permissível do diâmetro médio $AA+BB/2$ em relação a espessura nominal	 Desvio permissível do diâmetro em qualquer ponto em relação ao diâmetro nominal (+_mm)(1)
	6,35 a 25,39 25,40 a 50,79 50,80 a 101,59 101,60 a 152,39 152,40 a 203,19 203,20 a 253,99	0,25 0,30 0,38 0,64 0,89 1,14

### Comprimento

Diâmetro Externo ou largura nominal (mm) (1)	Desvio permissível em relação ao comprimento nominal (somente a mais) (mm)		
	Comprimento Nominal(mm)		
	Até 3.660	3.661 a 9.150	9.151 a 15.25
Até 76,193 De 76,20 a 203,204 Acima de 203,206	3,2 4,8 6,4	6,4 7,9 9,5	9,5 11,1 12,7

### Angularidade

Espessura mínima da aba (mm) (3)	Desvio permissível em relação ao ângulo nominal (graus) (4)
Até 4,75 de 4,76 a 19,04 acima de 19,05	+_-2,0 +_-1,5 +_-1,0

Desvio permissível do quadro +/- 1°.

(1) Para vergalhões diâmetro nominal, para barras largura nominal.

(2) Para se obter o desvio permissível em barras de mais de 1 metro de comprimento, multiplica-se o valor d o comprimento pelo valor do desvio por metro.

(3) Quando houver duas abas adjacentes, considera-se a de menor espessura.

(4) Quando o espaço limitado pelo ângulo é todo metal, considera-se a menor espessura de metal no vértice do ângulo.





extrutech alumínio

## Índice de perfis

Standart.....	10
Box de Vidro 8mm.....	20
Boxde Vidro 10mm.....	22
Vidro Temperado.....	23
Vidro Temperado 8mm.....	24
Vidro Temperado 10mm.....	28
Porta Deslizante.....	31
Kit Pia.....	32
Contra Marco/Arremates.....	33
Padronizados - Porta de Giro.....	36
Padronizados - Janela de Correr.....	39
Padronizados - Venezianas.....	40
Venezianas.....	42
Linha 25.....	46
Linha 28.....	54
Linha 30.....	56
Linha Supremme.....	59
Linha Integrada.....	82
Linha Gold.....	91
Fachada.....	106
Lambris.....	115
Portões.....	123
Gradil.....	129
Guarda Corpo.....	130
Corrimão.....	134
Telas.....	135
Persianas.....	136
Agrícola.....	144
Policarbonato e Cobertura.....	147
Móveis, Piscina e Jardins.....	149
Escadas.....	153
Componentes para Esquadrias.....	155
Automação Industrial.....	158
Implementos Rodoviários.....	160
Perfis Diversos.....	173

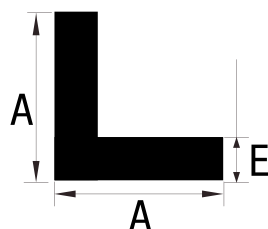

## Cantoneiras de Abas Iguais

CÓDIGO	POLEGADAS		MILÍMETROS		PESO
	A	E	A	E	
ECT-003	1/2	-	12,70	1,00	0,066
ECT-007	1/2	1/16	12,70	1,58	0,102
ECT-008	5/8	1/16	15,88	1,58	0,129
ECT-004	3/4	-	19,05	1,00	0,100
ECT-005	3/4	-	19,05	1,58	0,156
ECT-006	3/4	1/16	19,05	3,18	0,300
ECT-010	7/8	1/8	22,22	3,18	0,354
ECT-011	5/8	1/8	15,88	1,00	0,083
ECT-012	1	-	25,40	1,00	0,134
ECT-013	1	-	25,40	1,20	0,161
ECT-002	1	1/16	25,40	1,58	0,210
ECT-018	1	1/8	25,40	3,18	0,409
ECT-016	1 1/4	1/16	31,75	1,58	0,264
ECT-019	1 1/4	1/8	31,75	3,18	0,518
ECT-001	1 1/2	1/16	38,10	1,58	0,318
ECT-023	1 1/2	1/8	38,10	3,18	0,627
ECT-024	1 1/2	3/16	38,10	4,76	0,918
ECT-025	2	1/16	50,80	1,58	0,427
ECT-028	2	-	50,80	2,00	0,538
ECT-026	2	1/8	50,80	3,18	0,845
ECT-027	2	3/16	50,80	4,76	1,245
ECT-030	2	3/8	50,80	9,52	2,367



## Cantoneiras de Abas Desiguais

CÓDIGO	POLEGADAS			MILÍMETROS			PESO
	A	B	E	A	B	E	
ECT-200	-	-	-	22,50	12,50	2,20	0,195
ECT-201	2	1	1/8	50,80	25,40	3,18	0,627



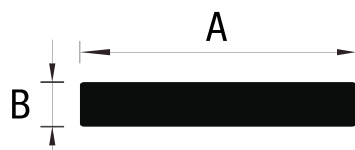

## Barra Chata

CÓDIGO	POLEGADAS		MILÍMETROS		PESO
	A	B	A	B	
EBC-001	3/8	1/8	9,52	3,18	0,082
EBC-002	1/2	1/8	12,70	3,18	0,109
EBC-003	5/8	1/8	15,88	3,18	0,136
EBC-005	5/8	3/16	15,88	4,76	0,204
EBC-006	3/4	1/8	19,05	3,18	0,164
EBC-011	3/4	1/4	19,05	6,35	0,327
EBC-007	3/4	3/8	19,05	9,52	0,490
EBC-009	7/8	1/8	22,22	3,18	0,191
EBC-010	1	1/16	25,40	1,58	0,108
EBC-013	1	1/8	25,40	3,18	0,218
EBC-014	1	1/4	25,40	6,35	0,435
EBC-016	1	3/8	25,40	9,52	0,653
EBC-043	1	1/2	25,40	12,70	0,871
EBC-017	1 1/4	1/8	31,75	3,18	0,273
EBC-030	1 1/4	3/16	31,75	4,76	0,408
EBC-019	1 1/4	1/4	31,75	6,35	0,544
EBC-040	1 1/4	3/8	31,75	9,52	0,816
EBC-020	1 1/2	1/8	38,10	3,18	0,327
EBC-021	1 1/2	3/16	38,10	4,76	0,490
EBC-022	1 1/2	1/4	38,10	6,35	0,653
EBC-042	1 1/2	1/4	38,10	6,35	0,653
EBC-029	1 1/2	3/4	38,10	19,05	1,960
EBC-023	1 1/2	1	38,10	25,40	2,613
EBC-038	-	-	42,00	4,50	0,510
EBC-024	2	1/8	50,80	3,18	0,436
EBC-025	2	3/16	50,80	4,76	0,653
EBC-026	2	1/4	50,80	6,35	0,871
EBC-027	2	3/8	50,80	9,52	1,306
EBC-028	2 1/2	1/8	63,50	3,18	0,545
EBC-032	3	1/8	76,20	3,18	0,654
EBC-037	3	1/2	76,20	12,70	2,613
EBC-031	3	3/4	76,20	19,05	3,919
EBC-035	-	-	82,00	1,30	0,288
EBC-036	4	1/8	101,60	3,18	0,872
EBC-300	6	5/16	152,40	7,93	3,263
EBC-034	6	1/2	152,40	12,70	5,226
EBC-302	8	1/2	203,20	12,70	6,968

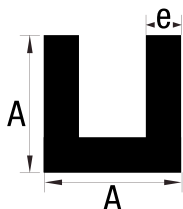

## Perfil U de Abas Iguais

CÓDIGO	POLEGADAS		MILÍMETROS		PESO
	A	E	A	E	
EPU-003	-	3/76	12,50	1,00	0,096
EPU-004	1/2	1/16	12,70	1,58	0,149
EPU-002	5/8	3/76	15,88	1,00	0,123
EPU-104	3/4	1/16	19,05	1,58	0,230
EPU-106	1	1/16	25,40	1,58	0,312

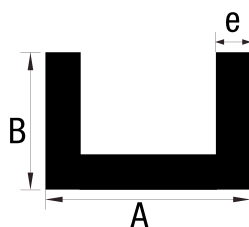

## Perfil U de Abas Desiguais

CÓDIGO	POLEGADAS			MILÍMETROS			PESO
	A	B	E	A	B	E	
EPU-556	-	--		11,00	22,00	1,00	0,143
EPU-553	-	-	-	11,60	22,00	1,00	0,145
EPU-010	5/8	3/8	3/32	15,88	9,52	2,38	0,194
EPU-550	1	-	-	25,40	20,00	1,10	0,188
EPU-639	-	-	-	29,00	35	1,20	0,313
EPU-075	-	-	-	31,50	13,5	2,00	0,294
EPU-006	2	4	1/8	50,80	101,6	3,18	2,126



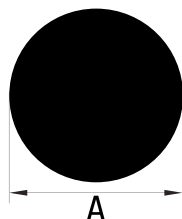

## Vergalhão Redondo

CÓDIGO	POLEGADAS	MILÍMETROS	PESO
EVR-002	3/16	4,76	0,048
EVR-020	-	5,40	0,062
EVR-004	1/4	6,35	0,086
EVR-005	5/16	7,94	0,134
EVR-007	-	9,00	0,172
EVR-008	3/8	9,52	0,192
EVR-009	-	12,00	0,305
EVR-010	1/2	12,70	0,342
EVR-027	9/16	14,28	0,432
EVR-012	5/8	15,88	0,535
EVR-014	3/4	19,05	0,770
EVR-080	3/4	19,05	0,770
EVR-015	7/8	22,22	1,047
EVR-016	1	25,40	1,368
EVR-083	1	25,40	1,368
EVR-017	1 1/8	28,58	1,732
EVR-018	1 1/4	31,75	2,138
EVR-028	1 3/8	34,90	2,583
EVR-029	1 1/2	38,10	3,078
EVR-030	-	38,50	3,143
EVR-021	1 3/4	44,45	4,190
EVR-085	2	50,80	5,472
EVR-026	2 1/4	57,15	6,926
EVR-023	2 1/2	63,50	8,551
EVR-025	3	76,20	12,313

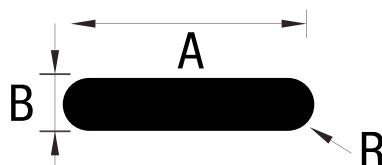

## Barramentos Elétricos

CÓDIGO	POLEGADAS			MILÍMETROS			PESO
	A	B	R	A	B	R	
EBE-100	5/8	1/8	1/16	15,88	3,18	1,59	0,130
EBE-001	-	-	-	16,00	4,00	2,00	0,164
EBE-002	-	-	-	25,00	6,00	3,00	0,384
EBE-021	-	-	-	32,00	6,00	3,00	0,498
EBE-004	-	-	-	50,00	6,00	3,00	0,789
EBE-006	-	-	-	65,00	6,00	3,00	1,032
EBE-008	-	-	-	80,00	6,00	3,00	1,275
EBE-009	-	-	-	100,00	6,00	3,00	1,599
EBE-020	-	-	-	110,00	6,00	3,00	1,761
EBE-013	-	-	-	160,00	6,00	3,00	2,571
EBE-015	-	-	-	180,00	3,00	3,00	1,510
EBE-016	-	-	-	200,00	6,00	3,00	3,219
EBE-017	-	-	-	210,00	6,00	3,00	3,381
EBE-018	-	-	-	152,00	6,35	3,17	2,582
EBE-019	-	-	-	175,00	6,45	3,22	3,023

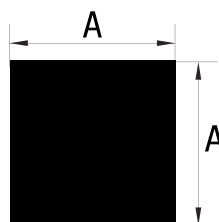

## Vergalhão Quadrado

CÓDIGO	POLEGADAS	MILÍMETROS	PESO
EVQ-006	-	12,00	0,389
EVQ-012	1	25,40	1,742

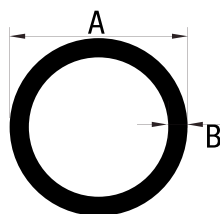

## Tubos Redondos

CÓDIGO	POLEGADAS		MILÍMETROS		PESO
	A	E	A	E	
ETR-001	1/2	-	12,70	1,00	0,099
ETR-002	1/2	1/16	12,70	1,58	0,149
ETR-400	-	-	13,20	1,40	0,140
ETR-101	5/8	-	15,88	0,90	0,114
ETR-015	5/8	-	15,88	1,00	0,126
ETR-003	5/8	-	15,88	1,20	0,149
ETR-004	5/8	1/16	15,88	1,58	0,192
ETR-102	3/4	-	19,05	0,90	0,139
ETR-080	3/4	-	19,05	7,03	0,717
ETR-005	3/4	-	19,05	1,20	0,182
ETR-006	3/4	1/16	19,05	1,58	0,234
ETR-600	3/4	1/4	19,05	6,35	0,684
ETR-013	-	-	20,00	4,90	0,628
ETR-007	7/8	-	22,22	0,80	0,145
ETR-008	7/8	1/16	22,22	1,58	0,277
ETR-009	7/8	1/8	22,22	3,18	0,514
ETR-010	1	-	25,40	0,80	0,167
ETR-011	1	-	25,40	1,00	0,207
ETR-012	1	1/16	25,40	1,58	0,319
ETR-014	1	1/8	25,40	3,18	0,599
ETR-083	1	-	25,40	8,35	1,208
ETR-016	1 1/4	-	31,75	1,00	0,261
ETR-017	1 1/4	1/16	31,75	1,58	0,404
ETR-018	1 1/4	-	31,75	2,00	0,505
ETR-019	1 1/4	1/8	31,75	3,18	0,771
ETR-084	1 3/8	5/16	34,90	7,95	1,817
ETR-100	1 1/2	-	38,10	1,00	0,315
ETR-020	1 1/2	1/16	38,10	1,58	0,489
ETR-041	1 1/2	-	38,10	2,30	0,698
ETR-073	1 1/2	1/8	38,10	3,18	0,942
ETR-024	2	-	50,80	1,20	0,505
ETR-025	2	-	50,80	1,50	0,627
ETR-040	2	-	50,80	3,00	1,216
ETR-027	2	1/8	50,80	3,18	1,284
ETR-028	2	1/4	50,80	6,35	2,394
ETR-029	2	-	50,80	15,40	4,624
ETR-085	2	-	50,80	22,15	5,383
ETR-038	2 1/2	1/8	63,50	3,18	1,630
ETR-032	3	-	76,20	1,40	0,888
ETR-033	3	1/8	76,20	3,18	1,970
ETR-039	-	-	88,90	1,20	0,893
ETR-035	4	-	101,60	1,27	1,081
ETR-036	4	1/8	101,60	3,18	2,655
ETR-050	6	1/8	152,40	3,18	4,025



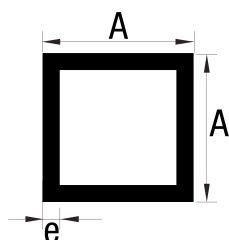

## Tubo Quadrado

CÓDIGO	POLEGADAS		MILÍMETROS		PESO
	A	E	A	E	
ETQ-400	1/2	-	12,70	0,90	0,114
ETQ-001	1/2	1/16	12,70	1,58	0,200
ETQ-025	-	-	13,50	0,80	0,108
ETQ-002	-	-	14,00	0,80	0,112
ETQ-003	5/8	-	15,88	0,80	0,129
ETQ-004	5/8	1/16	15,88	1,58	0,254
ETQ-006	3/4	-	19,05	1,00	0,195
ETQ-007	3/4	1/16	19,05	1,58	0,308
ETQ-019	-	-	22,00	0,80	0,181
ETQ-005	-	-	24,00	0,80	0,199
ETQ-100	1	-	25,40	0,90	0,237
ETQ-011	1	-	25,40	1,00	0,264
ETQ-013	1	-	25,40	1,00	0,264
ETQ-010	1	1/16	25,40	1,58	0,416
ETQ-011	1	-	25,40	1,00	0,264
ETQ-013	1	-	25,40	1,20	0,316
ETQ-020	-	-	27,00	0,80	0,225
ETQ-012	1 1/2	1/16	38,10	1,58	0,633
ETQ-060	2	-	50,80	1,00	0,538
ETQ-015	2	-	50,80	1,10	0,592
ETQ-016	2	-	50,80	1,20	0,645
ETQ-021	2	-	50,80	1,50	0,807
ETQ-017	2	1/16	50,80	1,58	0,850
ETQ-018	2	-	50,80	2,00	1,076
ETQ-037	3	-	76,20	1,20	0,975
ETQ-036	3	1/16	76,20	1,58	1,283

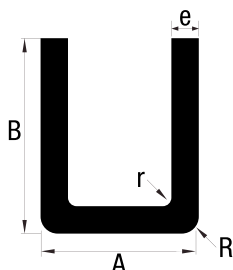

## Perfil U de Abas Desiguais com Raio

CÓDIGO	POLEGADAS				MILÍMETROS				PESO
	A	B	E	R	A	B	E	R	
EPU-122	-	1	-	-	9,00	25,4	1,5	1	0,230
EPU-202	-	-	-	-	14,00	25	2	2	0,324

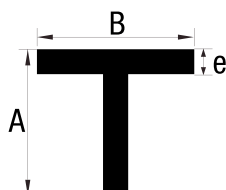

## Perfis T

CÓDIGO	POLEGADAS			MILÍMETROS			PESO
	A	B	E	A	B	E	
ET-122	1 1/4	1 1/4	1/16	31,75	31,75	1,58	0,264
ET-002	1 1/2	1 1/2	1/8	38,10	38,10	3,18	0,627
ET-051	-	-	-	60,00	80,00	1,20	0,450
ET-052	4	2	1/4	101,60	50,8	6,35	2,504

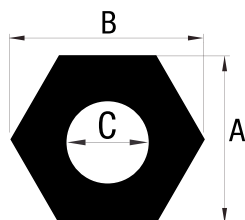

## Tubo Sextavado

CÓDIGO	POLEGADAS			MILÍMETROS			PESO
	A	B	C	A	B	C	
EVS-027	-	-	-	26,98	31,06	14	1,291
EVS-026	-	-	-	31,75	36,47	19	1,597
EVS-028	-	-	-	34,92	40,10	19	2,093
EVS-022	-	-	-	35,00	40,33	15	2,395

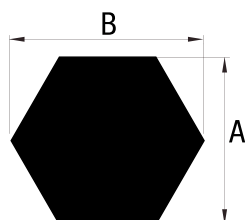

## Vergalhão Sextavado

CÓDIGO	POLEGADAS		MILÍMETROS		PESO
	A	B	A	B	
EVS-023	--		6,35	7,25	0,378
EVS-010	-	-	12,80	11,10	0,289
EVS-011	-	1	29,30	25,40	1,514
EVS-012	-	1.1/8	33,00	28,58	1,916
EVS-021	-	-	34,92	39,60	2,850
EVS-013	-	1.1/4	36,00	31,75	2,365



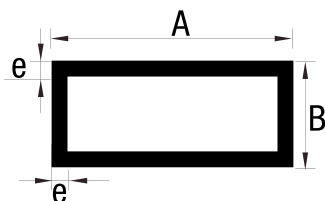

## Tubo Retangular

CÓDIGO	POLEGADAS			MILÍMETROS			PESO
	A	B	E	A	B	E	
ETG-500	1	1/2	-	25,40	12,70	1,15	0,222
ETG-505	1	1/2	-	25,40	12,70	0,80	0,158
ETG-003	-	-	-	30,80	18,50	1,20	0,304
ETG-006	1 1/2	1	-	38,10	25,40	1,20	0,396
ETG-007	1 1/2	1	1/16	38,10	25,40	1,58	0,515
ETG-010	2	1/2	1/16	50,80	12,70	1,58	0,515
ETG-011	2	1	-	50,80	25,40	0,90	0,362
ETG-012	2	1	-	50,80	25,40	1,00	0,401
ETG-013	2	1	-	50,80	25,40	1,20	0,478
ETG-014	2	1	-	50,80	25,40	2,00	0,780
ETG-008	2	1 1/2	-	50,80	38,10	2,00	0,917
ETG-260	2 3/8	1 1/2	-	60,30	38,10	1,20	0,622
ETG-019	-	1 1/2	1/8	72,20	38,10	3,18	1,785
ETG-027	3	1 1/2	-	76,20	38,10	1,20	0,725
ETG-028	3	1 1/2	-	76,20	38,10	1,80	1,076
ETG-020	-	-	-	80,00	42,00	5,00	3,024
ETG-026	4	2	-	101,60	50,80	1,20	0,975
ETG-024	4	2	-	101,60	50,80	1,40	1,131
ETG-023	4	2	1/16	101,60	50,80	1,58	1,273
ETG-022	4	2	-	101,60	50,80	1,80	1,446
ETG-025	4	2	1/8	101,60	50,80	3,18	2,508
ETG-029	6	2	1/8	152,40	50,80	3,18	3,380

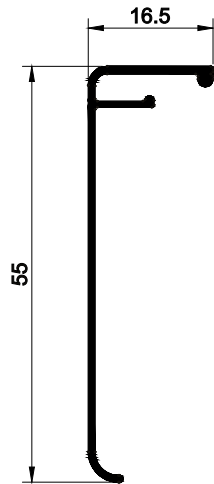

**EBX-108**  
0,206 kg/m

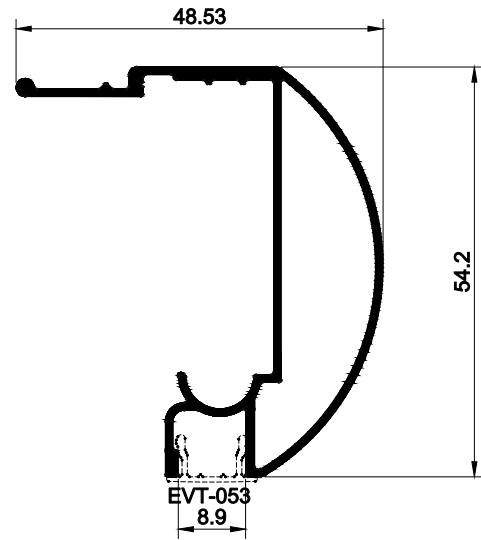

**EBX-107**  
0,545 kg/m

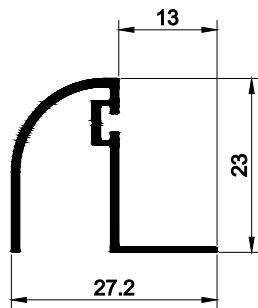

**EVT-011**  
0,198 kg/m

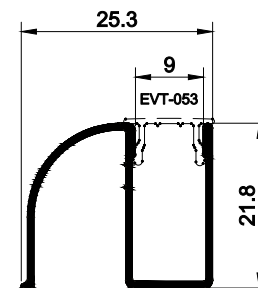

**EBX-109**  
0,210 kg/m

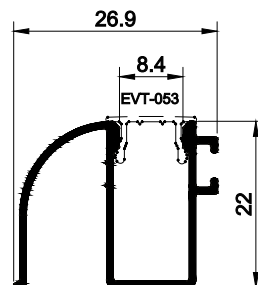

**EVT-109**  
0,234 kg/m

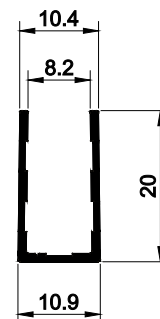

**EPU-550**  
0,129 kg/m

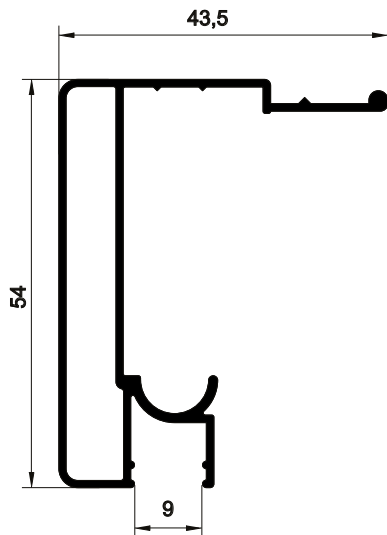

**EBX-045**  
0,523 kg/m

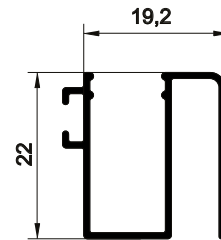

**EBX-046**  
0,200 kg/m

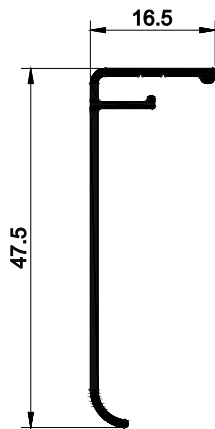

**EVT-051**  
0,206 kg/m

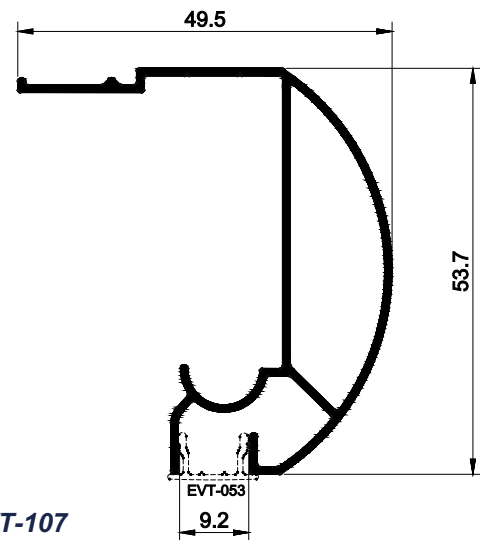

**EVT-107**  
0,509 kg/m

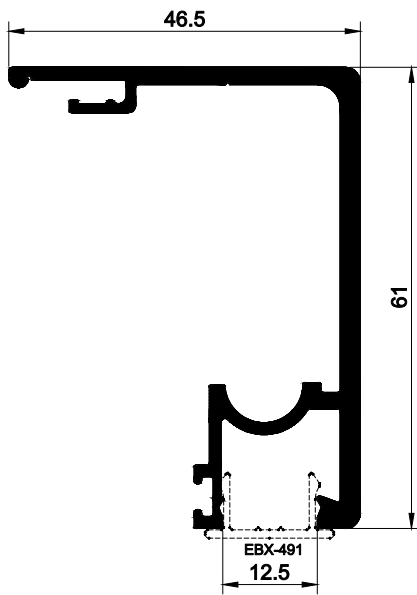

**EBX-035**  
0,967 kg/m

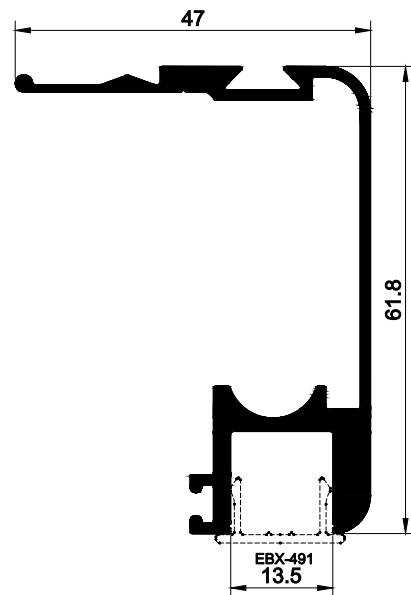

**EVT-007**  
0,895 kg/m

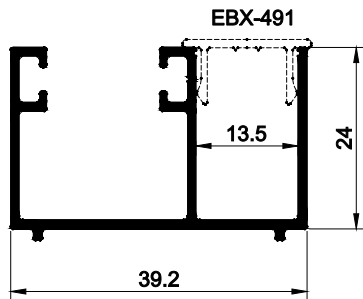

**EBX-029**  
0,406 kg/m

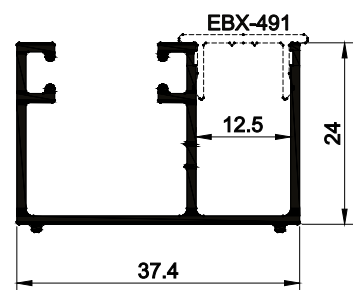

**EBX-037**  
0,405 kg/m



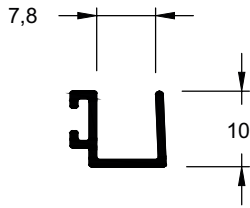

**EVT-012**  
0,096 kg/m

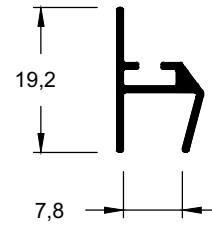

**EVT-013**  
0,116 kg/m

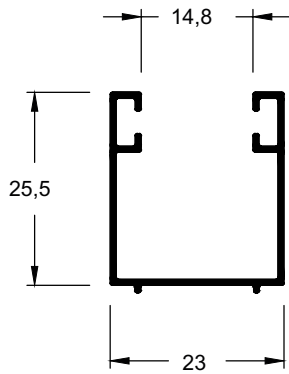

**EVT-014**  
0,204 kg/m

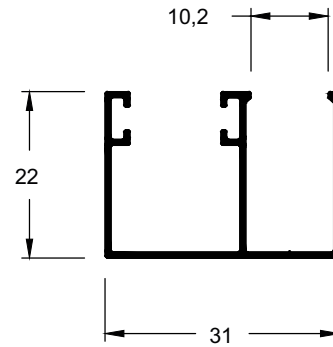

**EVT-015**  
0,241 kg/m

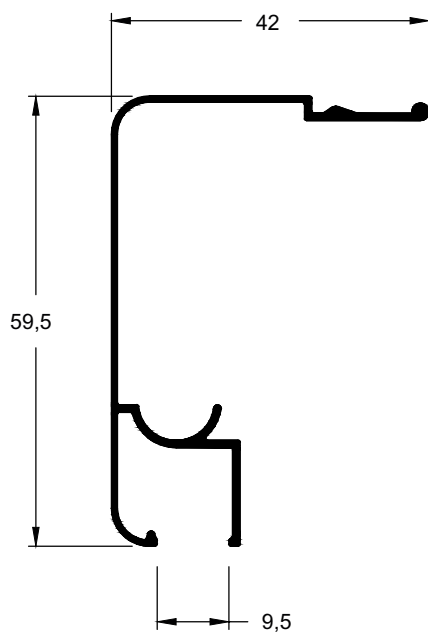

**EVT-016**  
0,354 kg/m

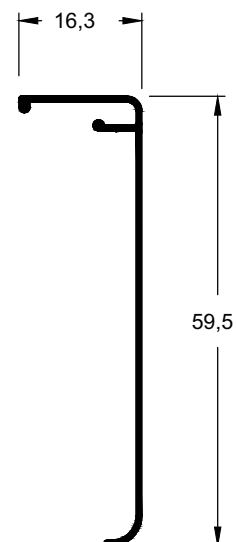

**EVT-017**  
0,186 kg/m

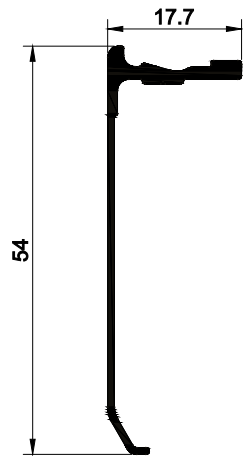

**EBX-022**  
0,243 kg/m

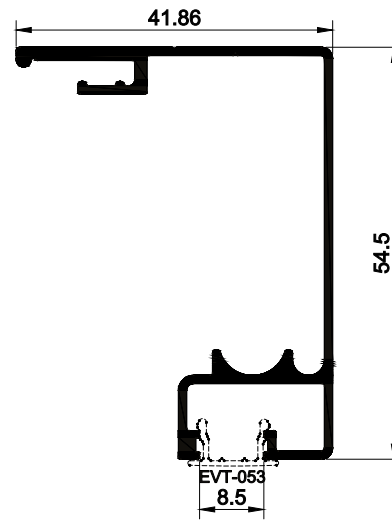

**EBX-024**  
0,537 kg/m

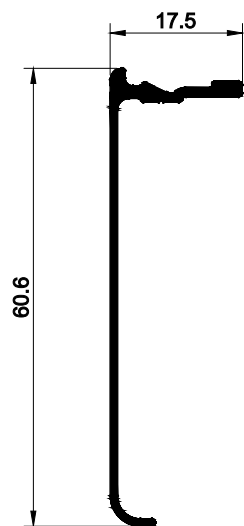

**EBX-034**  
0,257 kg/m

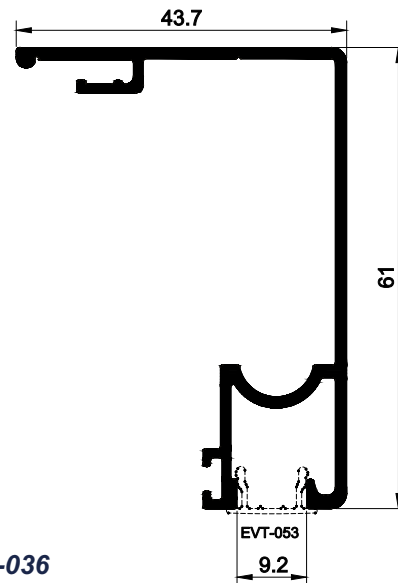

**EBX-036**  
0,668 kg/m

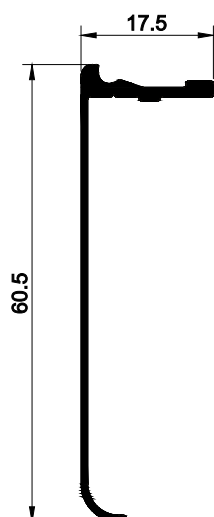

**EVT-714**  
0,244 kg/m

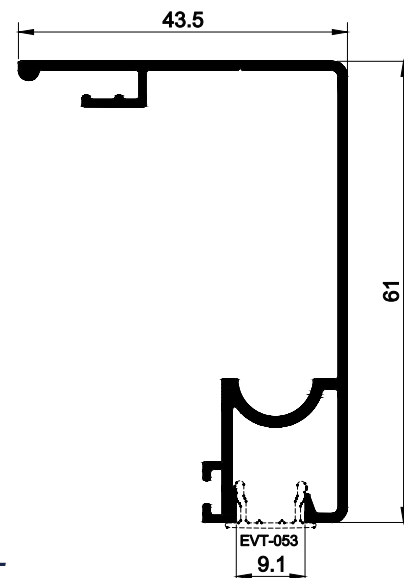

**EVT-713L**  
0,576 kg/m

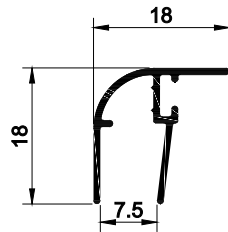

**EVT-055**  
0,136 kg/m

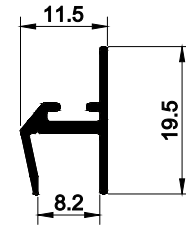

**EBX-104**  
0,135 kg/m

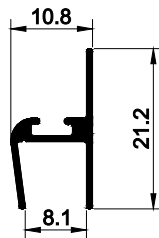

**EVT-075**  
0,114 kg/m

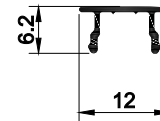

**EVT-053**  
0,047 kg/m

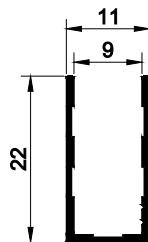

**EPU-556**  
0,127 kg/m

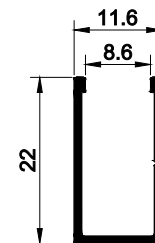

**EPU-553**  
0,150 kg/m

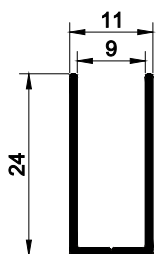

**EPU-552**  
0,154 kg/m

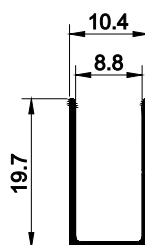

**EPU-551**  
0,103 kg/m

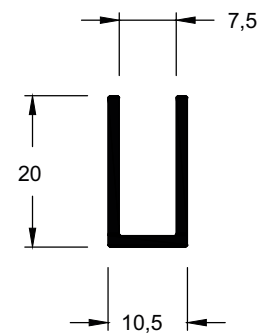

**EPU-008**  
0,192 kg/m

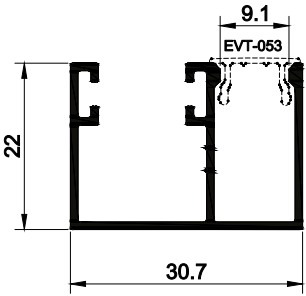
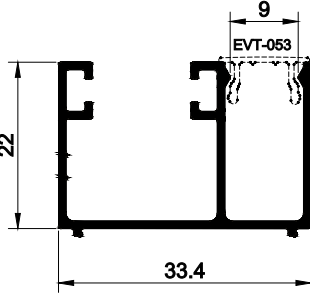
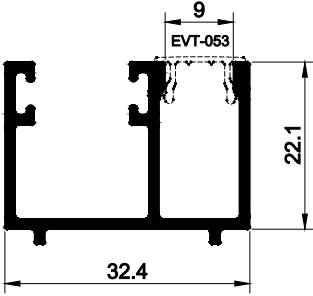
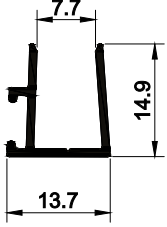
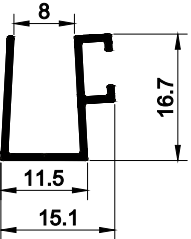
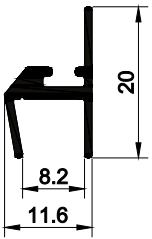
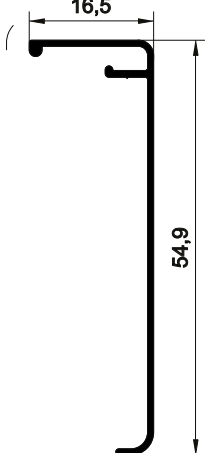
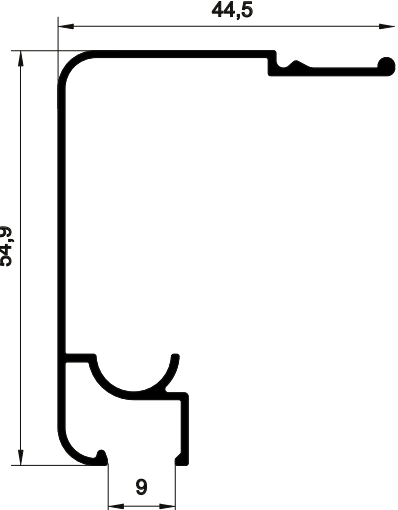
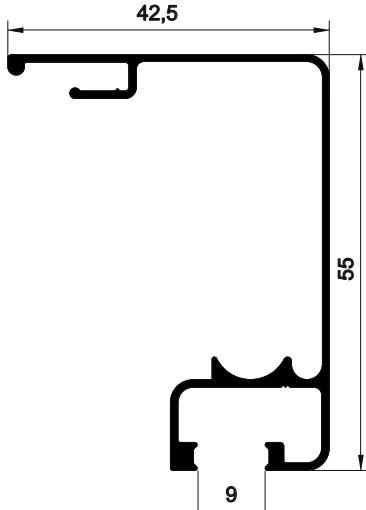
 <p><b>EBX-027</b> 0,310 kg/m</p>	 <p><b>EBX-038</b> 0,326 kg/m</p>	
 <p><b>EBX-120</b> 0,442 kg/m</p>	 <p><b>EBX-026</b> 0,123 kg/m</p>	
 <p><b>EBX-031</b> 0,131 kg/m</p>	 <p><b>EBX-025</b> 0,149 kg/m</p>	
 <p><b>EVT-020</b> 0,178 kg/m</p>	 <p><b>EVT-019</b> 0,362 kg/m</p>	 <p><b>EVT-081</b> 0,473 kg/m</p>



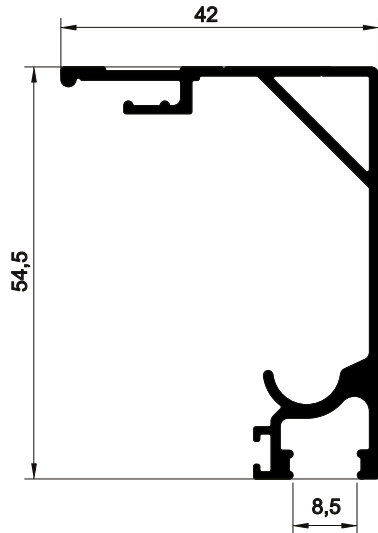

**EBX-041**  
0,618 kg/m

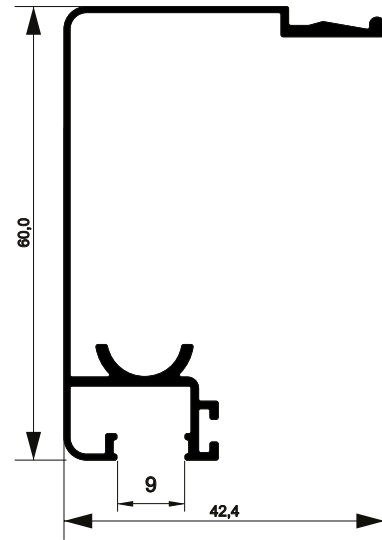

**EBX-042**  
0,428 kg/m

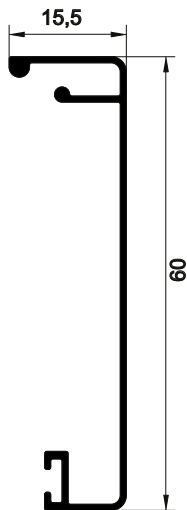

**EBX-043**  
0,244 kg/m

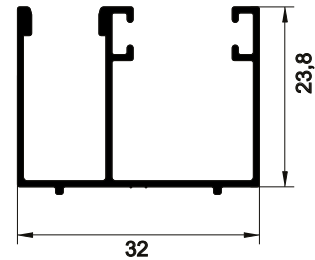

**EBX-044**  
0,279 kg/m

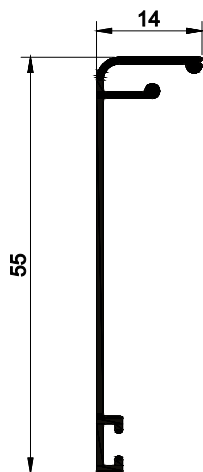

**EVT-003**  
0,210 kg/m

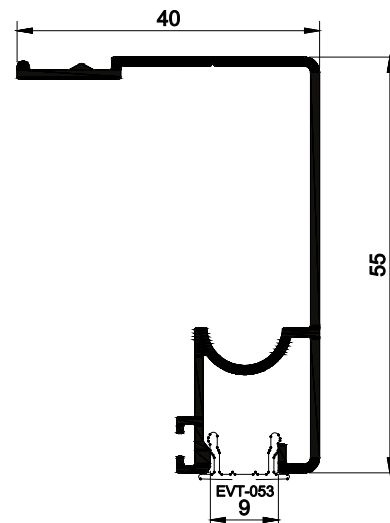

**EVT-008**  
0,483 kg/m

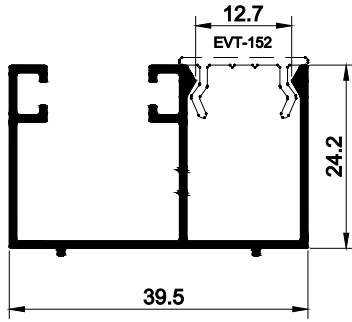

**EVT-150**  
0,371 kg/m

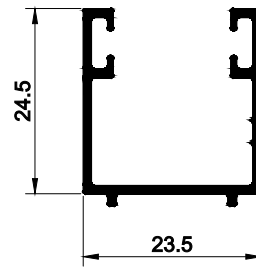

**EBX-030**  
0,274 kg/m

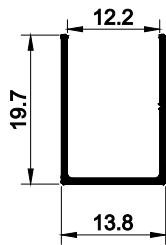

**EPU-554**  
0,111 kg/m

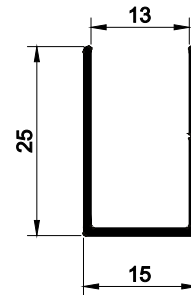

**EPU-555**  
0,170 kg/m

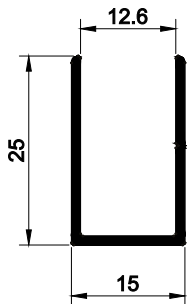

**EPU-557**  
0,202 kg/m

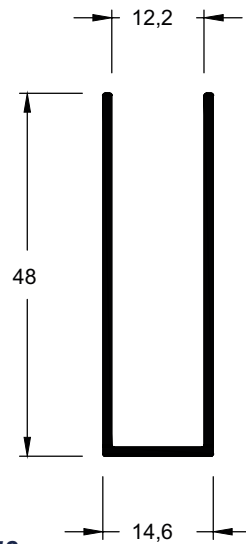

**EPU-558**  
0,351 kg/m

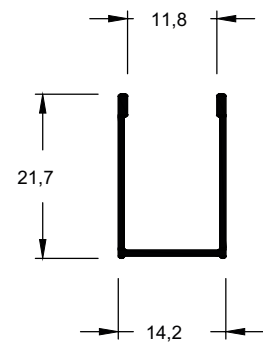

**EPU-559**  
0,127 kg/m

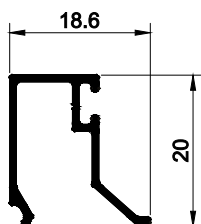

**EVT-155**  
0,150 kg/m

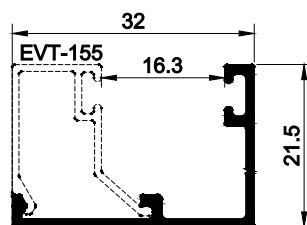

**EVT-154**  
0,212 kg/m

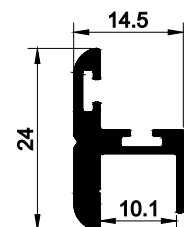

**EVT-153**  
0,270 kg/m

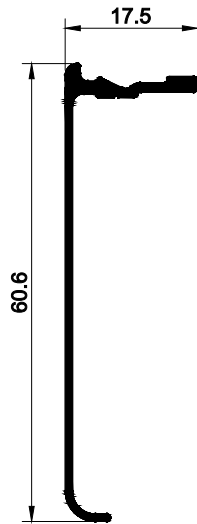

**EBX-034**  
0,257 kg/m



**EVT-009**  
0,263 kg/m

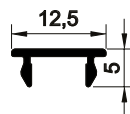

**EVT-018**  
0,055 kg/m

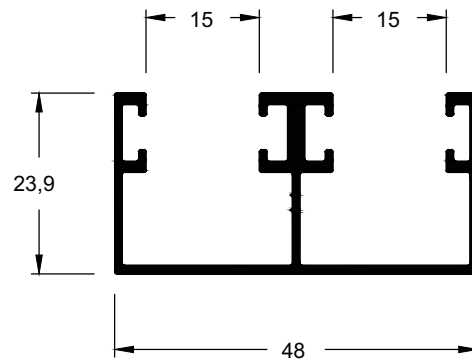

**EVT-028**  
0,515 kg/m

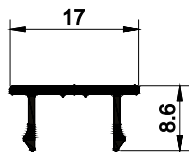

**EBX-491**  
0,086 kg/m

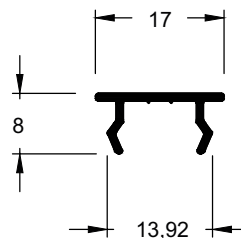

**EVT-152**  
0,087 kg/m

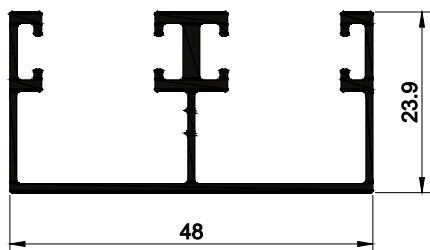

**EBX-280**  
0,510 kg/m

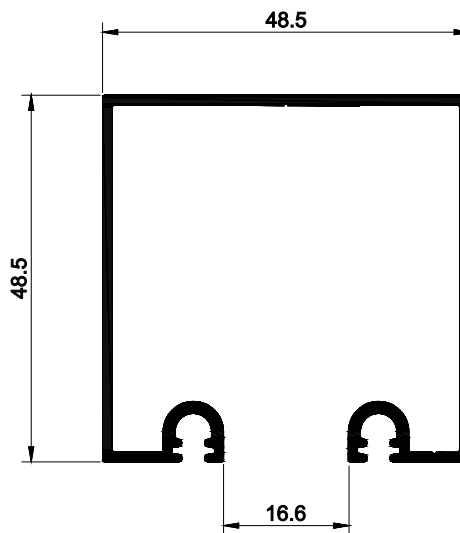

**EVT-002**  
0,723 kg/m

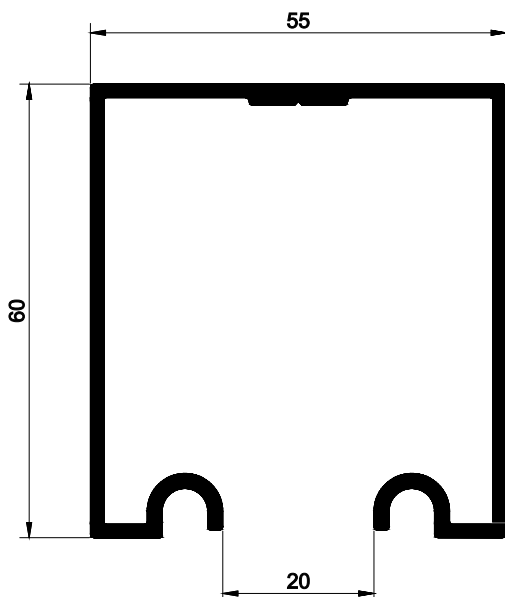

**EVT-010**  
1,126 kg/m

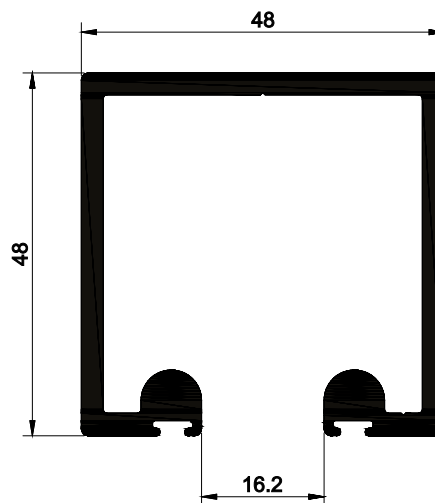

**EVT-006**  
1,458 kg/m

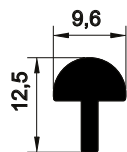

**EPO-301**  
0,161 kg/m

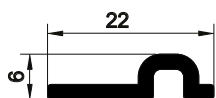

**EPO-302**  
0,152 kg/m

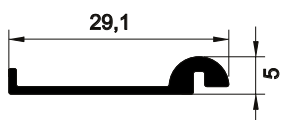

**EPO-305**  
0,130 kg/m

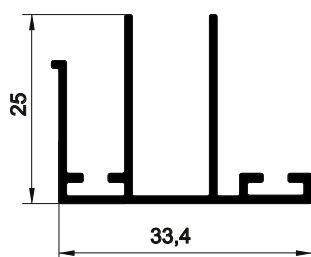

**EPO-303**  
0,317 kg/m

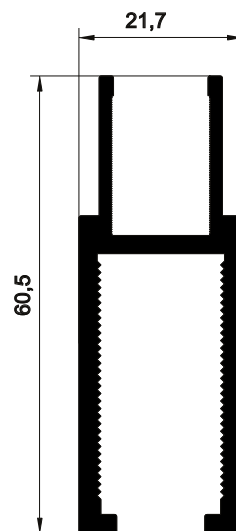

**EPO-300**  
0,932 kg/m

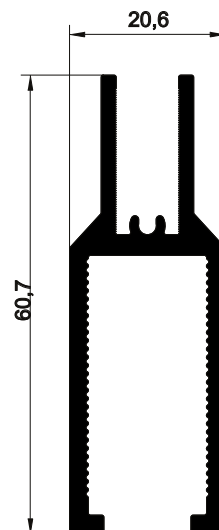

**EPO-306**  
0,900 kg/m

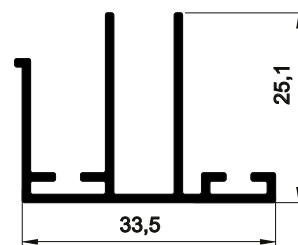

**EPO-304**  
0,348 kg/m



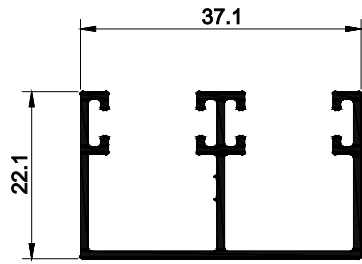

**EVT-1493**  
0,360 kg/m

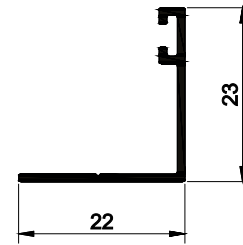

**EVT-1494**  
0,138 kg/m

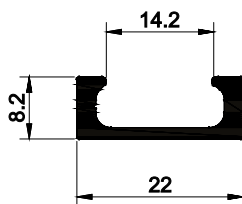

**EVT-1492**  
0,196 kg/m

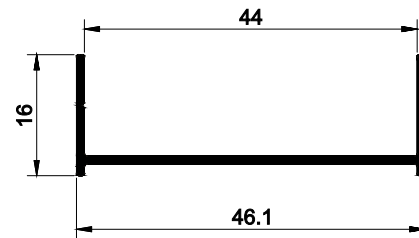

**EPU-399**  
0,222 kg/m

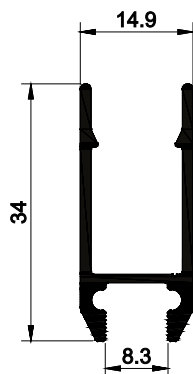

**EVT-1491**  
0,303 kg/m

CONTRA MARCO

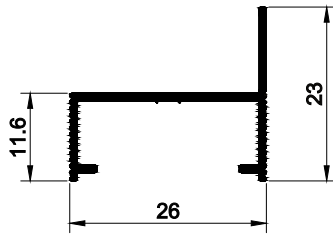

**ECM-200**  
0,166 kg/m

CONTRA MARCO

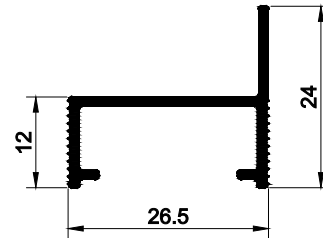

**ECM-063**  
0,223 kg/m

CONTRA MARCO

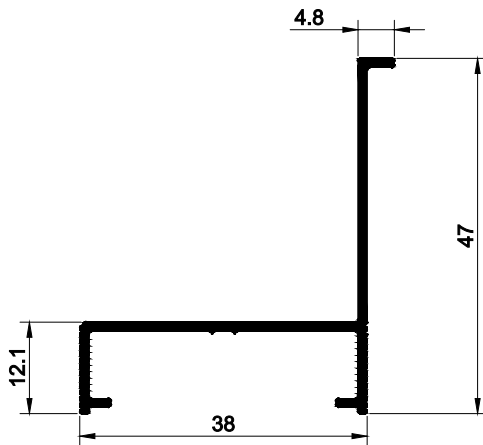

**ECM-098**  
0,329 kg/m

CONTRA MARCO

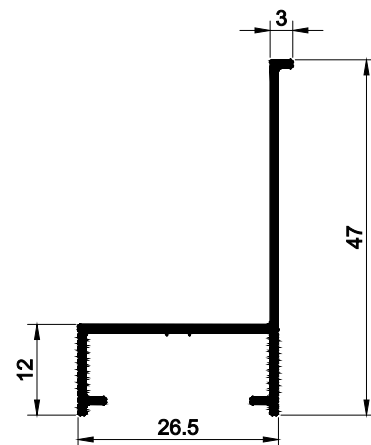

**ECM-151**  
0,262 kg/m

CONTRA MARCO

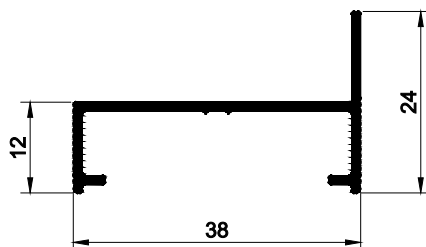

**ECM-060**  
0,245 kg/m

CONTRA MARCO

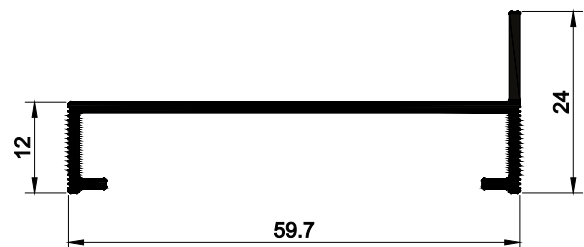

**ECM-174**  
0,371 kg/m

**MACHO**

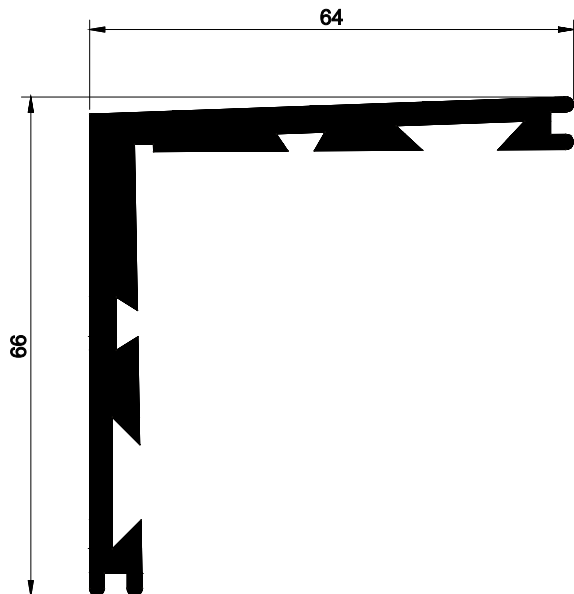

**ECL-009**  
1,666 kg/m

**CUNHA**

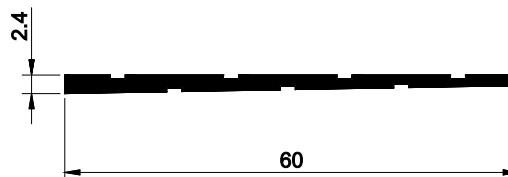

**ECL-010**  
0,293 kg/m

**MACHO**

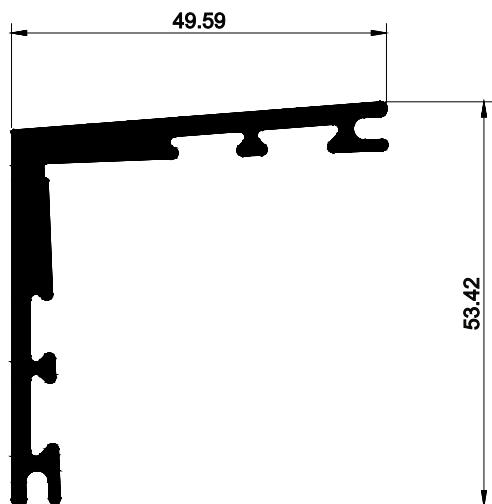

**ECL-006**  
1,040 kg/m

**CUNHA**

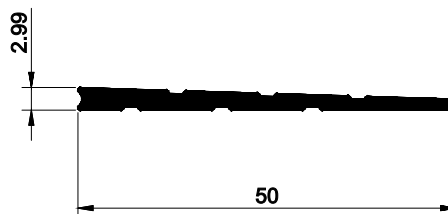

**ECL-011**  
0,287 kg/m

**ARREMATE**

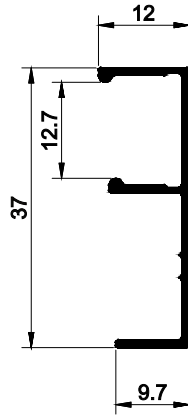

**EMP-347**  
0,183 kg/m

**ARREMATE**

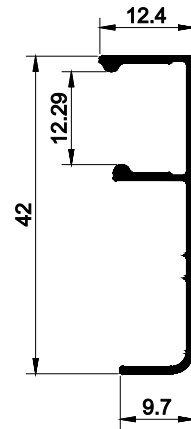

**EMN-014**  
0,190 kg/m

**ARREMATE PISO**

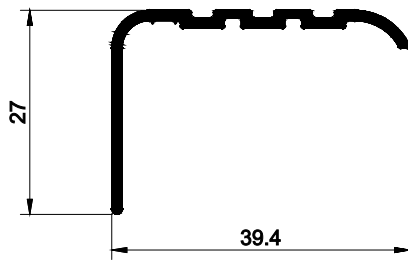

**EME-013**  
0,261 kg/m

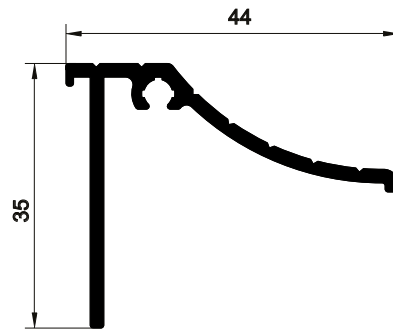

**ECM-169**  
0,431 kg/m

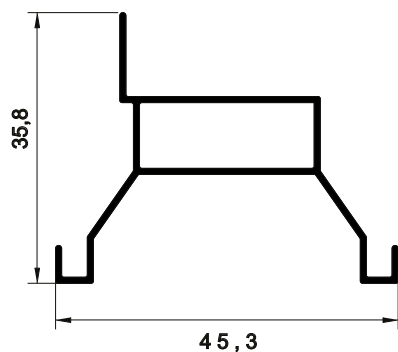

**ECP-001**  
0,279 kg/m

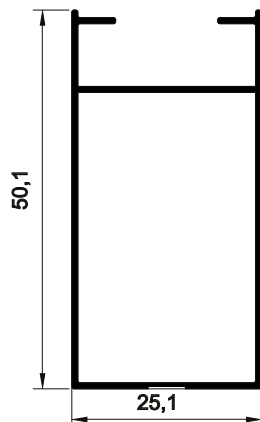

**ECP-002**  
0,340 kg/m

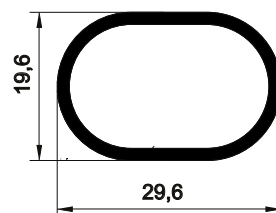

**ECP-003**  
0,083 kg/m

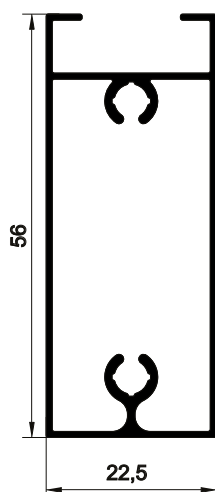

**ECP-004**  
0,463 kg/m

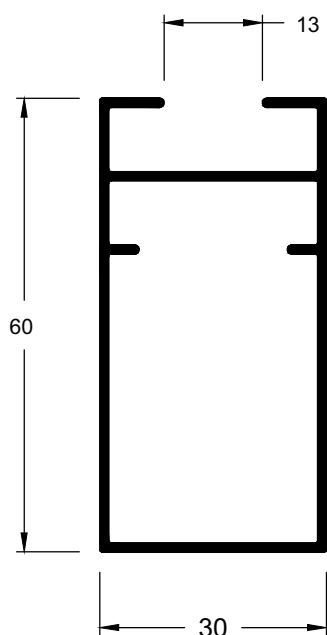

**ECP-060**  
0,641 kg/m

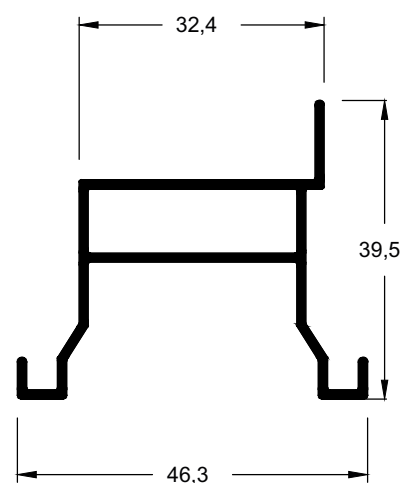

**ECP-061**  
0,476 kg/m

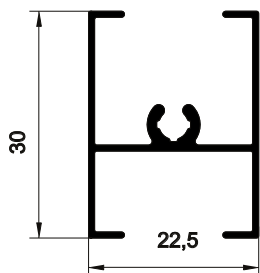

**ECP-005**  
0,260 kg/m

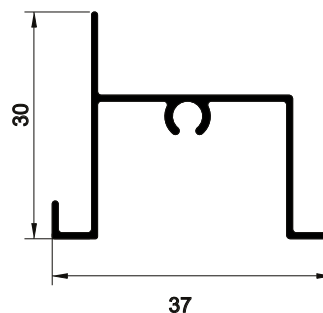

**ECP-011**  
0,229 kg/m

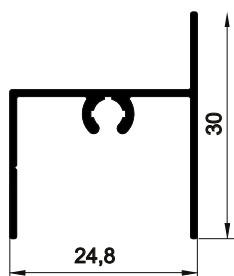

**ECP-066**  
0,199 kg/m

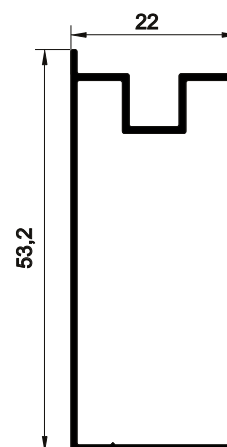

**ECP-070**  
0,364 kg/m



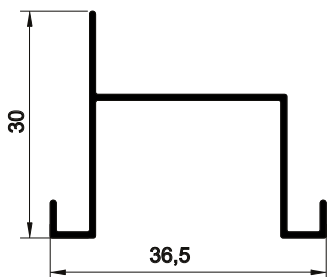

**ECP-016**  
0,199 kg/m

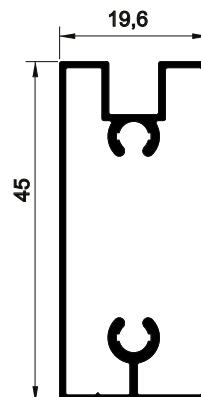

**ECP-071**  
0,413 kg/m

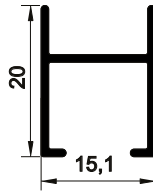

**ECP-025**  
0,155 kg/m

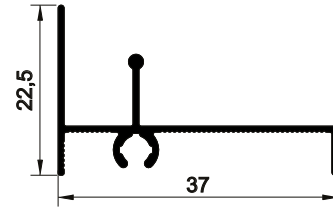

**ECP-026**  
0,189 kg/m

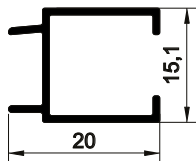

**ECP-027**  
0,142 kg/m

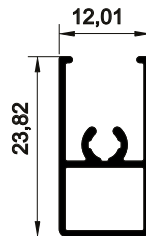

**ECP-028**  
0,178 kg/m

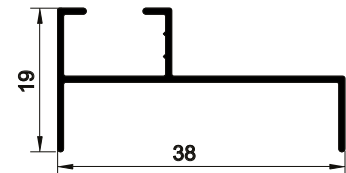

**ECP-039**  
0,173 kg/m

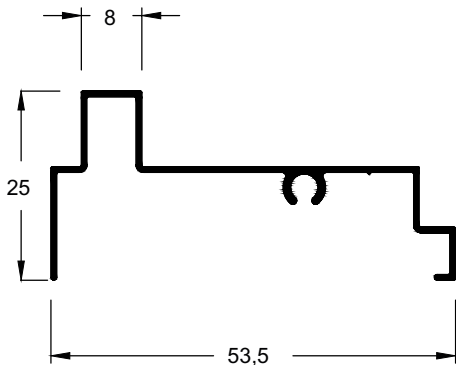

**ECP-045**  
0,237 kg/m

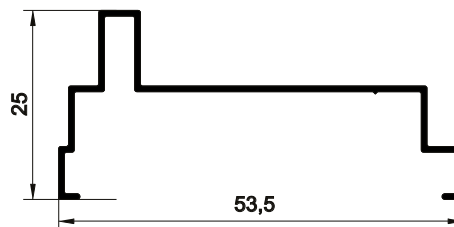

**ECP-046**  
0,215 kg/m

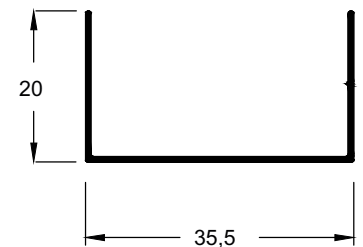

**ECP-047**  
0,150 kg/m

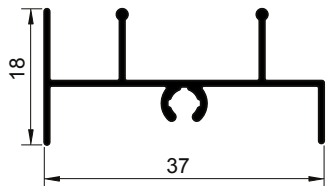

**ECP-008**  
0,279 kg/m

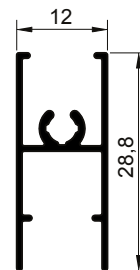

**ECP-009**  
0,340 kg/m

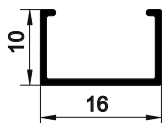

**ECP-010**  
0,079 kg/m

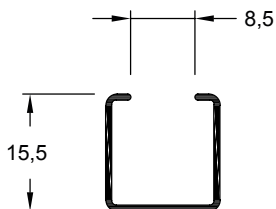

**ECP-007**  
0,102 kg/m

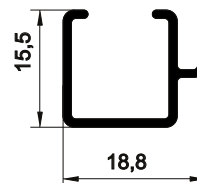

**ECP-024**  
0,160 kg/m

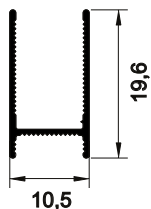

**ECP-067**  
0,089 kg/m

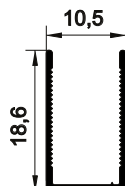

**ECP-068**  
0,089 kg/m

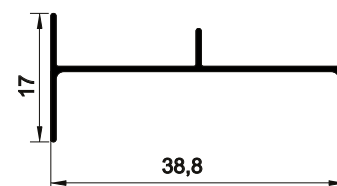

**ECP-006**  
0,146 kg/m

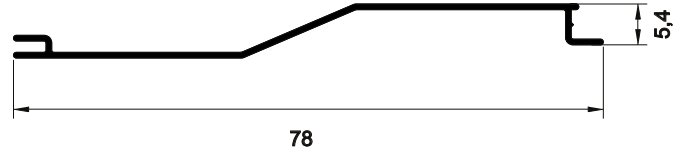

**ECP-072**  
0,185 kg/m

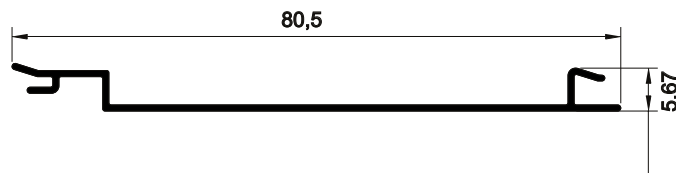

**ECP-073**  
0,216 kg/m

VENEZIANA

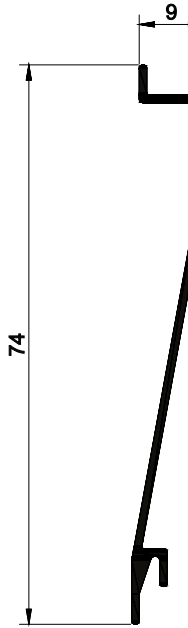

**EVZ-024**  
0,254 kg/m

VENEZIANA

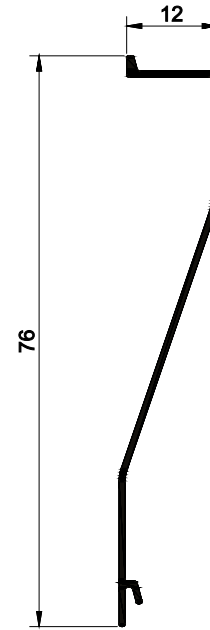

**EVZ-169**  
0,203 kg/m

VENEZIANA

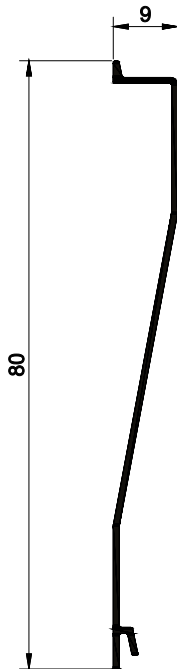

**EVZ-0620**  
0,201 kg/m

VENEZIANA

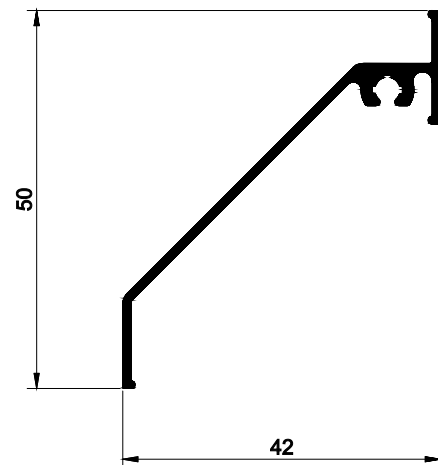

**EVZ-047**  
0,298 kg/m

VENEZIANA

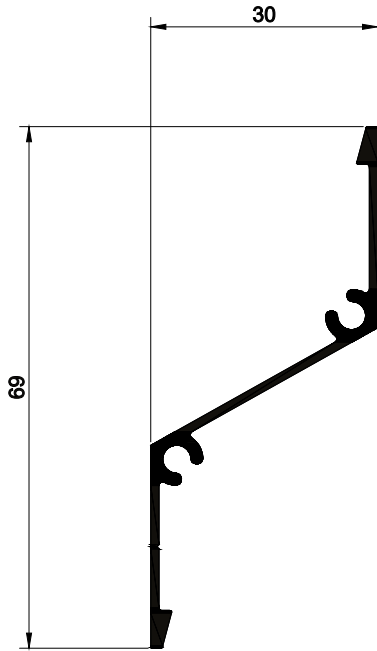

**EVZ-060**  
0,357 kg/m

VENEZIANA

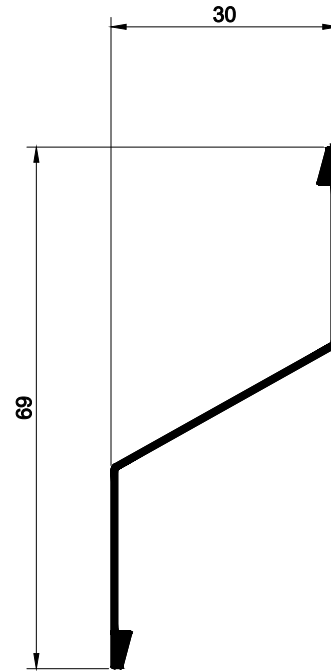

**EVZ-060L**  
0,244 kg/m

VENEZIANA

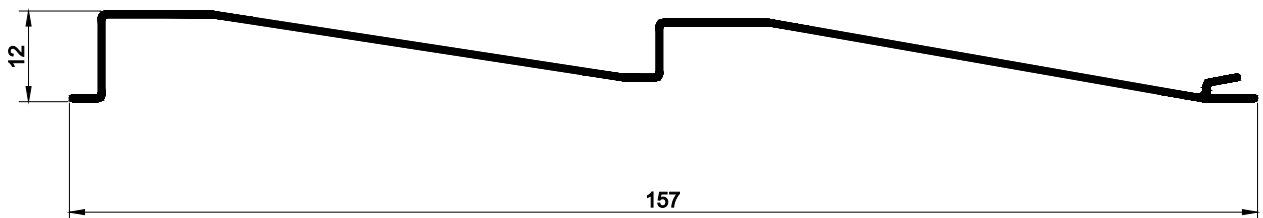

**EVZ-075**  
0,440 kg/m

## VENEZIANA

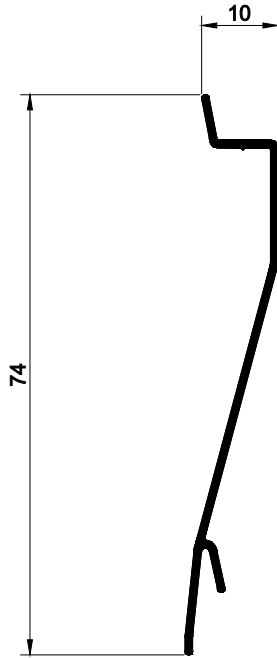

**EVZ-051 (Z-284/E)**  
0,244 kg/m

## VENEZIANA VENTILADA

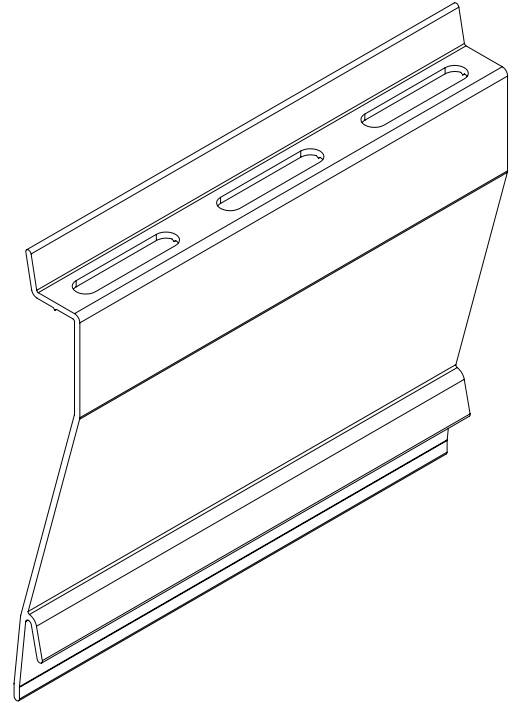

**EUS-294**  
0,244 kg/m

## VENEZIANA

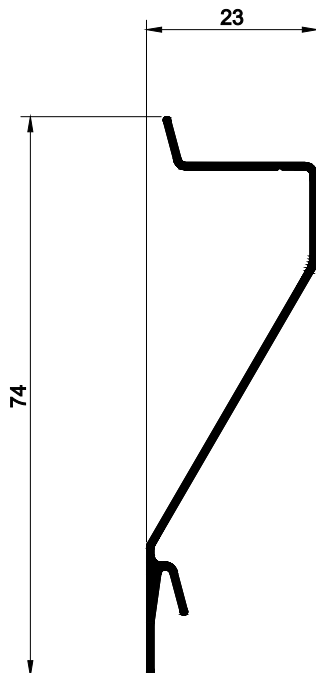

**EVZ-203**  
0,295 kg/m

## VENEZIANA VENTILADA

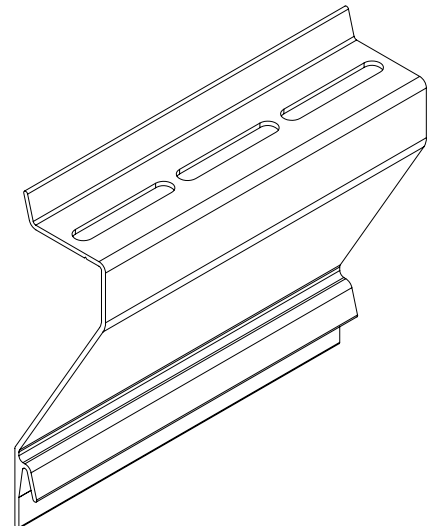

**EUS-294**  
0,295 kg/m

## VENEZIANA

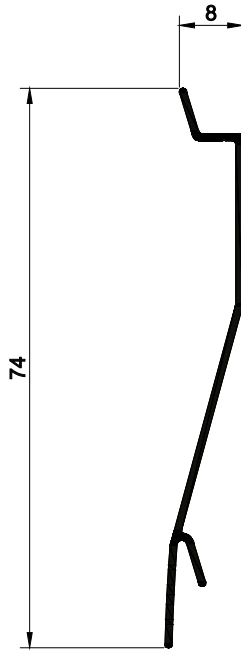

**EVZ-201**  
0,227 kg/m

## VENEZIANA VENTILADA

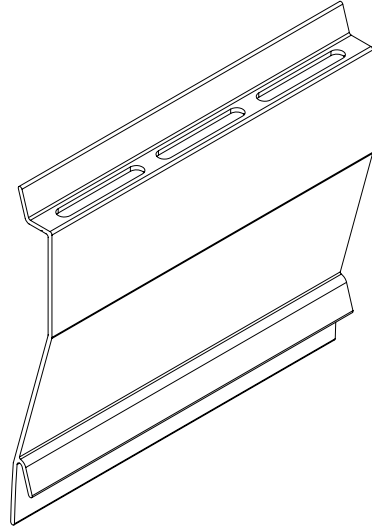

**EUS-201**  
0,227 kg/m

## VENEZIANA

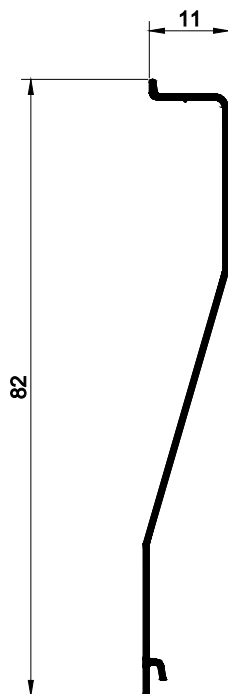

**EVZ-221**  
0,209 kg/m

## VENEZIANA

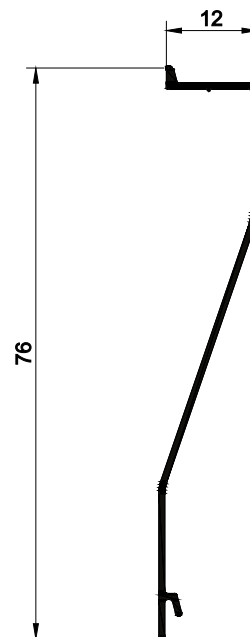

**EVZ-169**  
0,203 kg/m



**PERFIL MATA JUNTA**

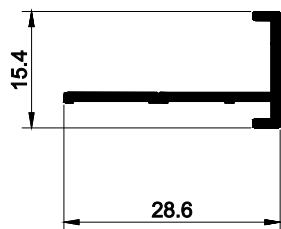

**E25-100**  
0,156 kg/m

**PERFIL MATA JUNTA / GIRO**

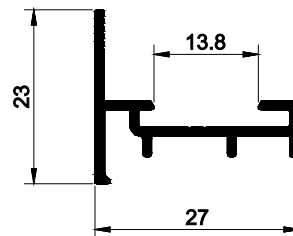

**E25-099**  
0,229 kg/m

**PERFIL TELA MOSQUITEIRA**

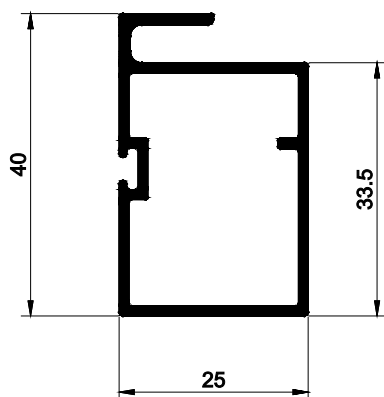

**E25-549**  
0,507 kg/m

**PERFIL MATA JUNTA**

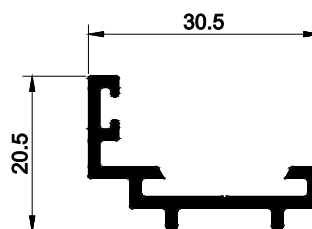

**E25-548**  
0,281 kg/m

**BAGUETE**

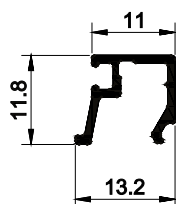

**EBG-001**  
0,103 kg/m

**PERFIL FOLHA / MAXIM-AR**

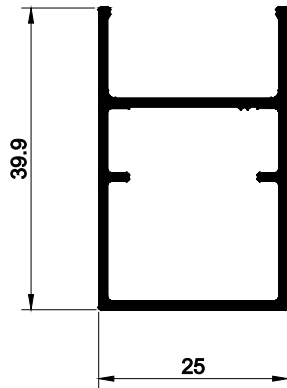
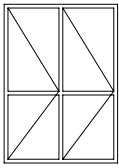

**E25-312**  
0,431 kg/m

**PERFIL FOLHA / GIRO**

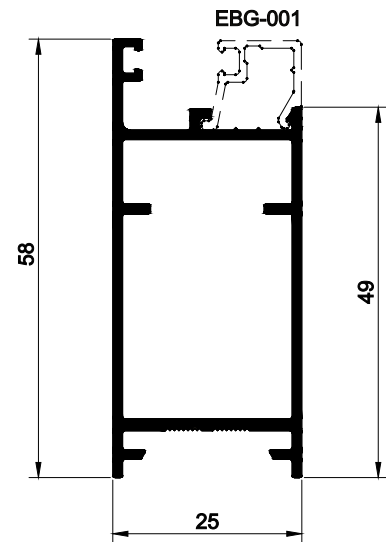
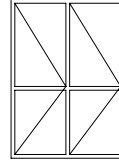

**E25-023**  
0,629 Kg/m

**PERFIL TRAVESSA FOLHA / GIRO**

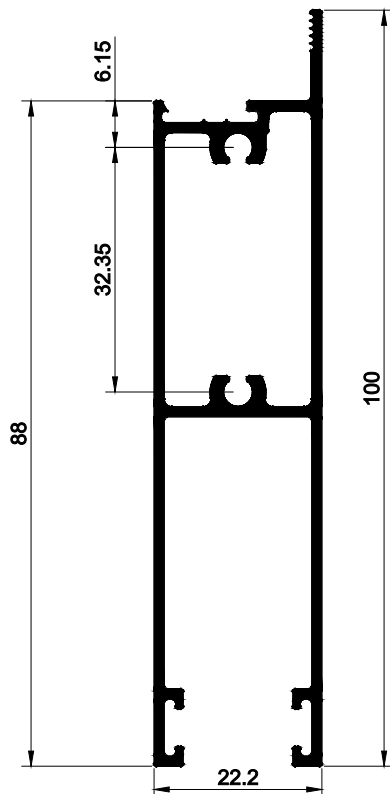
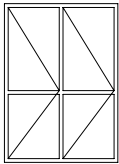

**E25-101**  
0,992 kg/m

**MARCO / GIRO**

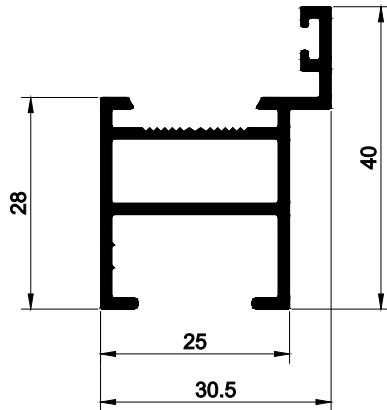
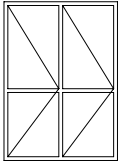

**E25-024**  
0,542 kg/m

**MARCO / GIRO**

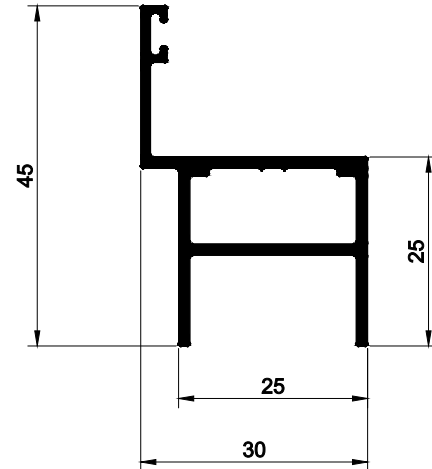
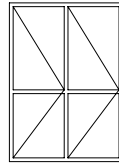

**E25-522**  
0,504 Kg/m

**PERFIL FOLHA / GIRO**

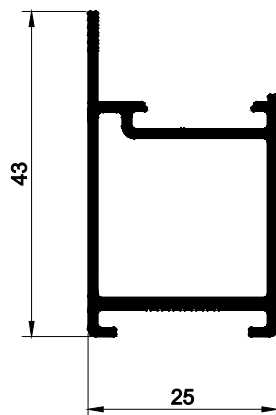
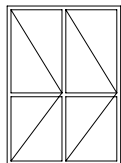

**E25-120**  
0,482 kg/m

**TRAVESSA / GIRO**

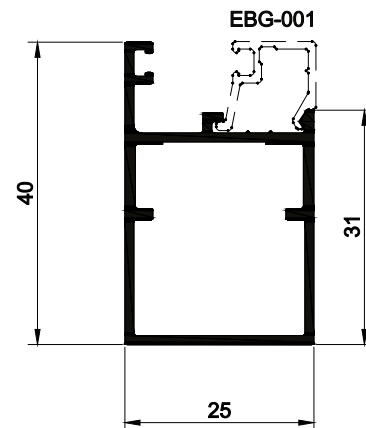
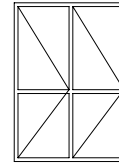

**E25-011**  
0,448 Kg/m

**MARCO / MAXIM-AR**

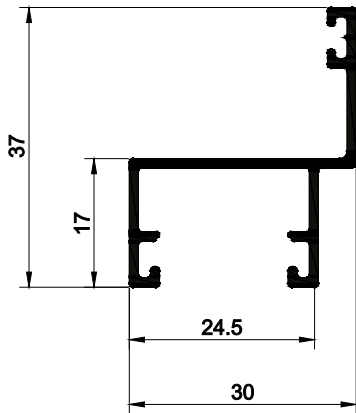

**E25-002**  
0,333 kg/m

**PERFIL FOLHA / MAXIM-AR**

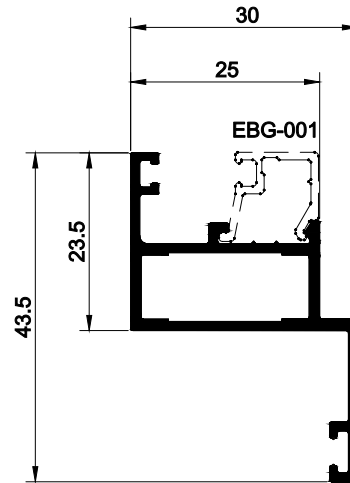

**E25-005**  
0,431 Kg/m

**PERFIL FOLHA / MAXIM-AR**

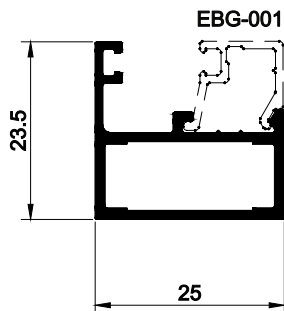

**E25-004**  
0,312 kg/m

**PERFIL FOLHA / MAXIM-AR**

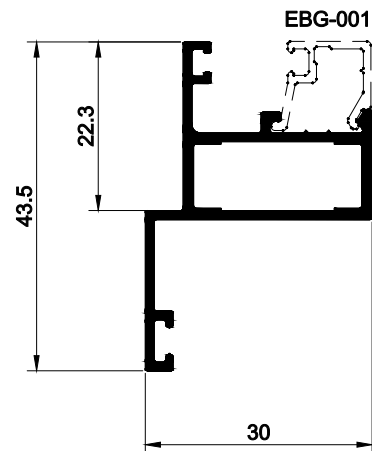

**E25-006**  
0,431 Kg/m

**COLUNA / MAXIM-AR**

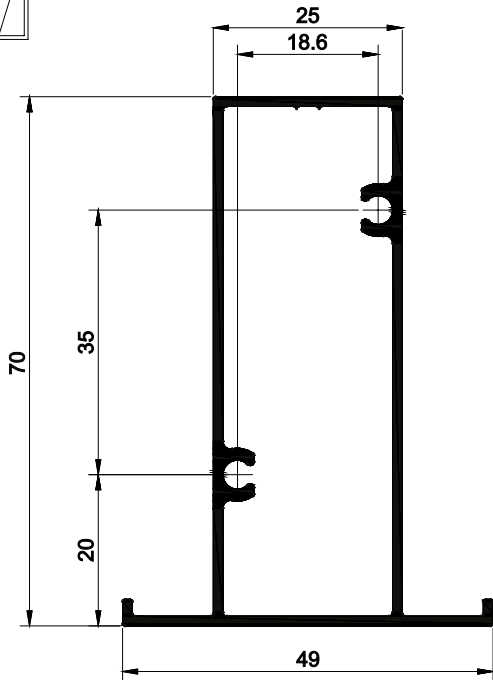
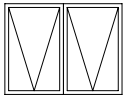

**EFC-070**  
0,835 kg/m

**PERFIL MÃO DE AMIGO / CORRER**

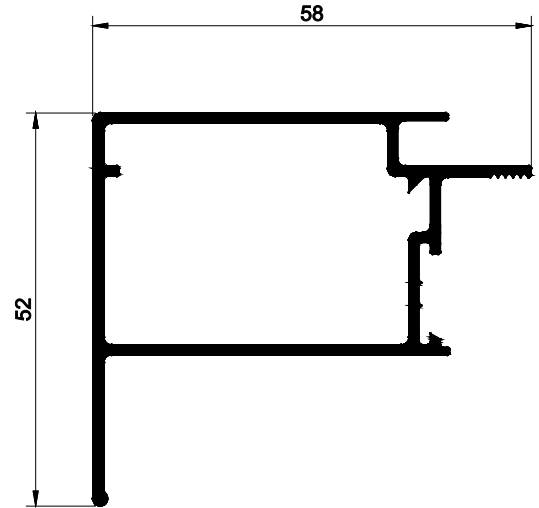
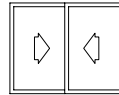

**E25-036**  
0,749 Kg/m

**TRAVESSA INFERIOR E SUPERIOR / CORRER**

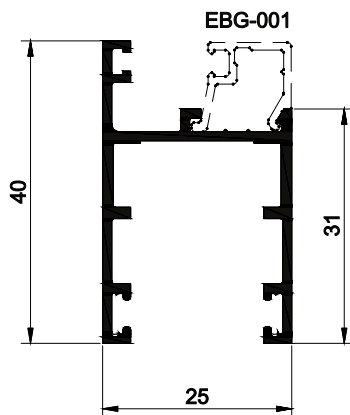
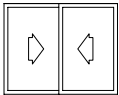

**E25-014**  
0,417 kg/m

**TRAVESSA INFERIOR E SUPERIOR / CORRER**

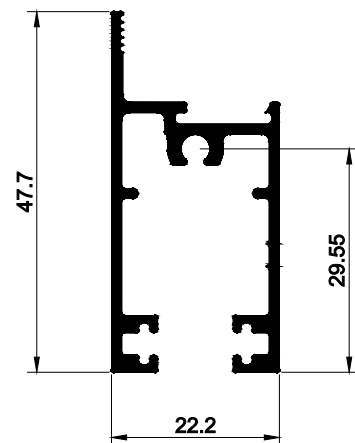
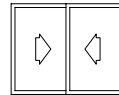

**E25-102**  
0,550 Kg/m

**TRAVESSA INFERIOR E SUPERIOR / CORRER**

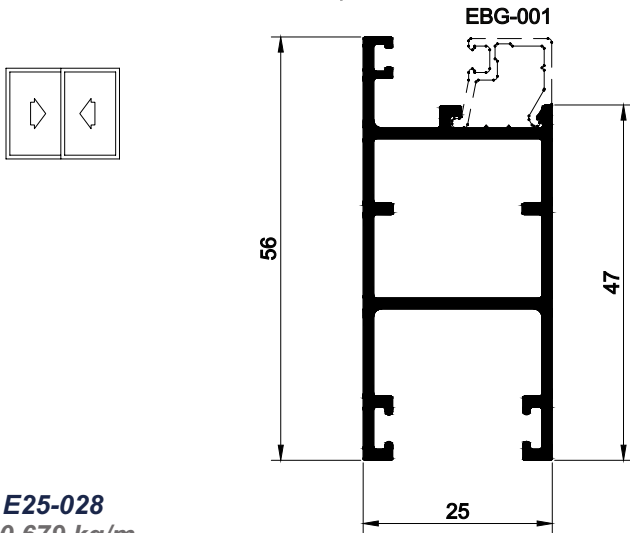

**E25-028**  
0,679 kg/m

**TRAVESSA INFERIOR E SUPERIOR / CORRER**

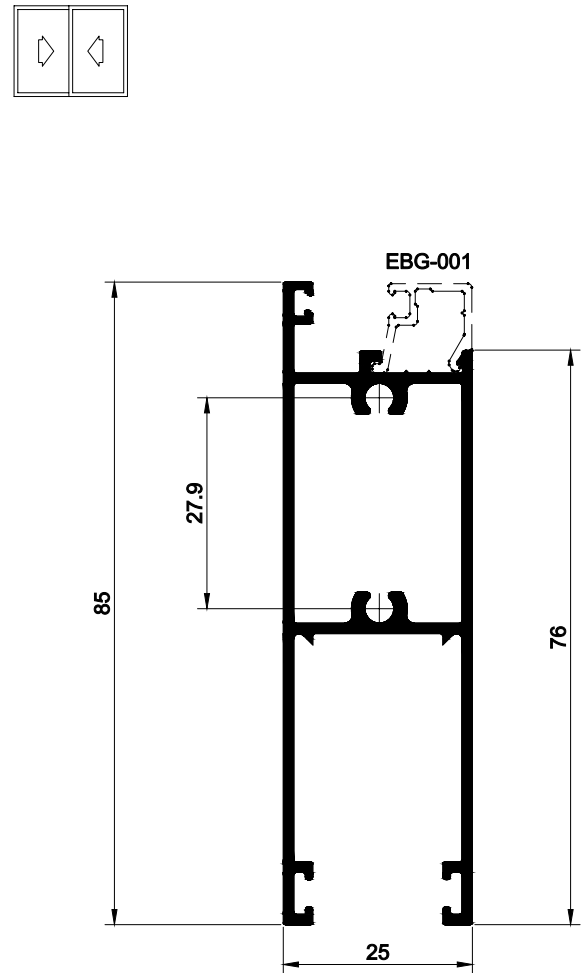

**E25-029**  
0,959 kg/m

**PERFIL FOLHA / MAXIM-AR**

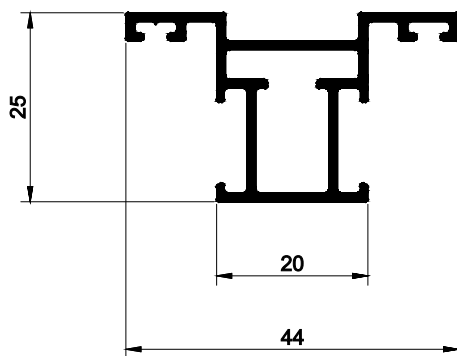

**E25-308**  
0,454 kg/m

**COLUNA / MAXIM-AR**

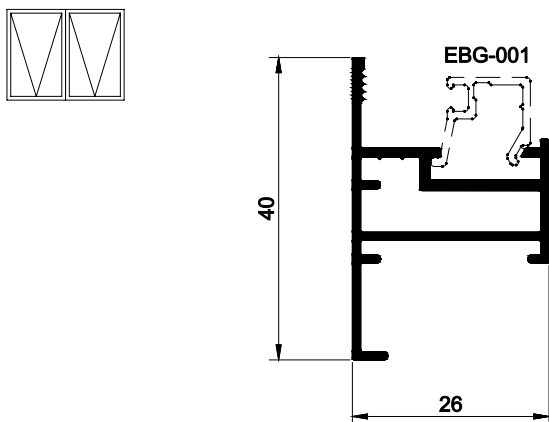

**E25-052**  
0,390 kg/m

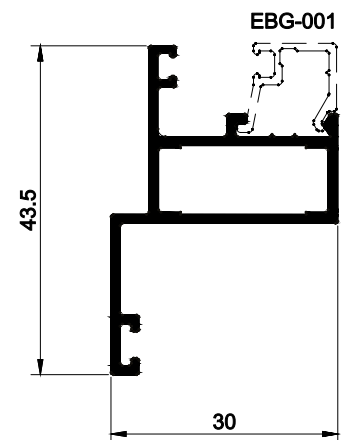

**E25-205**  
0,421 kg/m

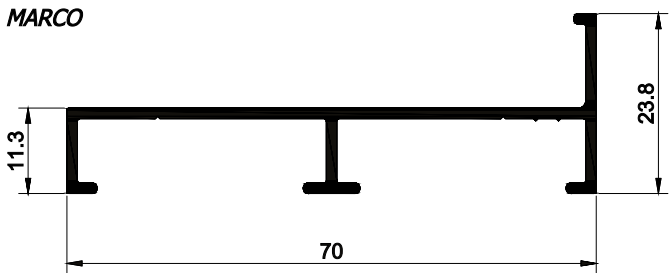
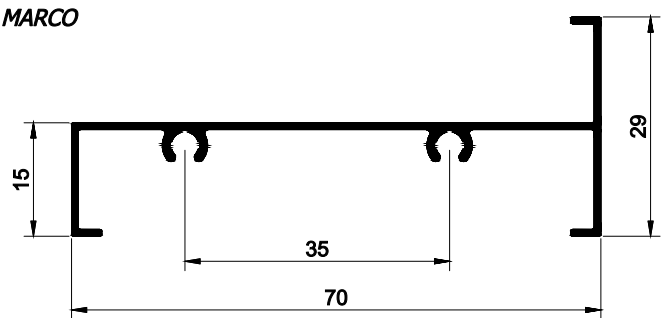
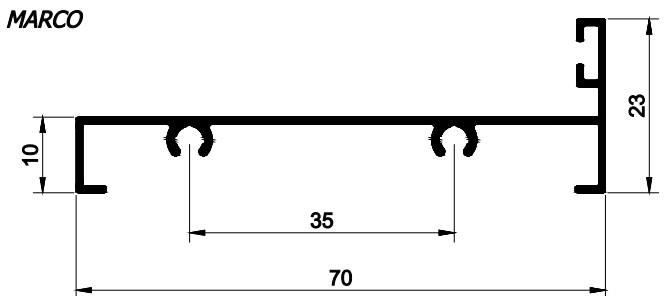
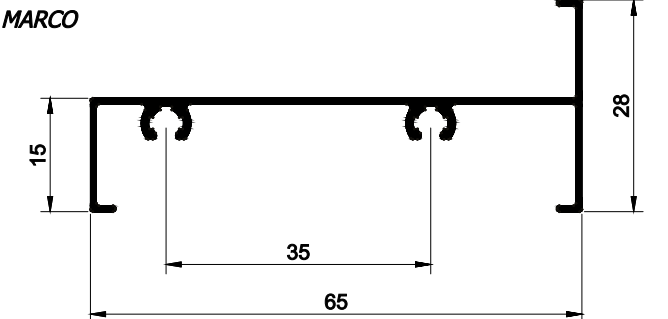
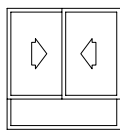
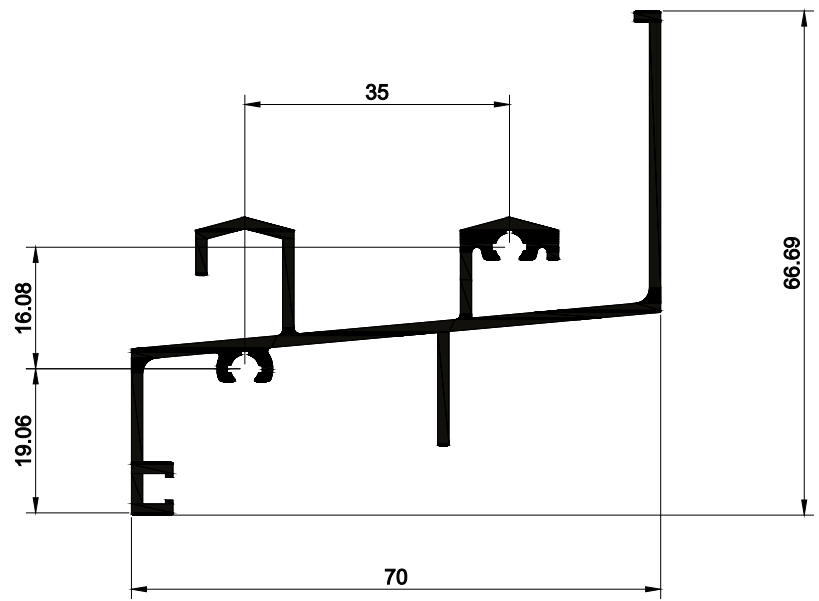
<p><b>MARCO</b></p>  <p><b>E25-165</b> 0,473 kg/m</p>	<p><b>MARCO</b></p>  <p><b>E25-175</b> 0,357 Kg/m</p>
<p><b>MARCO</b></p>  <p><b>E25-176</b> 0,347 kg/m</p>	<p><b>MARCO</b></p>  <p><b>E25-177</b> 0,322 Kg/m</p>
<p><b>TRILHO DOIS PLANOS COM PEITORIL / CORRER</b></p>   <p><b>E25-034</b> 0,958 kg/m</p>	

**PERFIL MÃO DE AMIGO / CORRER**

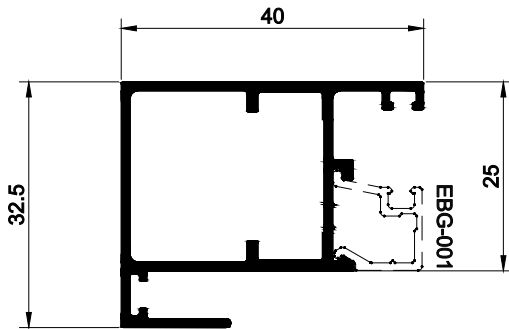
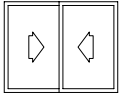

**E25-012**  
0,526 kg/m

**PERFIL MÃO DE AMIGO / CORRER**

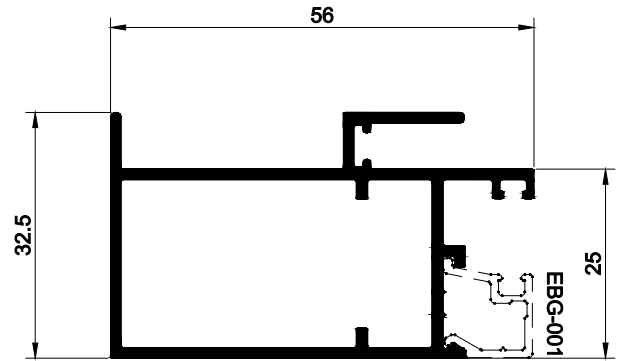
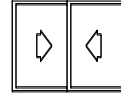

**E25-506**  
0,740 Kg/m

**PERFIL MÃO DE AMIGO / CORRER**

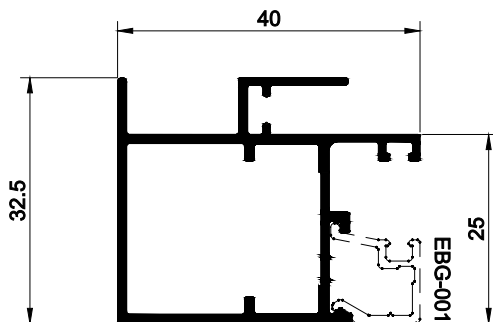
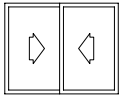

**E25-215**  
0,518 kg/m

**PERFIL MÃO DE AMIGO / CORRER**

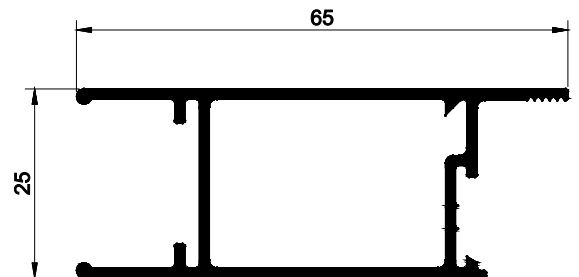
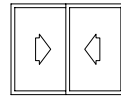

**E25-033**  
0,655 Kg/m



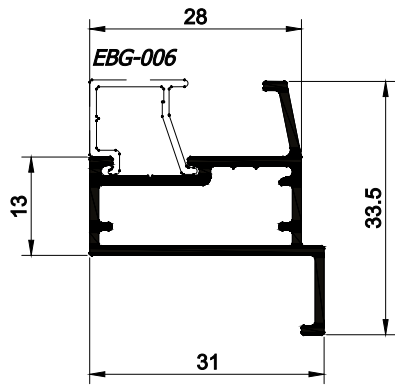

**E28-003**  
0,375 kg/m

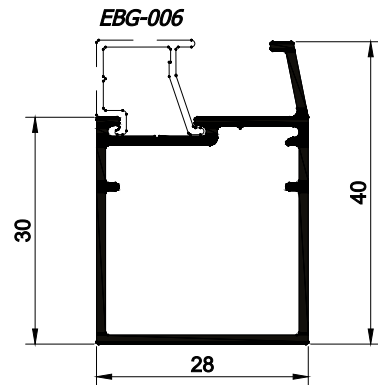

**E28-005**  
0,436 kg/m

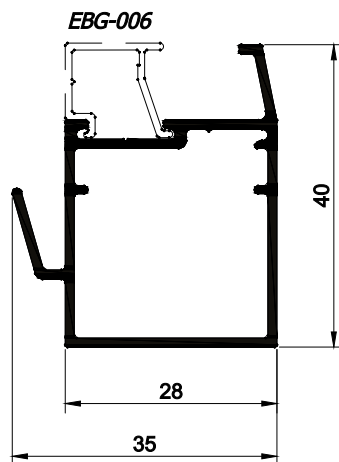

**E28-007**  
0,485 kg/m

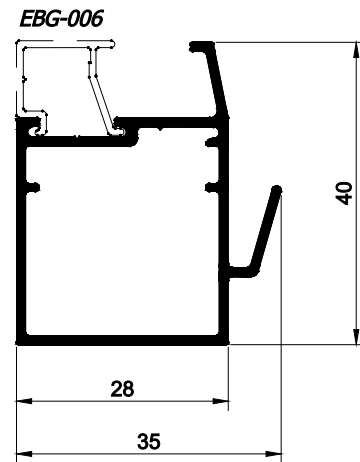

**E28-008**  
0,485 kg/m

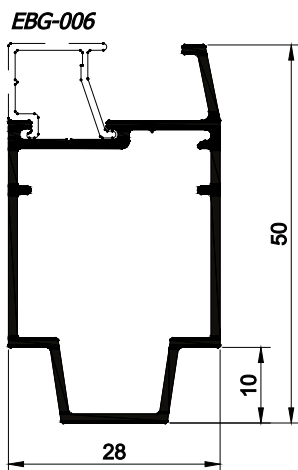

**E28-009**  
0,493 kg/m

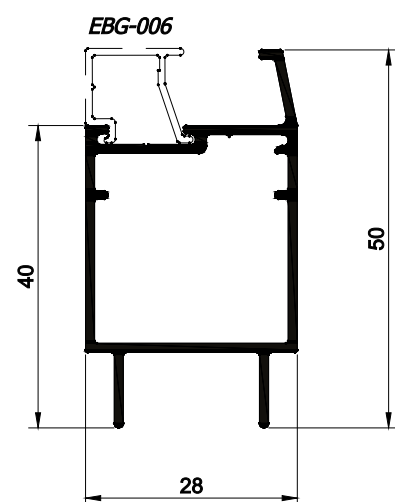

**E28-010**  
0,501 kg/m

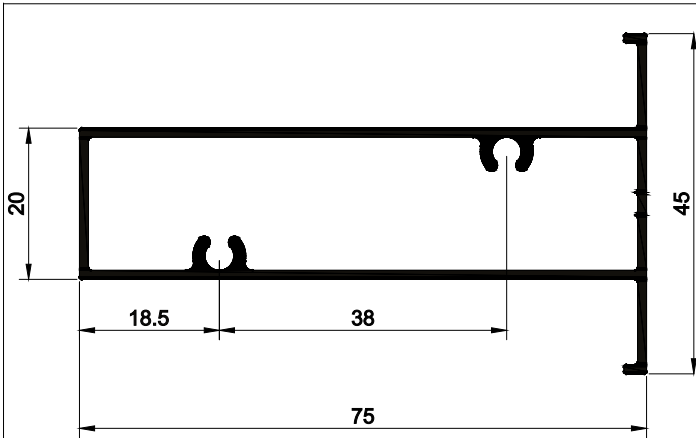

**E28-016**  
0,783 kg/m

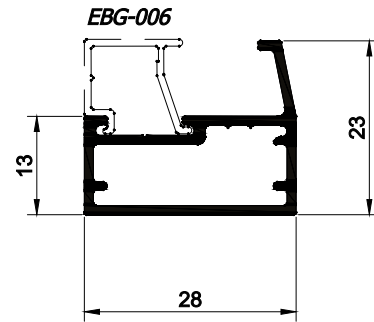

**E28-017**  
0,325 kg/m

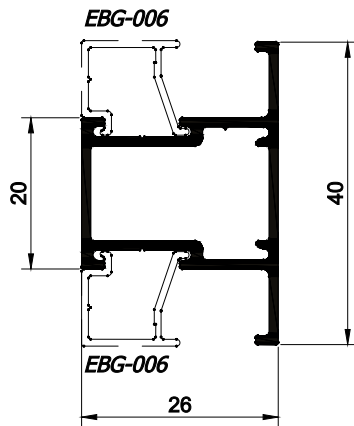

**E28-028**  
0,412 kg/m

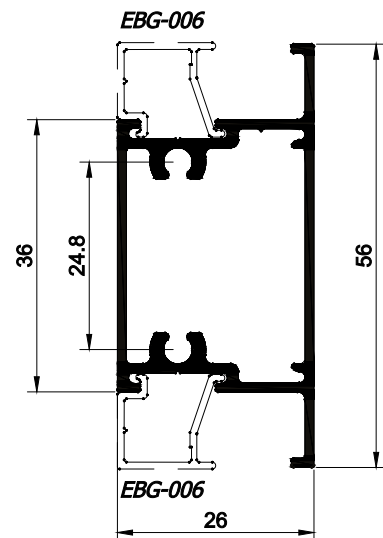

**E28-589**  
0,607 kg/m

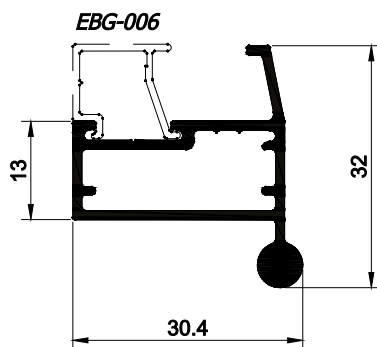

**E28-048**  
0,415 kg/m

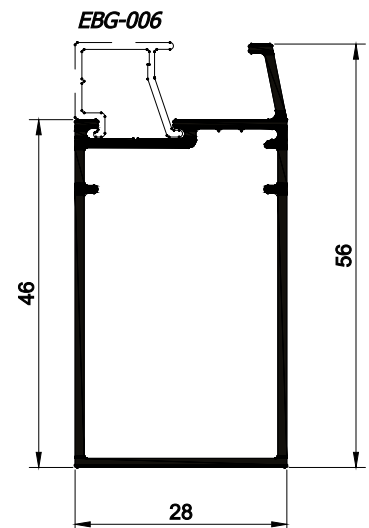

**E28-012**  
0,542 kg/m

FOLHA

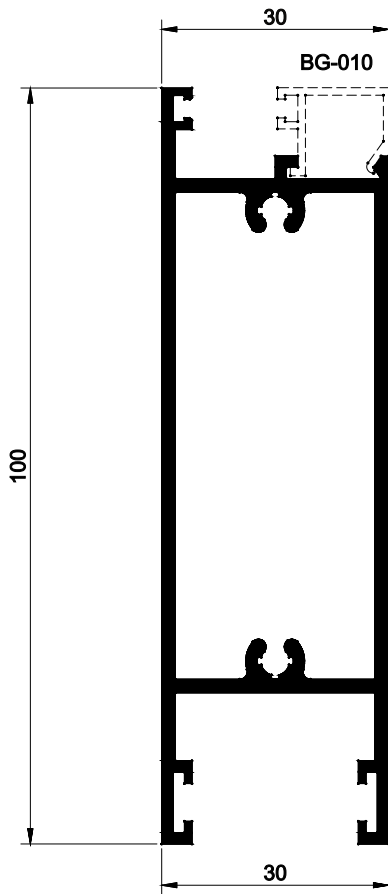

**E30-028**  
0,378 kg/m

FOLHA

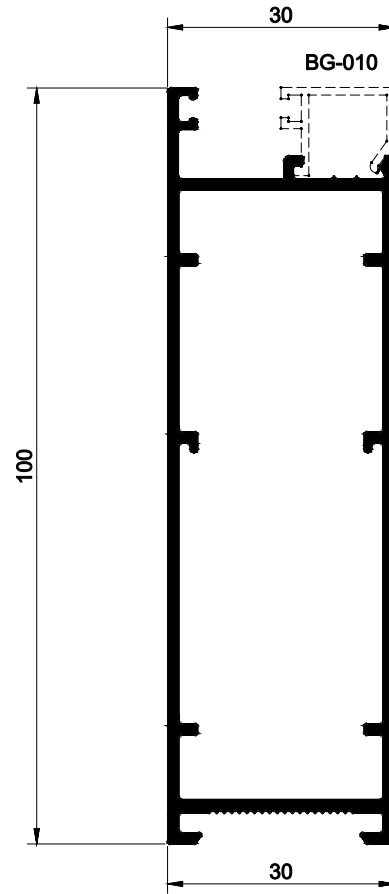

**E30-082**  
1,128 kg/m

BAGUETE

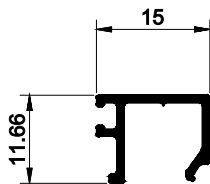

**EBG-010**  
0,114 kg/m

**TRAVESSA**

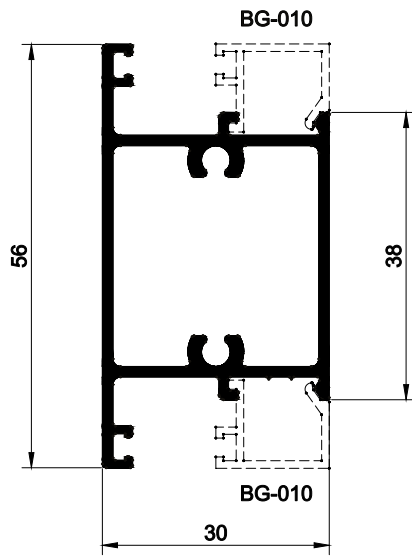

**E30-025**  
0,718 kg/m

**FOLHA**

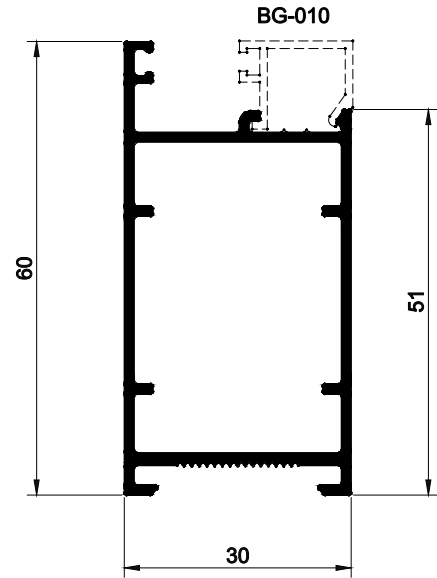

**E30-026**  
0,694 kg/m

**FOLHA**

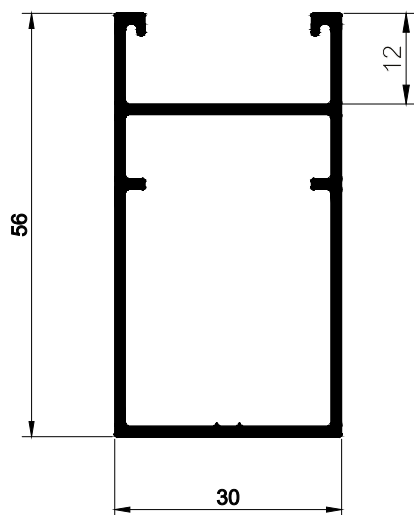

**E30-014**  
0,680 kg/m

**FOLHA**

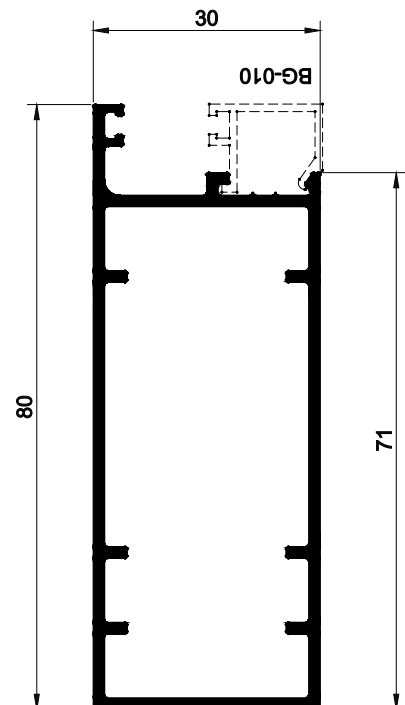

**E30-033**  
0,944 kg/m

MARCO

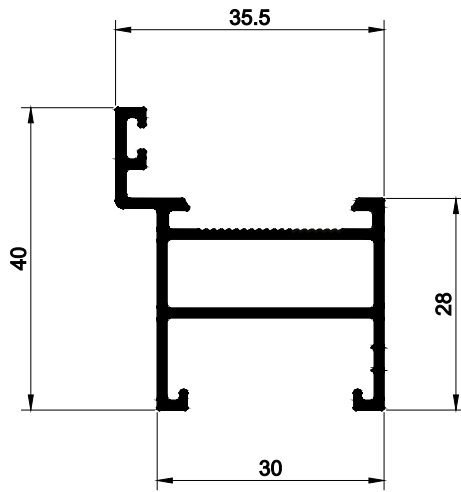

**E30-023**  
0,525 kg/m

MARCO

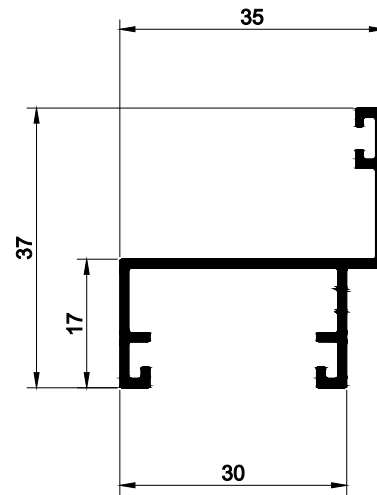

**E30-054**  
0,352 kg/m

FOLHA

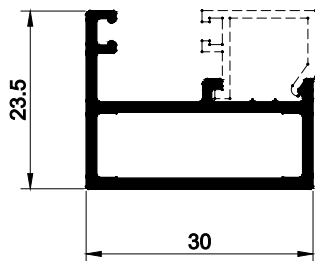

**E30-051**  
0,385 kg/m

FOLHA

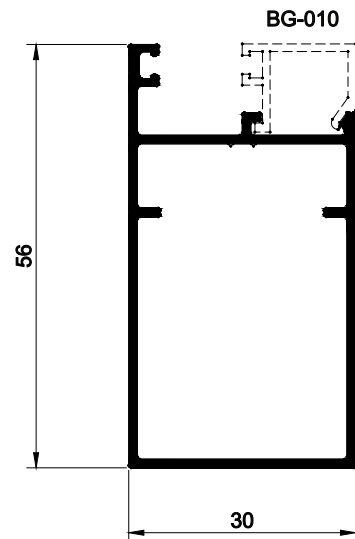

**E30-008**  
0,550 kg/m

## MARCO SUPERIOR 2 PLANOS / CORRER

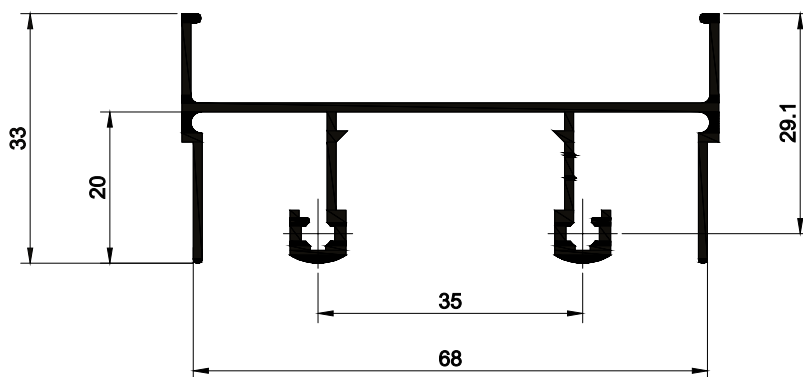
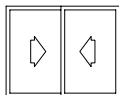

**E90-001**  
0,719 kg/m

## MARCO INFERIOR 2 PLANOS / CORRER

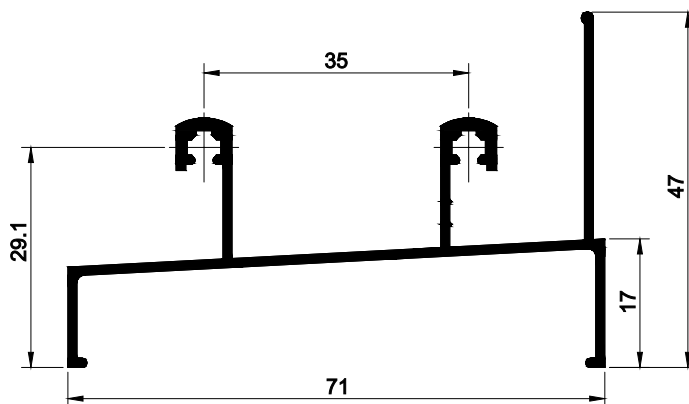
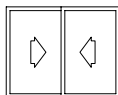

**E90-002**  
0,663 kg/m

## MARCO BANDEIRA E PEITORIL 2 PLANOS / CORRER

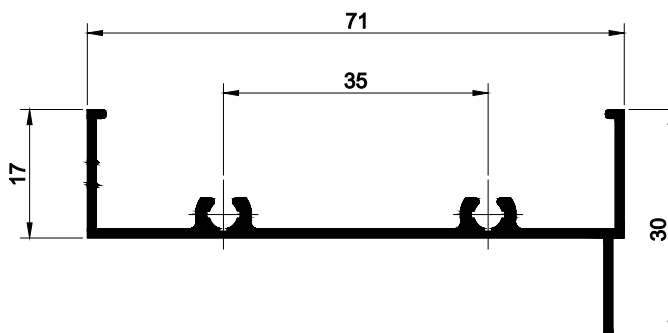
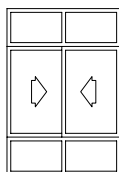

**E90-004**  
0,470 kg/m

## TRILHO SUPERIOR BANDEIRA E PEITORIL 2 PLANOS / CORRER

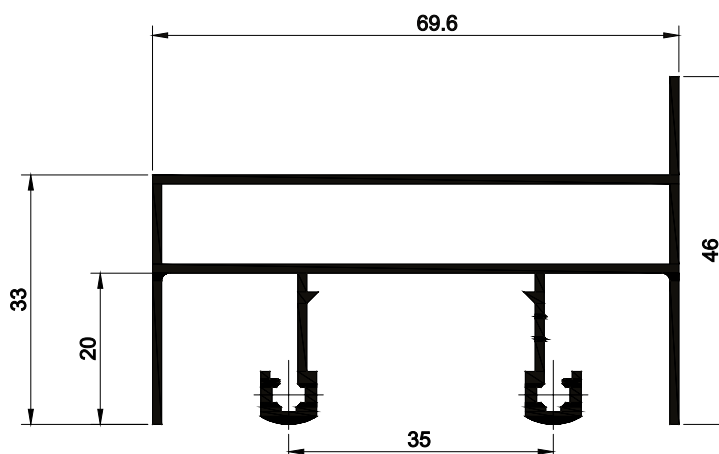
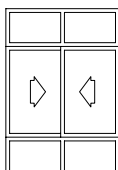

**E90-005**  
0,955 kg/m

## TRILHO INFERIOR BANDEIRA E PEITORIL 2 PLANOS / CORRER

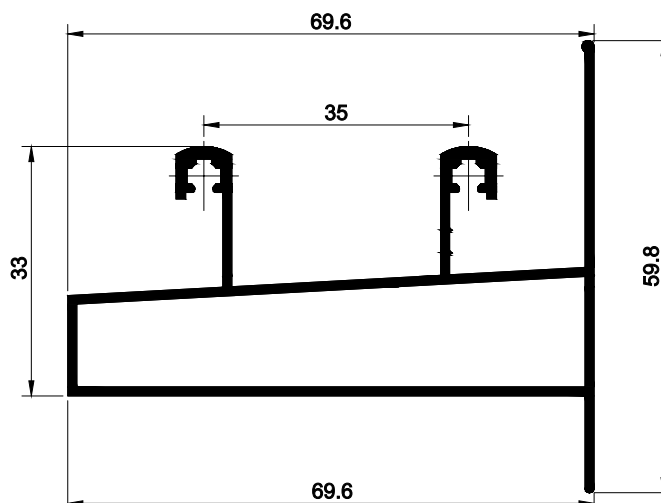
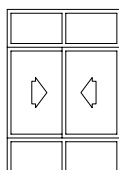

**E90-006**  
0,908 kg/m

**MARCO SUPERIOR 2 PLANOS / CORRER**

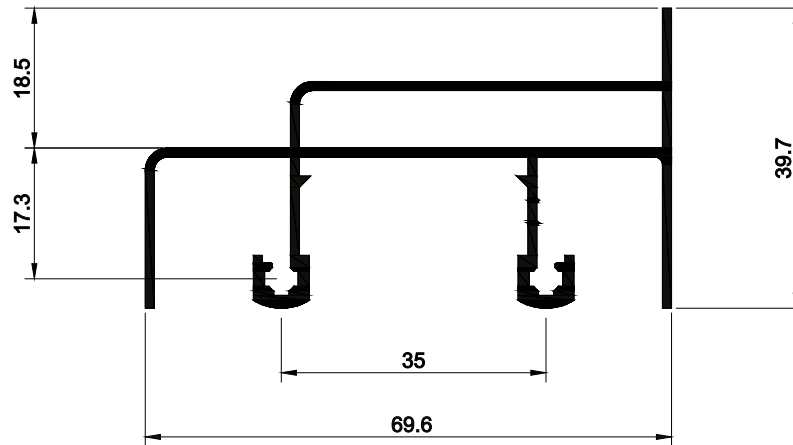
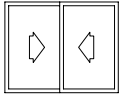

**E90-205**  
0,854 kg/m

**MARCO INFERIOR 2 PLANO / CORRER**

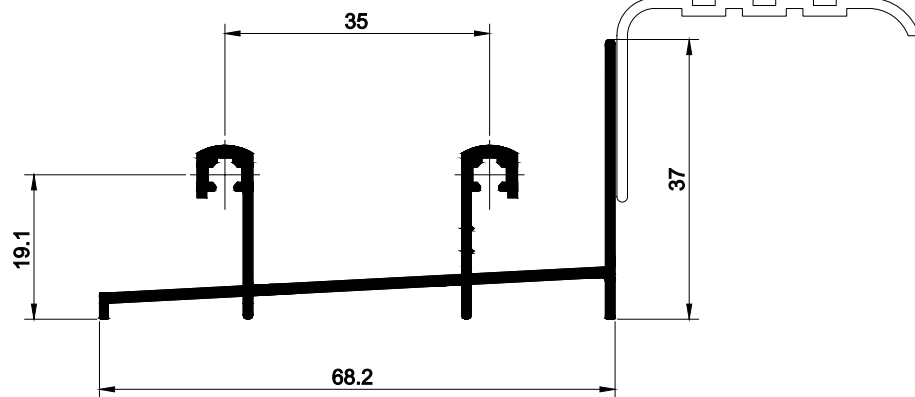
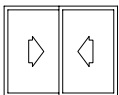

**E90-228**  
0,656 kg/m

**MARCO INFERIOR 2 PLANO / CORRER**

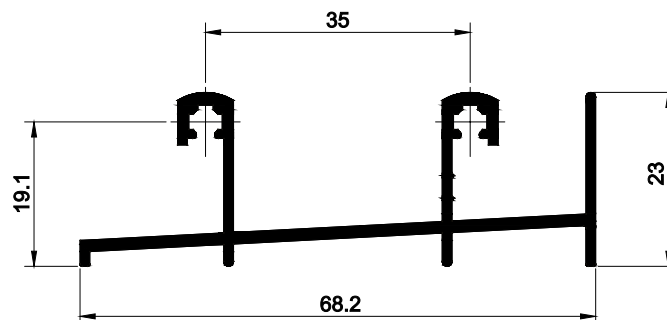
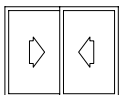

**E90-260**  
0,653 kg/m



**MARCO INFERIOR 2 PLANOS / CORRER**

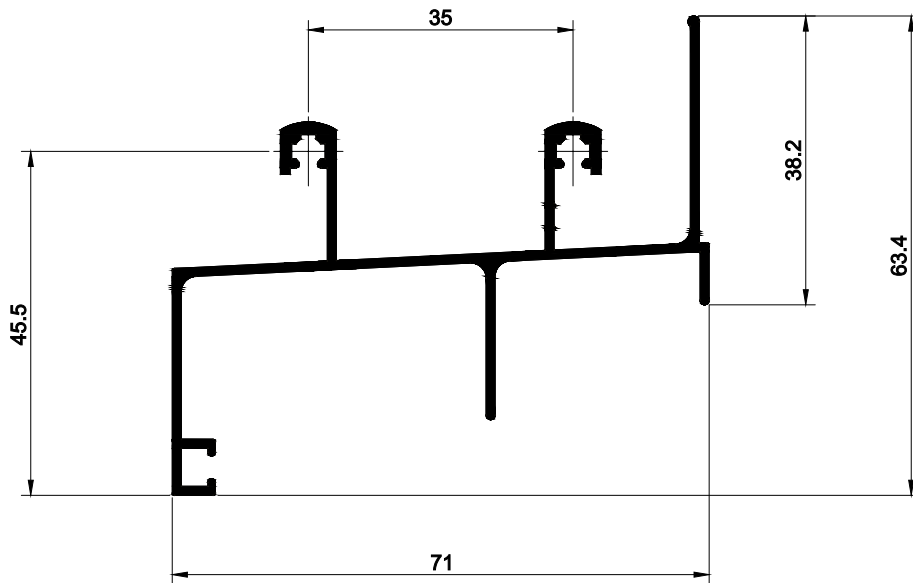
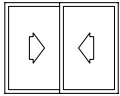

**E90-251**  
0,787 kg/m

**MARCO LATERAL COM MATA JUNTA**  
2 PLANOS / CORRER

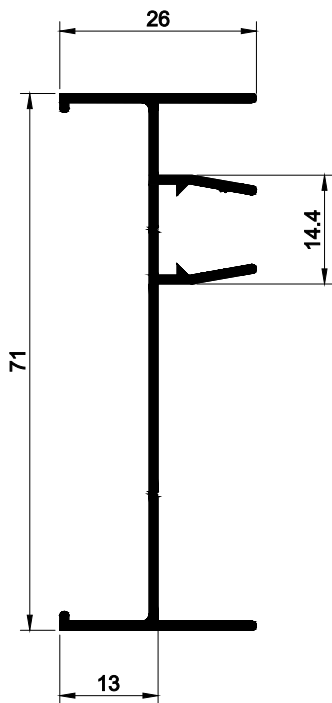
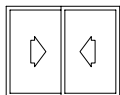

**E90-003**  
0,491 kg/m

**MARCO LATERAL SEM MATA JUNTA**  
2 PLANOS / CORRER

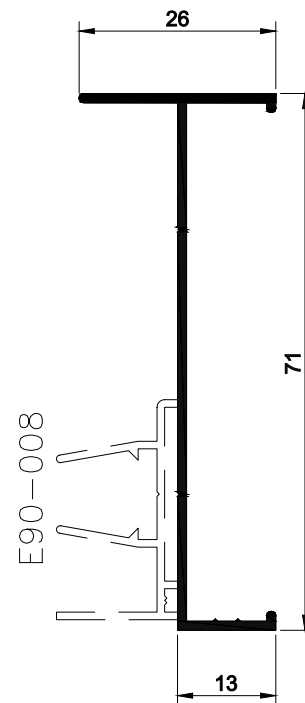
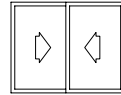

**E90-007**  
0,357 kg/m

**MARCO SUPERIOR 3 PLANOS BANDEIRA / CORRER**

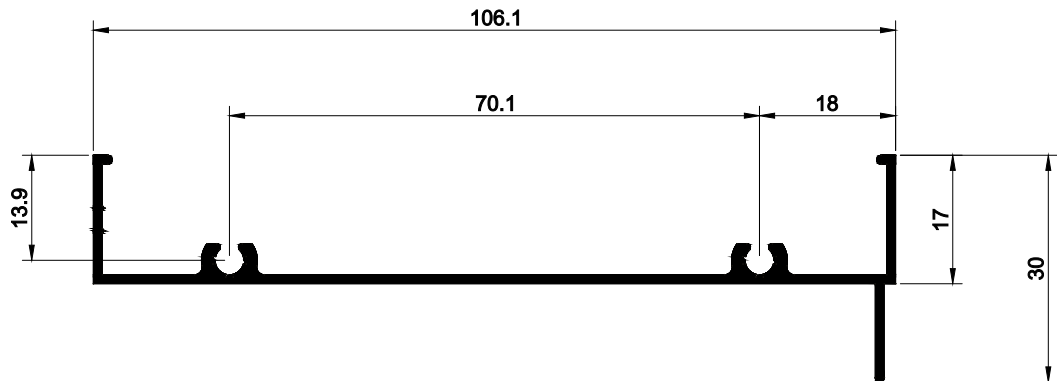
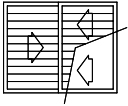

**E90-018**  
0,584 kg/m

**MARCO SUPERIOR 3 PLANOS BANDEIRA / CORRER**

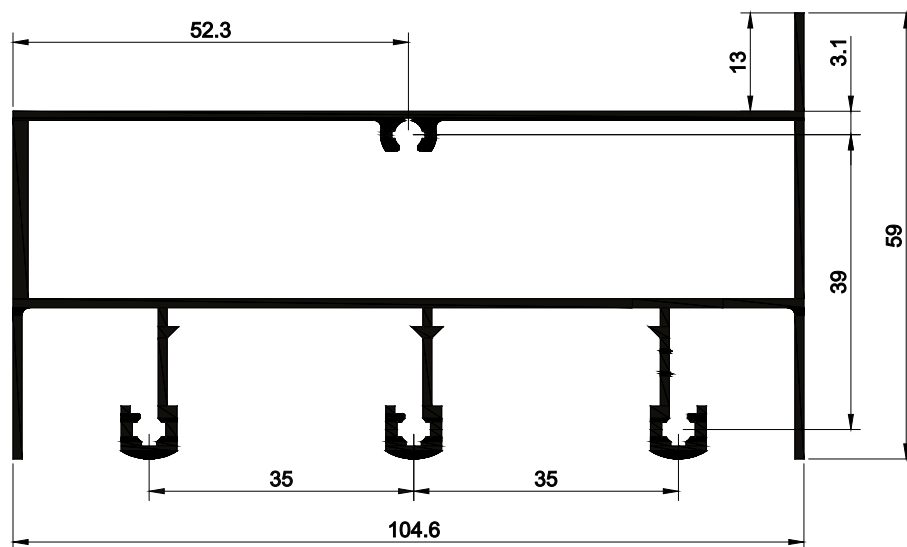
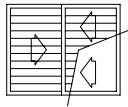

**E90-019**  
1,49 kg/m

**MARCO SUPERIOR 3 PLANOS / CORRER**

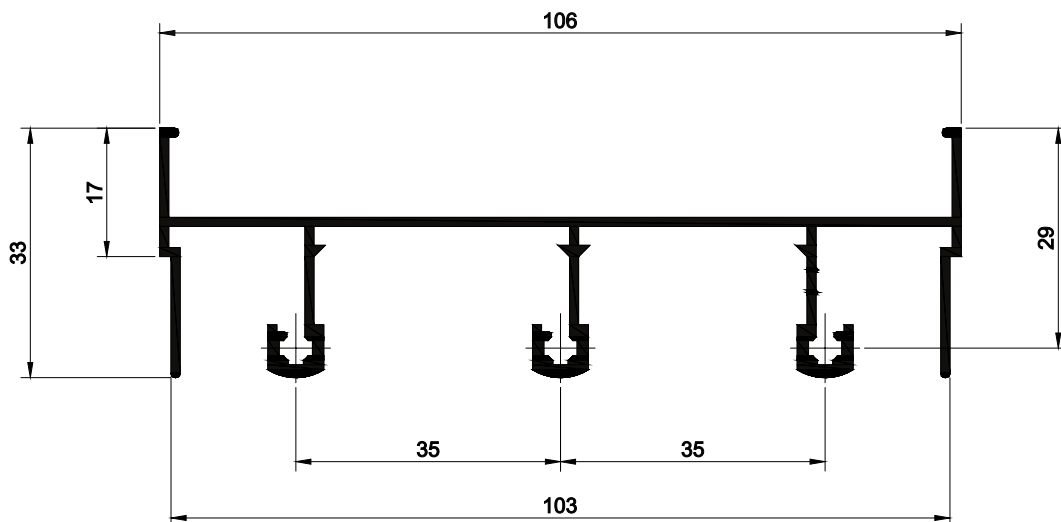
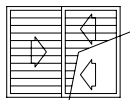

**E90-010**  
0,960 kg/m

**MARCO INFERIOR 3 PLANOS / CORRER**

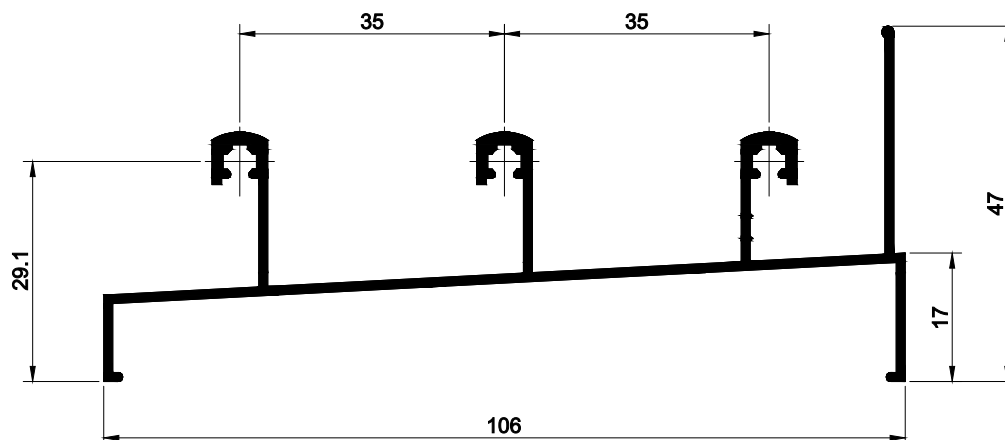
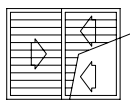

**E90-011**  
0,894 kg/m

**TRILHO INFERIOR BANDEIRA E PETTORIL 2 PLANOS / CORRER**

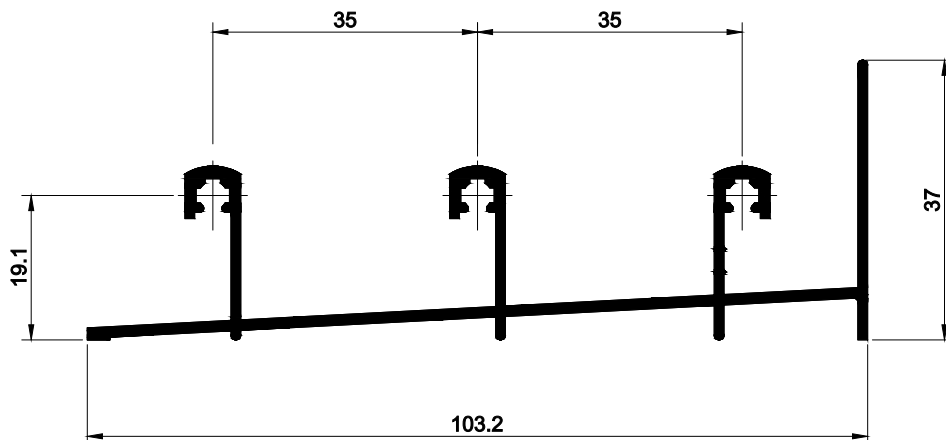
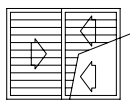

**E90-230**  
0,916 kg/m

## MARCO SUPERIOR 4 PLANOS / CORRER

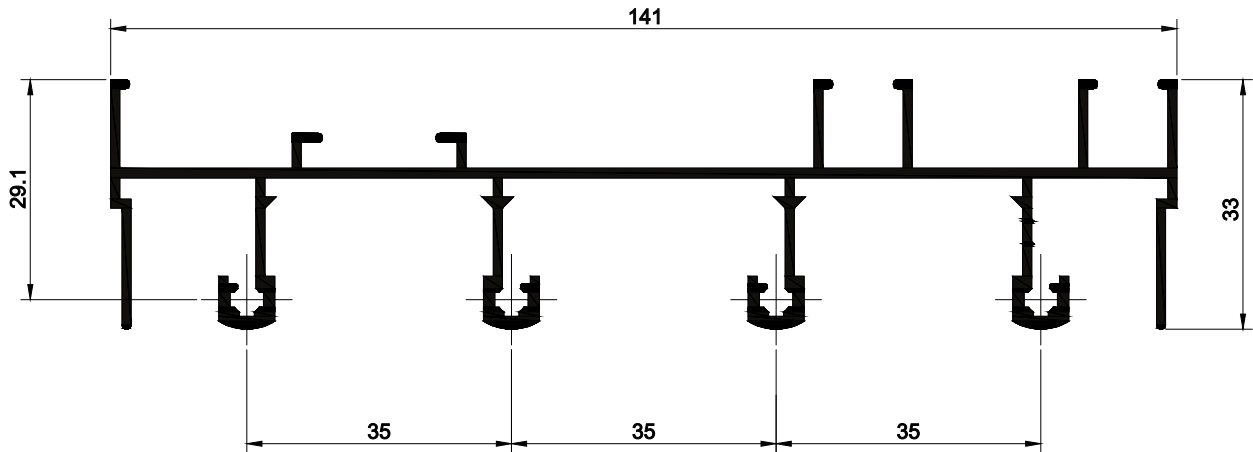
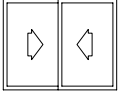

**E90-121**  
1,417 kg/m

## MARCO INFERIOR 4 PLANOS / CORRER

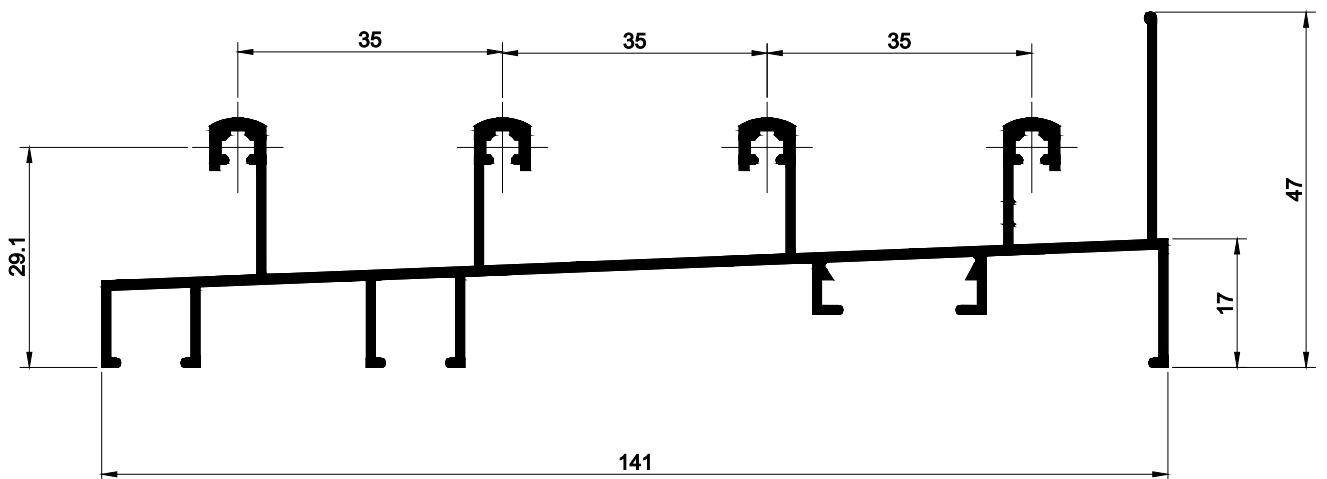
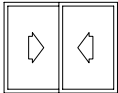

**E90-122**  
1,365 kg/m

**MARCO LATERAL COM MATA JUNTA DUPLA  
3 PLANOS / CORRER**

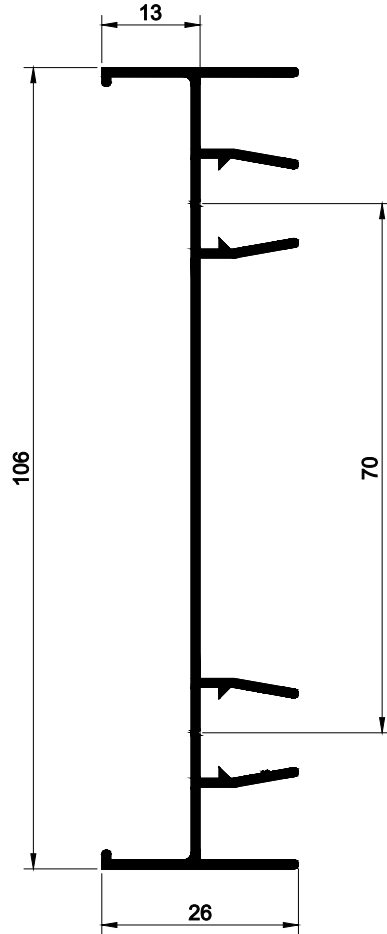
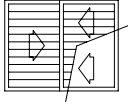

**E90-013**  
0,695 kg/m

**MARCO LATERAL SEM MATA JUNTA  
3 PLANOS / CORRER**

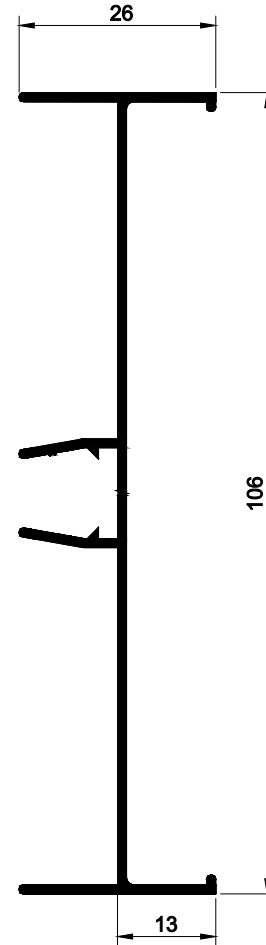
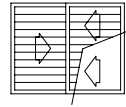

**E90-014**  
0,605 kg/m

**MARCO LATERAL SEM MATA JUNTA**

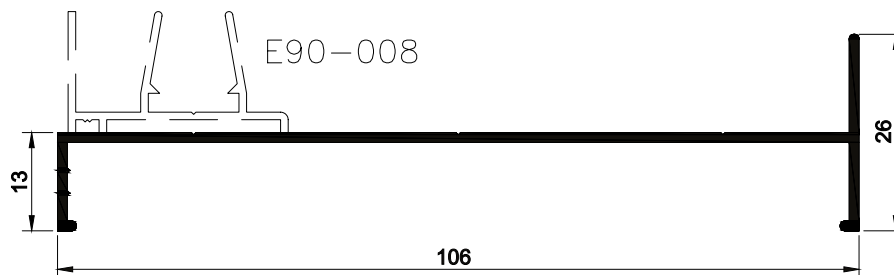
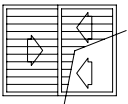

**E90-012**  
0,609 kg/m

**MARCO INFERIOR 4 PLANOS / CORRER**

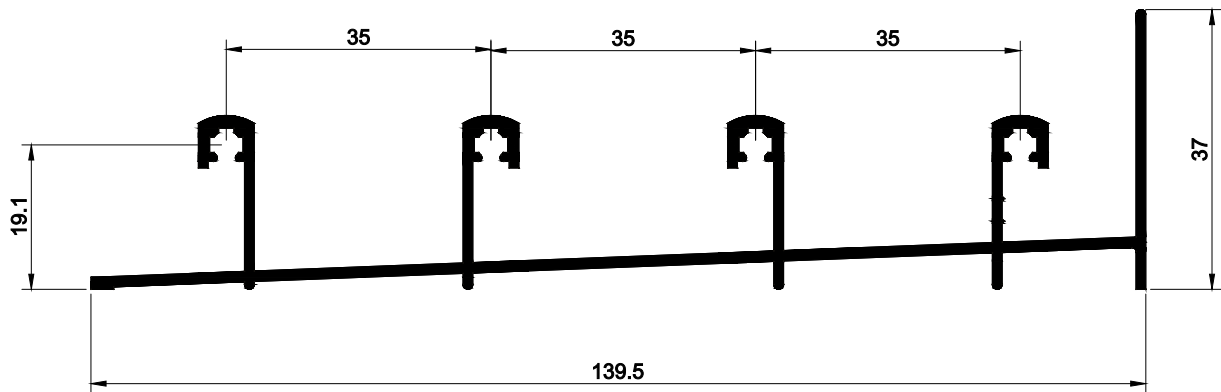
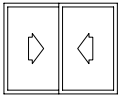

**E90-222**  
1,178kg/m

**TRILHO INFERIOR 2 PLANOS INTEGRADA / CORRER**

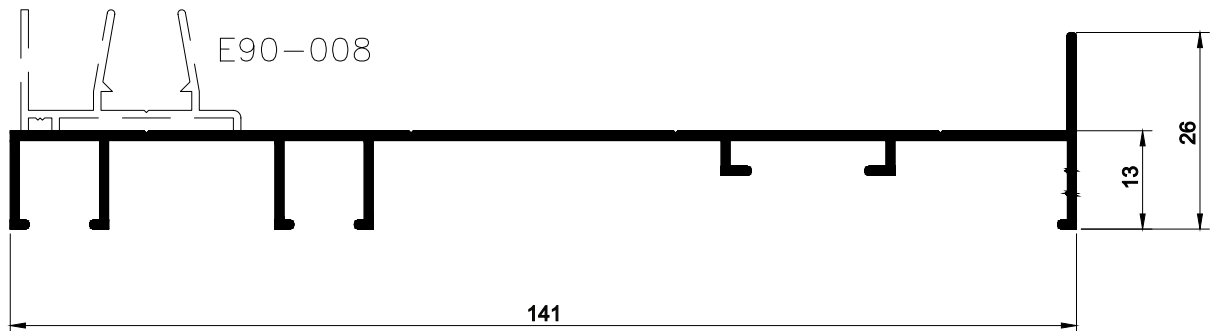
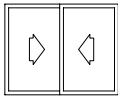

**E90-123**  
0,800kg/m

<p><b>MONTANTE LATERAL / CORRER</b></p> <p><b>E90-039</b> 0,475 kg/m</p>	<p><b>MONTANTE LATERAL FEC CENTRAL / CORRER</b></p> <p><b>E90-192</b> 0,475 kg/m</p>
<p><b>MONTANTE LATERAL / CORRER</b></p> <p><b>E90-245</b> 0,635 kg/m</p>	<p><b>MONTANTE LATERAL / CORRER</b></p> <p><b>E90-601</b> 0,548 kg/m</p>
<p><b>MONTANTE LATERAL COM REFORÇO / CORRER</b></p> <p><b>E90-044</b> 0,972 kg/m</p>	<p><b>MONTANTE LATERAL / CORRER</b></p> <p><b>E90-043</b> 0,976 kg/m</p>

**MONTANTE MÃO DE AMIGO / CORRER**

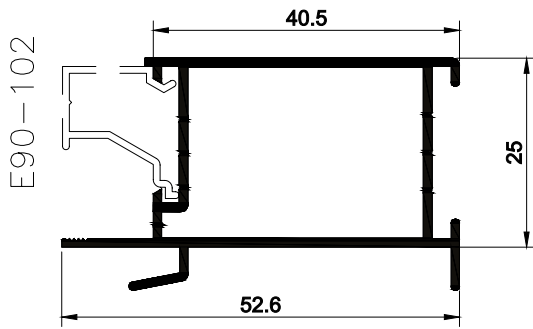

**E90-282**  
0,526kg/m

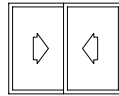

**MONTANTE MÃO DE AMIGO / CORRER**

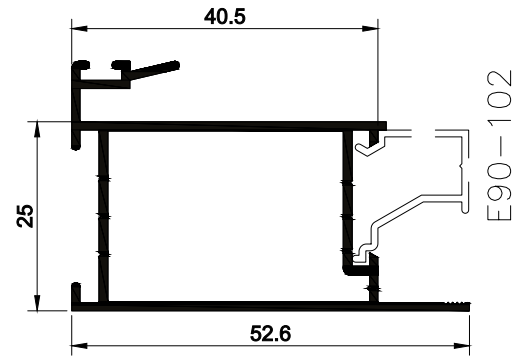

**E90-283**  
0,550 kg/m

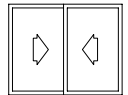

**MONTANTE MÃO DE AMIGO / CORRER**

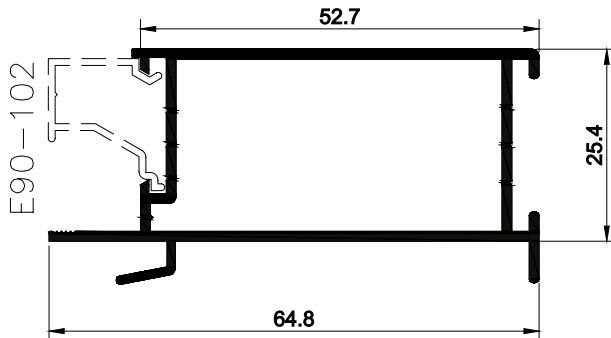

**E90-243**  
0,663 kg/m

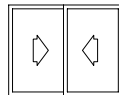

**MONTANTE MÃO DE AMIGO / CORRER**

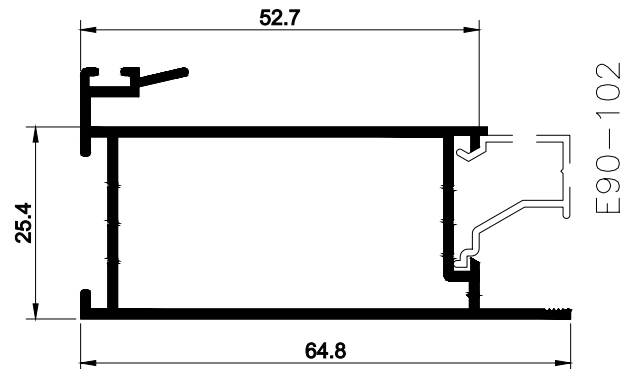

**E90-242**  
0,693 kg/m

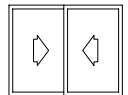

**MONTANTE MÃO DE AMIGO REF / CORRER**

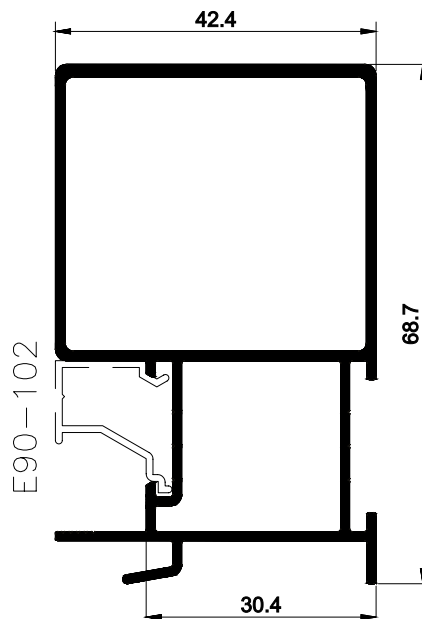
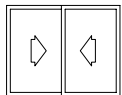

**E90-047**  
0,974 kg/m

**TRAVESSA / CORRER**

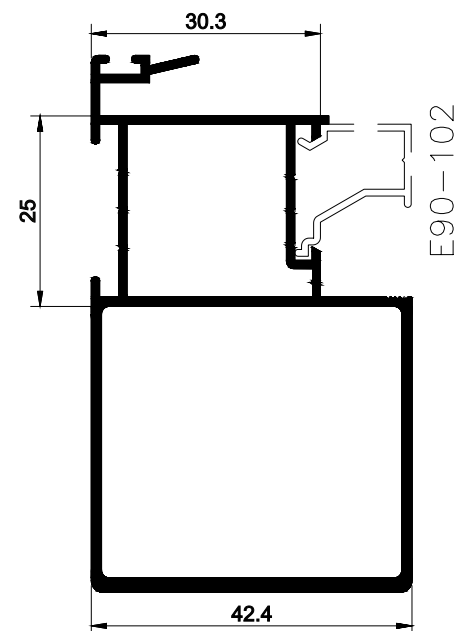
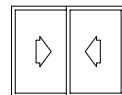

**E90-049**  
0,970 kg/m



**MONTANTE LATERAL / CORRER**

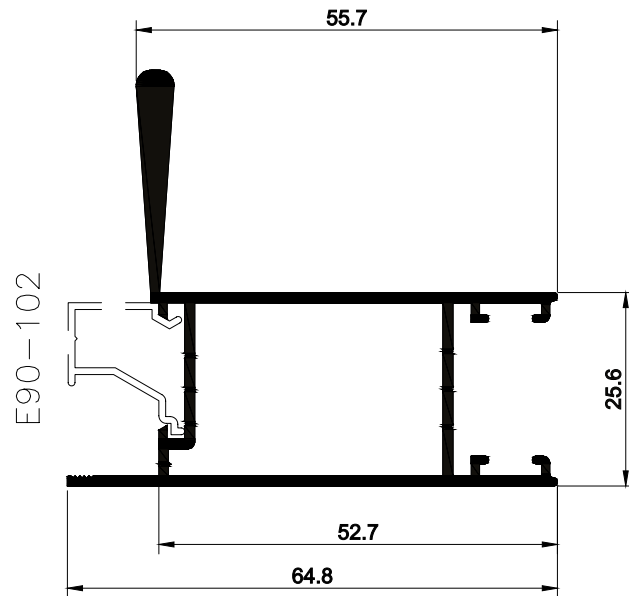
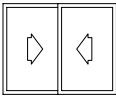

**E90-280**  
0,912 kg/m

**MONTANTE LATERAL / CORRER**

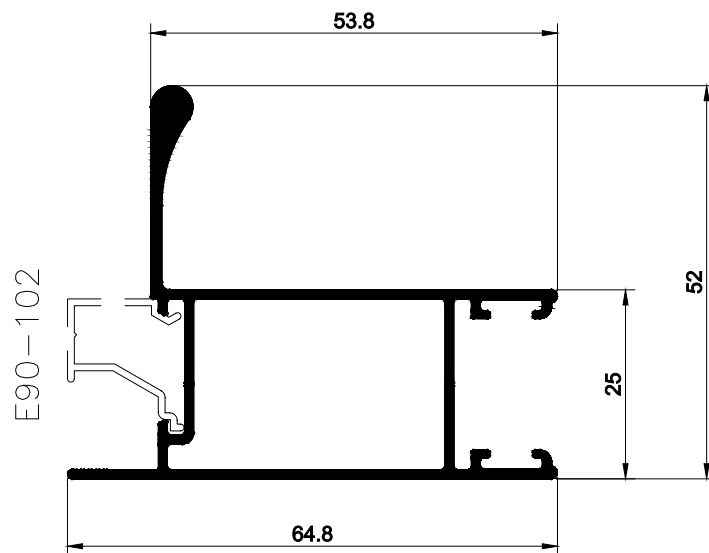
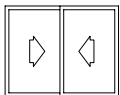

**E90-609**  
0,789 kg/m

**MONTANTE MÃO DE AMIGO / CORRER**

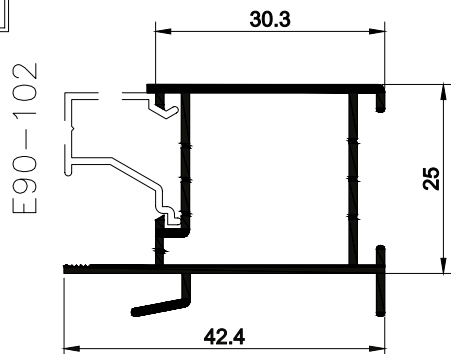
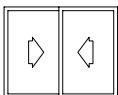

**E90-040**  
0,435 kg/m

**MONTANTE MÃO DE AMIGO / CORRER**

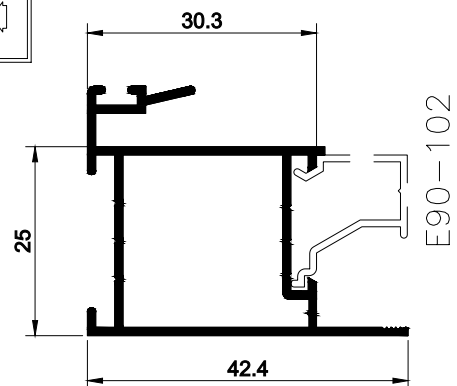
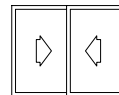

**E90-041**  
0,463 kg/m

**TRAVESSA / CORRER**

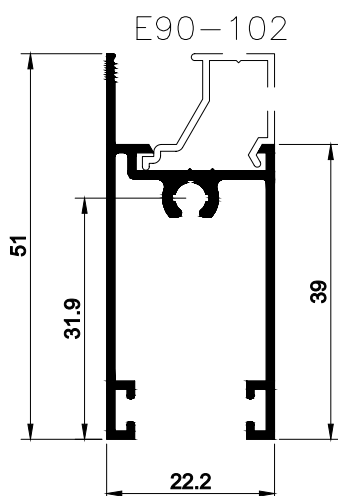
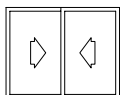

**E90-053**  
0,439 kg/m

**TRAVESSA CENTRAL / CORRER**

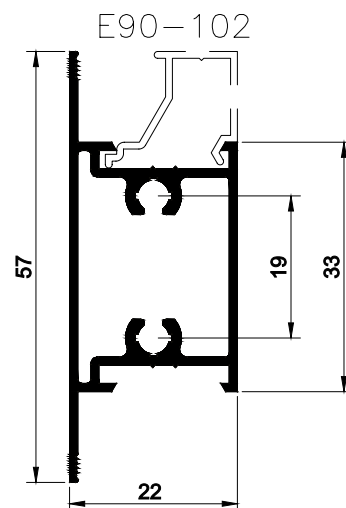
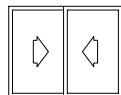

**E90-227**  
0,525 kg/m

**TRAVESSA / CORRER**

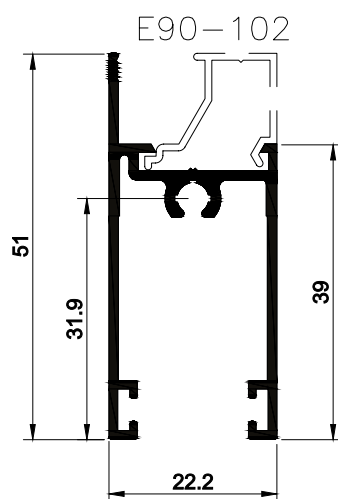
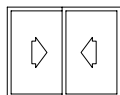

**E90-153**  
0,484 kg/m

**TRAVESSA / CORRER**

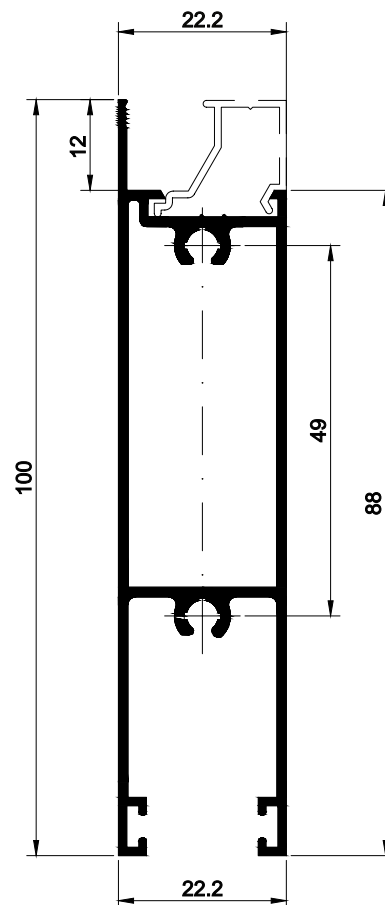
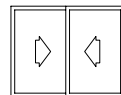

**E90-225**  
0,941 kg/m

**MONTANTE MÃO DE AMIGO / CORRER**

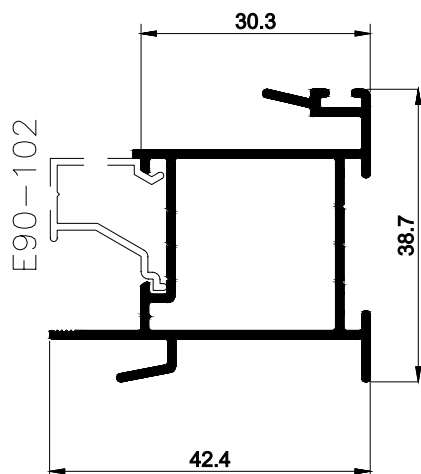
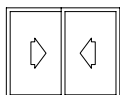

**E90-042**  
0,514 kg/m

MONTANTE LATERAL SEM BAGUETE / CORRER

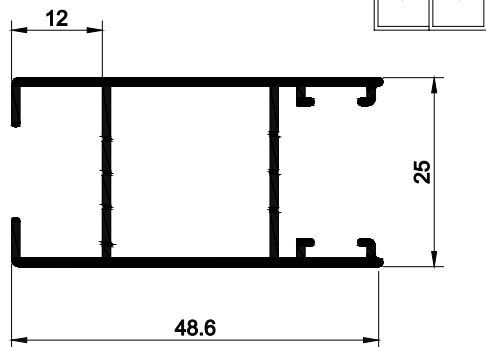

**E90-055**  
0,499 kg/m

MONTANTE LATERAL SEM BAGUETE / CORRER

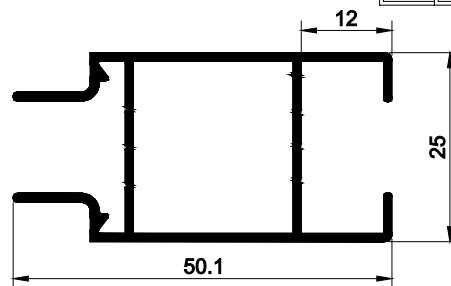

**E90-190**  
0,506 kg/m

MONTANTE LATERAL SEM BAGUETE / CORRER

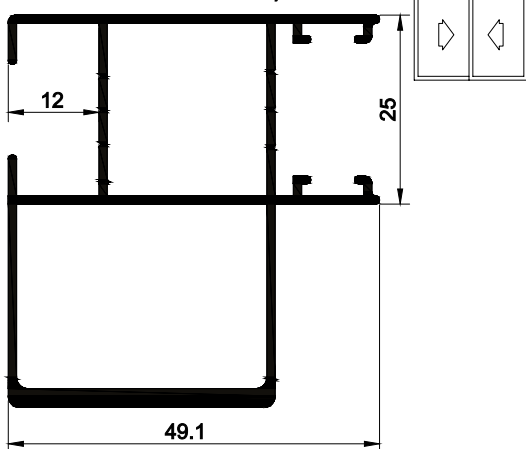

**E90-060**  
0,883 kg/m

MONTANTE LATERAL SEM BAGUETE / CORRER

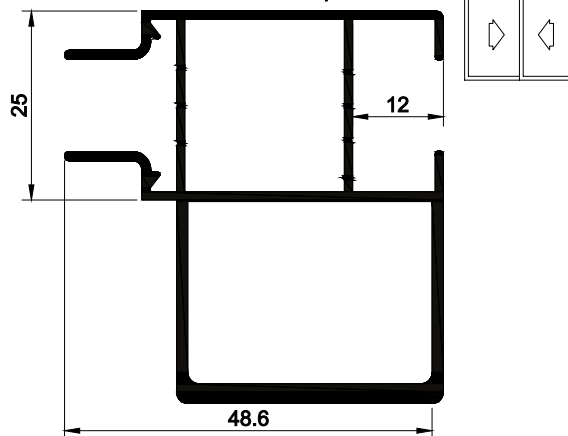

**E90-059**  
0,969 kg/m

MONTANTE LATERAL SEM BAGUETE / CORRER

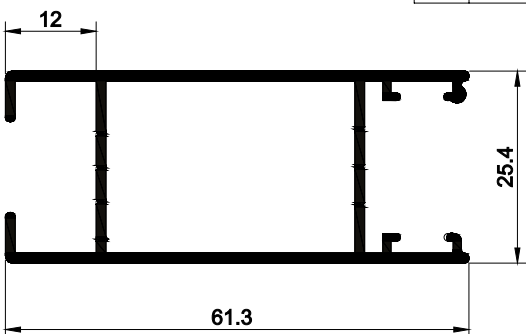

**E90-238**  
0,669 kg/m

MONTANTE LATERAL SEM BAGUETE / CORRER

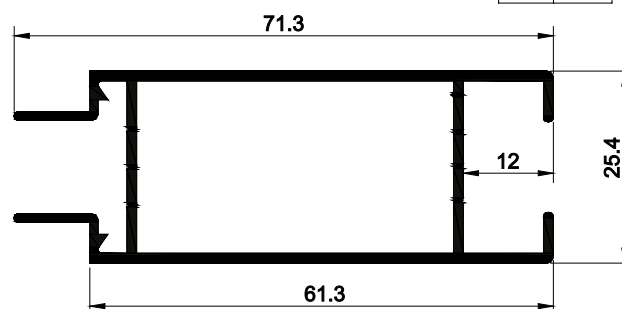

**E90-240**  
0,669 kg/m

**MONTANTE MÃO DE AMIGO SEM BAGUETE / CORRER**

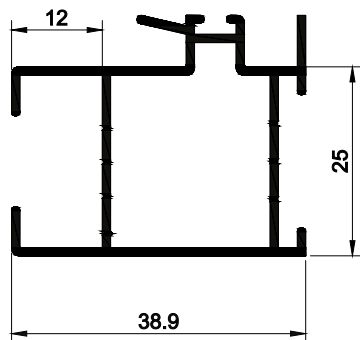
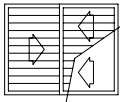

**E90-056**  
0,496 kg/m

**MONTANTE MÃO DE AMIGO SEM BAGUETE REF / CORRER**

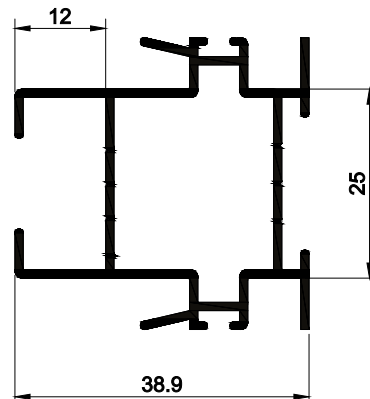
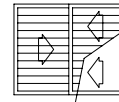

**E90-057**  
0,582 kg/m

**MONTANTE MÃO DE AMIGO SEM BAGUETE / CORRER**

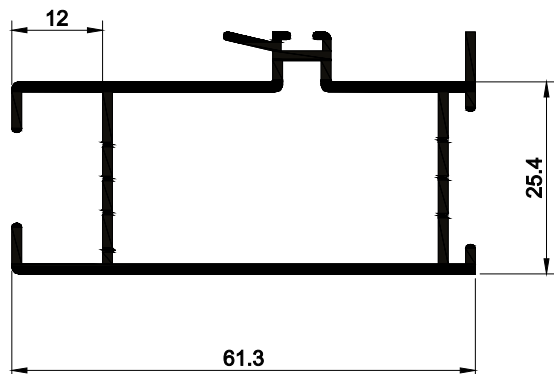
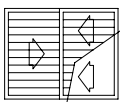

**E90-239**  
0,734 kg/m

**MONTANTE MÃO DE AMIGO SEM BAGUETE REF / CORRER**

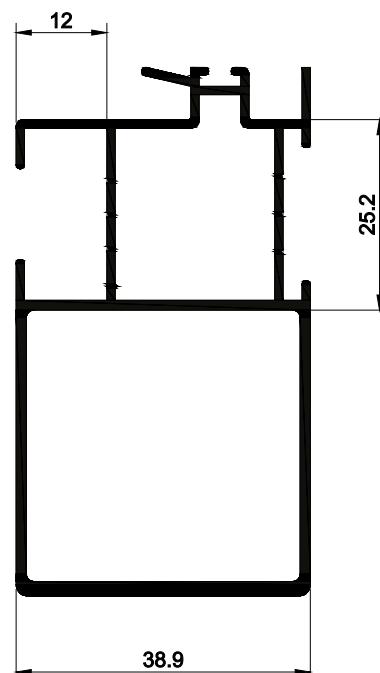
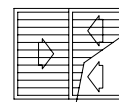

**E90-061**  
0,981 kg/m

TRAVESSA SEM BAGUETE / CORRER

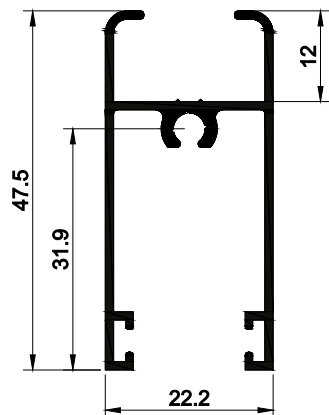
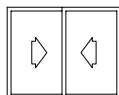

**E90-186**  
0,484 kg/m

TRAVESSA SEM BAGUETE / CORRER

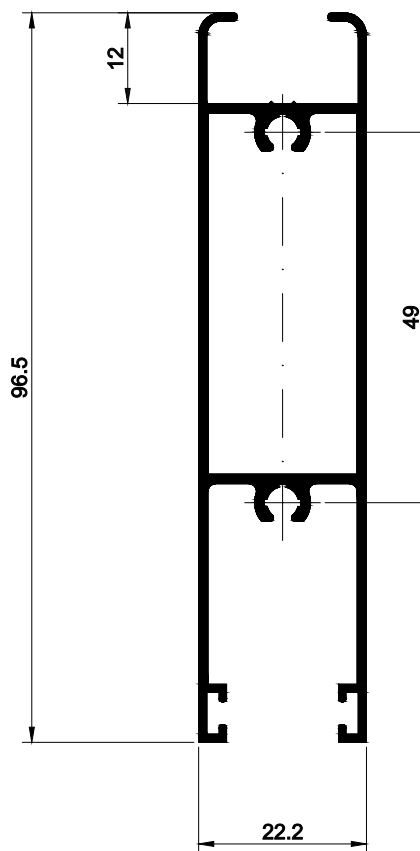
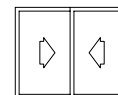

**E90-226**  
0,954 kg/m

TRAVESSA CENTRAL SEM BAGUETE / CORRER

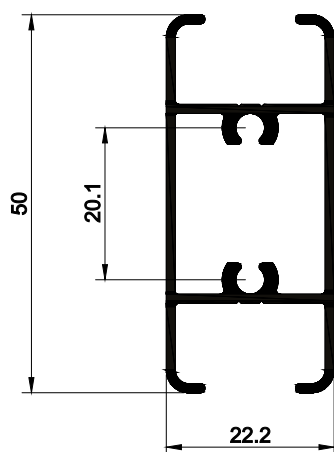
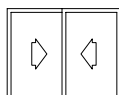

**E90-188**  
0,579 kg/m

TAMPA EXTERNA PORTA / INTEGRADA

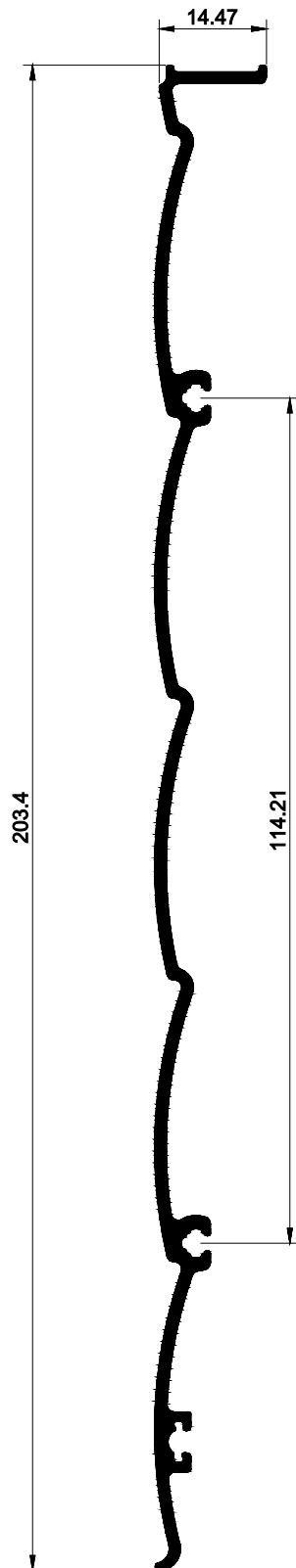

**E90-607**  
1,106 kg/m

TAMPA INTERNA JANELA / INTEGRADA

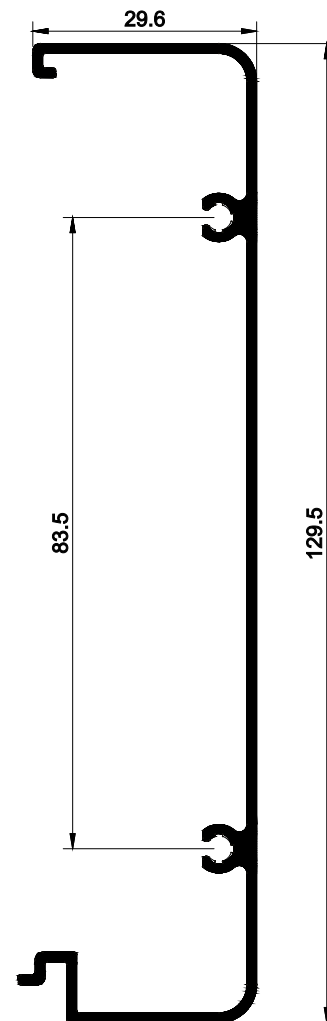
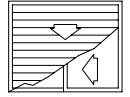

**E90-608**  
0,818 kg/m

**MONTANTE LATERAL / CORRER**

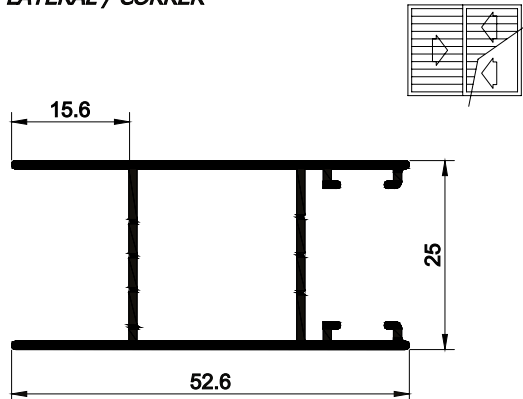

**E90-068**  
0,489 kg/m

**MONTANTE LATERAL / CORRER**

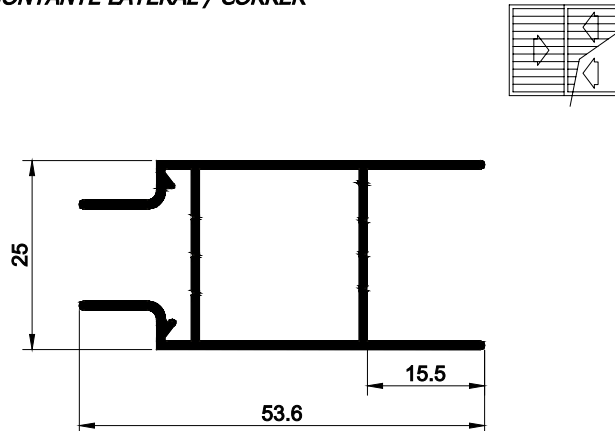

**E90-191**  
0,496 kg/m

**MONTANTE MÃO DE AMIGO / CORRER**

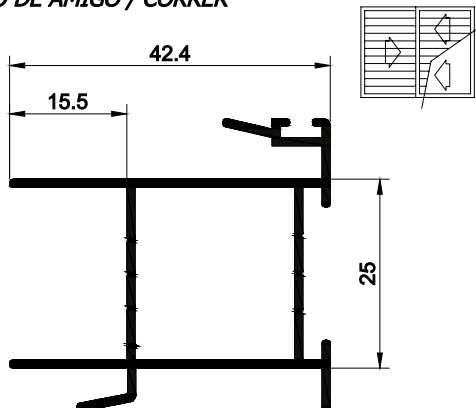

**E90-069**  
0,525 kg/m

**MONTANTE MÃO DE AMIGO / CORRER**

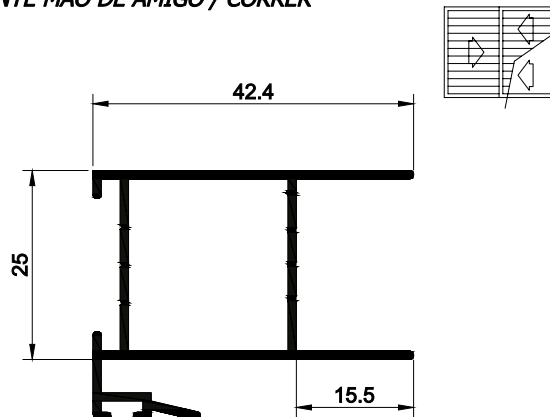

**E90-070**  
0,480 kg/m

**MONTANTE LATERAL / CORRER**

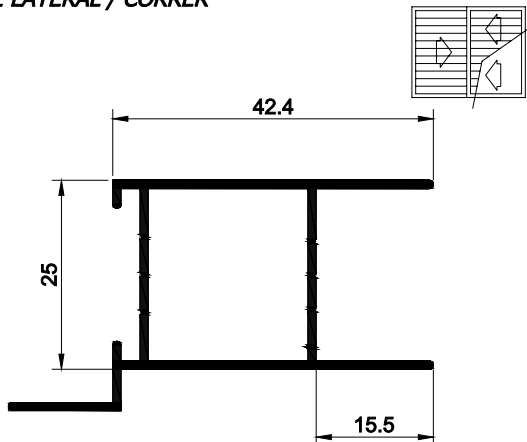

**E90-074**  
0,458 kg/m

**TRAVESSA / CORRER**

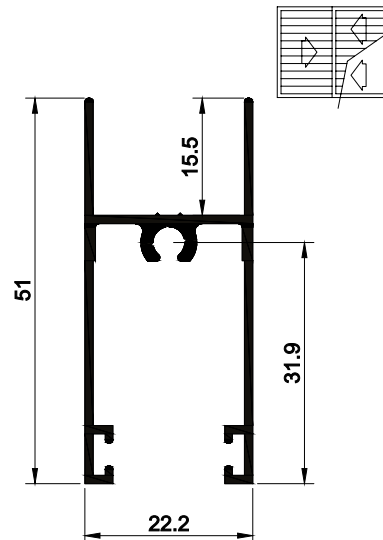

**E90-187**  
0,466 kg/m

MARCO / GIRO

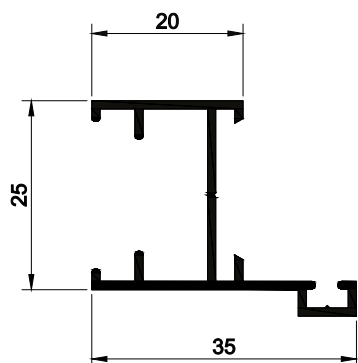
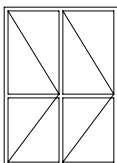

**E90-079**  
0,305 kg/m

MONTANTE FOLHA SEM BAGUETE / GIRO

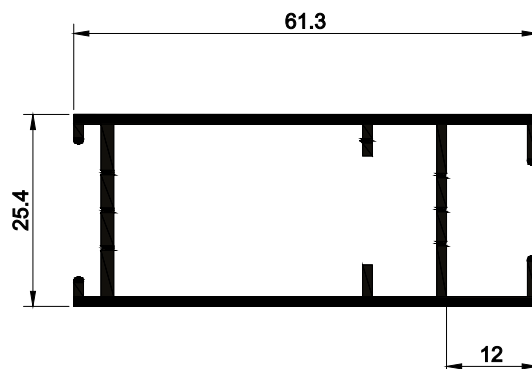
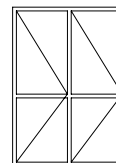

**E90-241**  
0,699 kg/m

MONTANTE FOLHA / GIRO

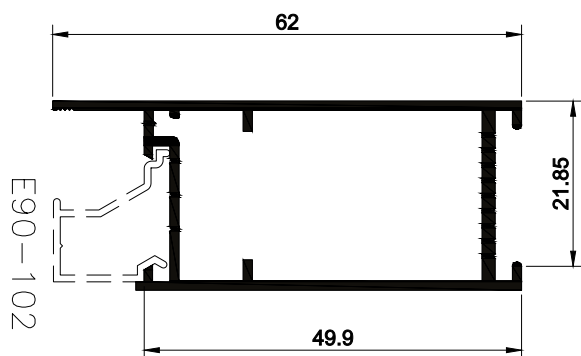
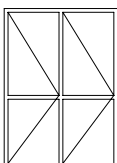

**E90-111**  
0,597 kg/m

MONTANTE FOLHA / GIRO

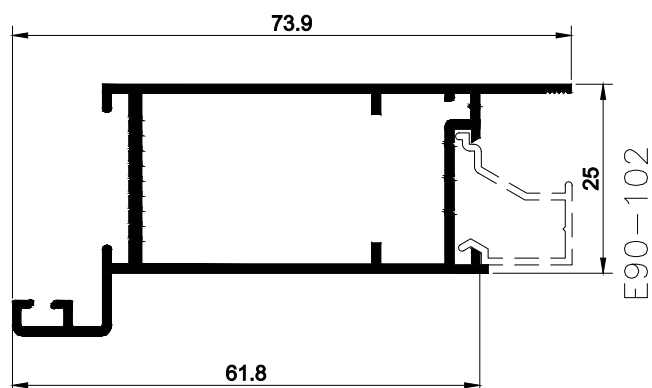
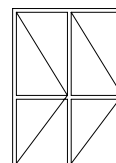

**E90-113**  
0,688 kg/m



TRAVESSA CENTRAL / CORRER E GIRO

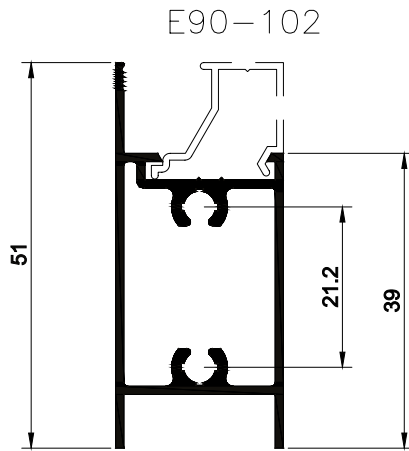
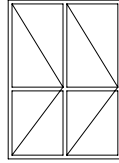

**E90-110**  
0,507 kg/m

TRAVESSA CENTRAL / CORRER E GIRO

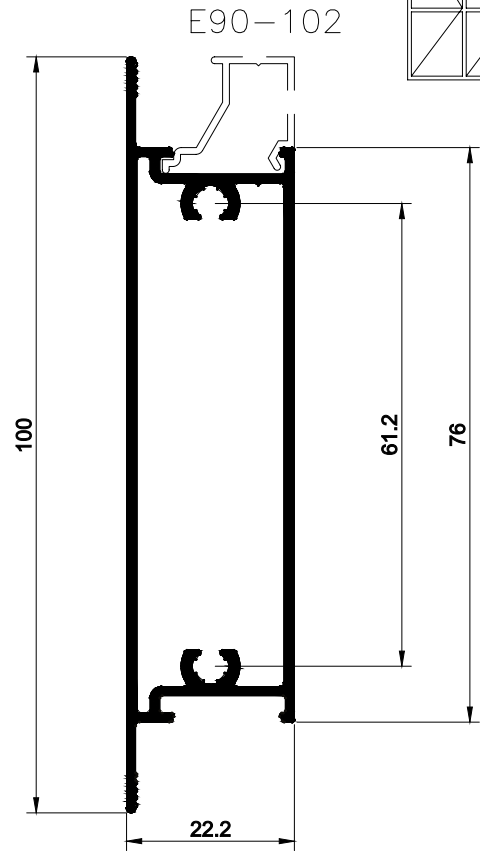
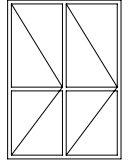

**E90-050**  
0,920 kg/m

MARCO / MAXIM-AR

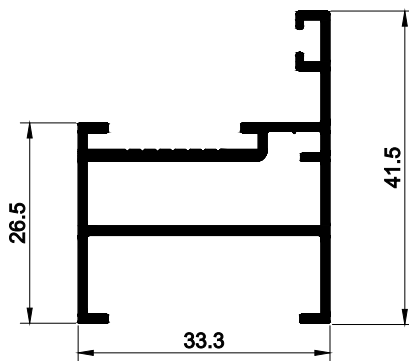

**E90-279**  
0,634 kg/m

TRAVESSA SUPERIOR / MAXIM-AR

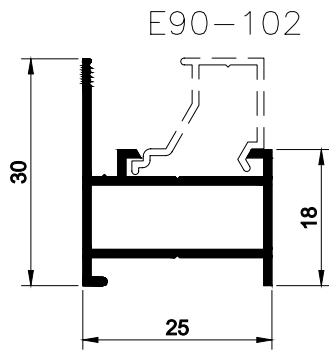

**E90-580**  
0,304 kg/m

TRAVESSA / MAXIM-AR

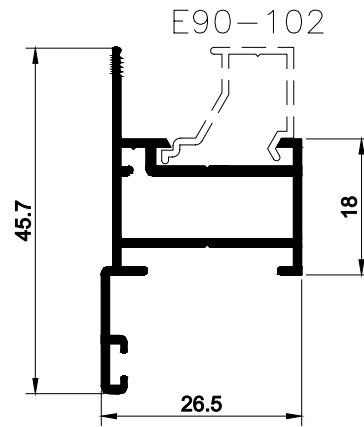

**E90-600**  
0,397 kg/m

TRAVESSA / MAXIM-AR

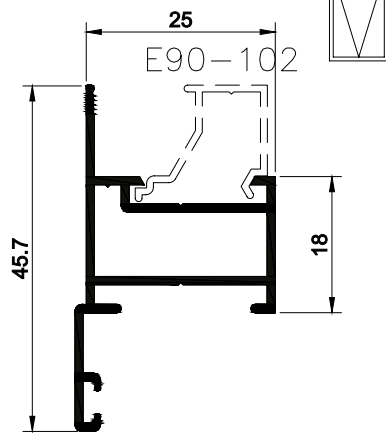

**E90-200**  
0,381 kg/m

TRAVESSA / MAXIM-AR

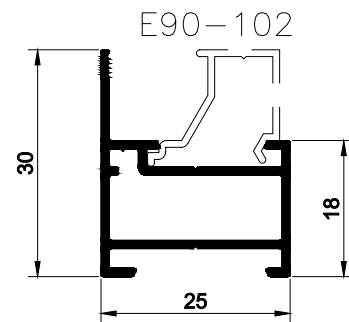

**E90-080**  
0,318 kg/m

TRAVESSA / MAXIM-AR

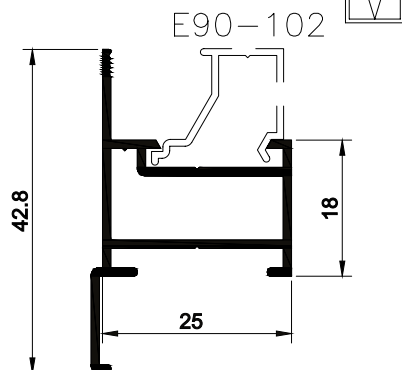

**E90-081**  
0,360 kg/m

TRAVESSA SEM BAGUETE / MAXIM-AR

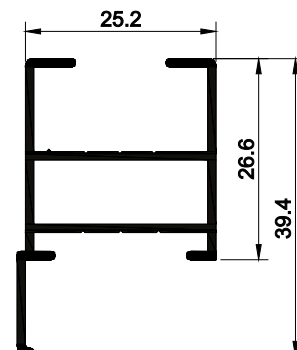

**E90-090**  
0,384 kg/m

<p><b>PINGADEIRA / MAXIM-AR</b></p> <p><b>E90-083</b> 0,139 kg/m</p>	<p><b>PINGADEIRA / MAXIM-AR</b></p> <p><b>E90-276</b> 0,165 kg/m</p>
<p><b>BAGUETE</b></p> <p><b>E90-102</b> 0,125 kg/m</p>	<p><b>BAGUETE</b></p> <p><b>E90-103</b> 0,138 kg/m</p>
<p><b>MATA JUNTA POSTIÇO MARCO / CORRER</b></p> <p><b>E90-008</b> 0,206 kg/m</p>	<p><b>BAGUETE ADAPTADOR VENEZIANA</b></p> <p><b>E90-108</b> 0,138 kg/m</p>
<p><b>MATA JUNTA POSTIÇO FOLHA / CORRER</b></p> <p><b>E90-291</b> 0,491 kg/m</p>	<p><b>BAGUETE</b></p> <p><b>E90-102R</b> 0,104 kg/m</p>

TRAVESSA SUPERIOR SEM BAGUETE / MAXIM-AR

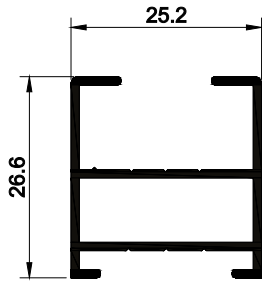

**E90-091**  
0,341 kg/m

TRAVESSA / MAXIM-AR

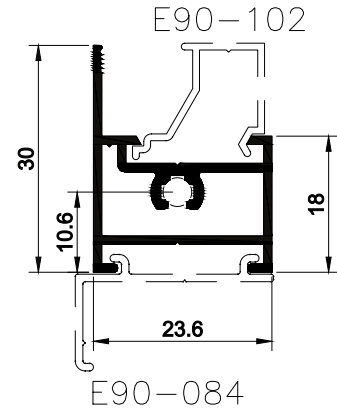

**E90-082**  
0,345 kg/m

TRAVESSA / MAXIM-AR

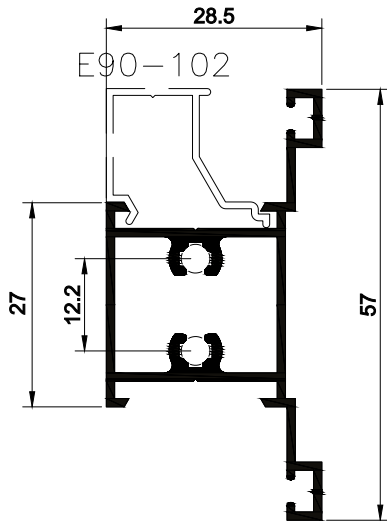
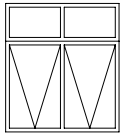

**E90-086**  
0,563 kg/m

TRAVESSA / MAXIM-AR

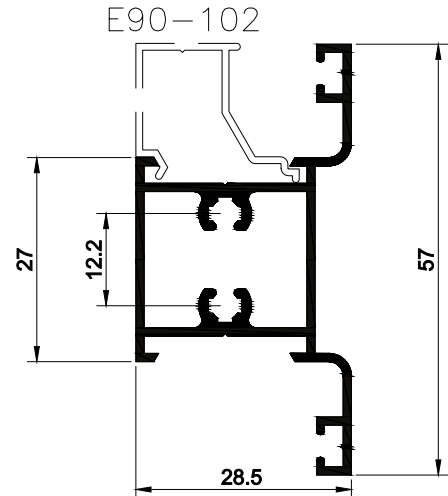
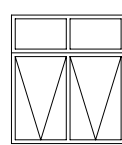

**E90-586**  
0,577 kg/m

COLUNA / MAXIM-AR

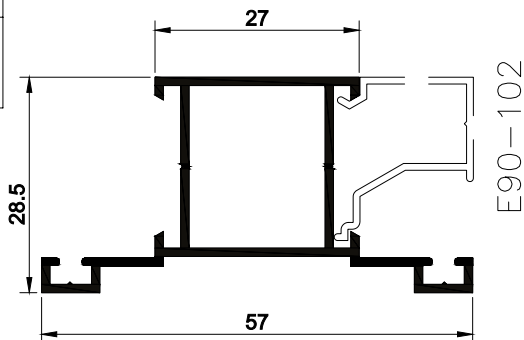
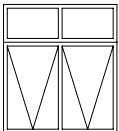

**E90-085**  
0,461 kg/m

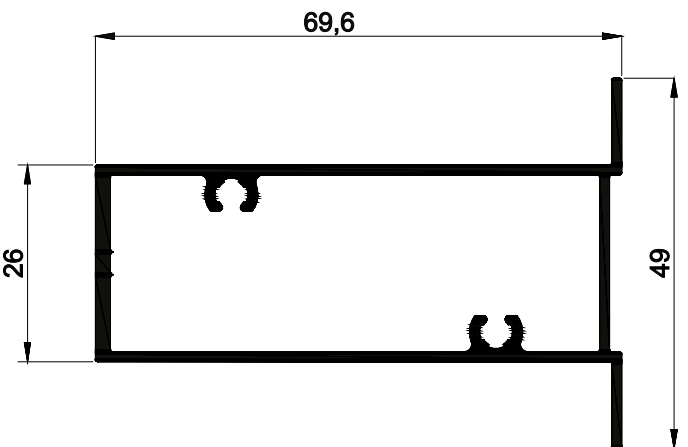

**E90-009**  
0,867 kg/m

**MARCO SUPERIOR 30 / CORRER**

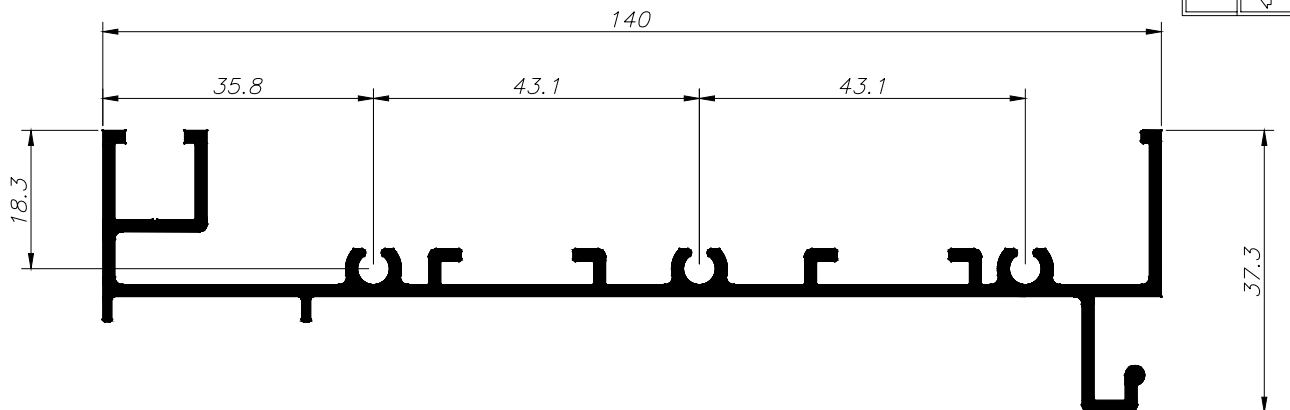

**EMN-001**  
1,314 kg/m

**MARCO LATERAL 30 / CORRER**

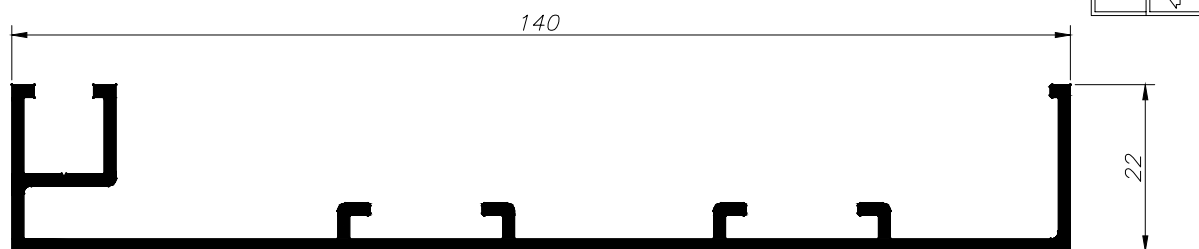

**EMN-003**  
1,030 kg/m

**TRILHO 2 FOLHAS / CORRER**

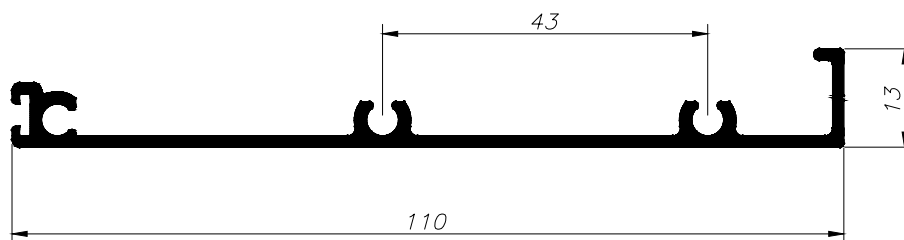

**EMN-002**  
0,669 kg/m

TAMPA EXTERNA PORTA / CORRER

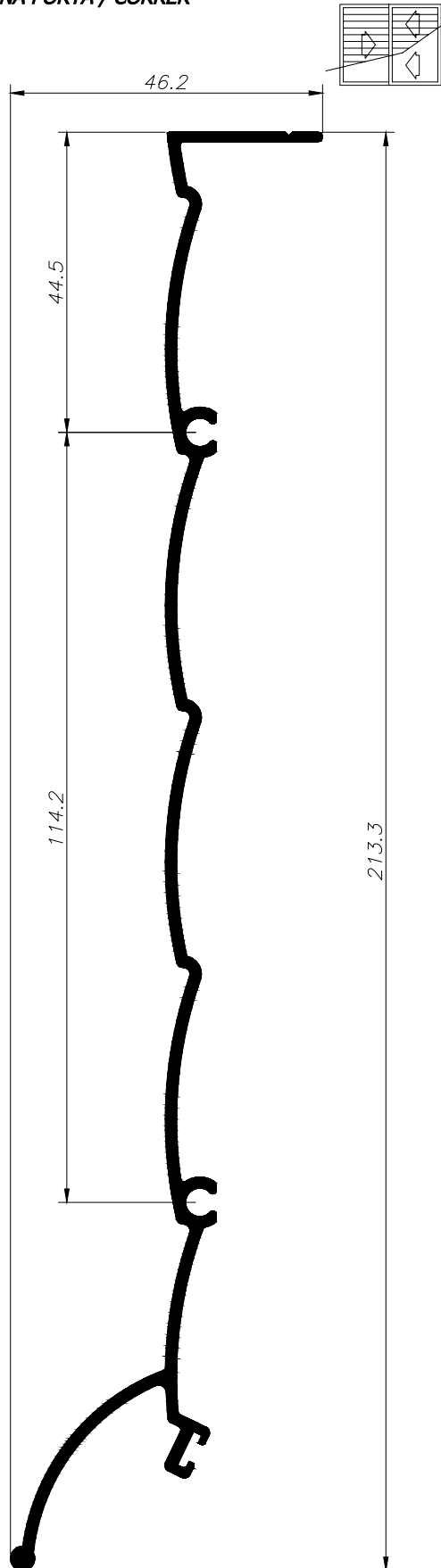

**EMN-039**  
1,333 kg/m

TAMPA INTERNA JANELA / CORRER

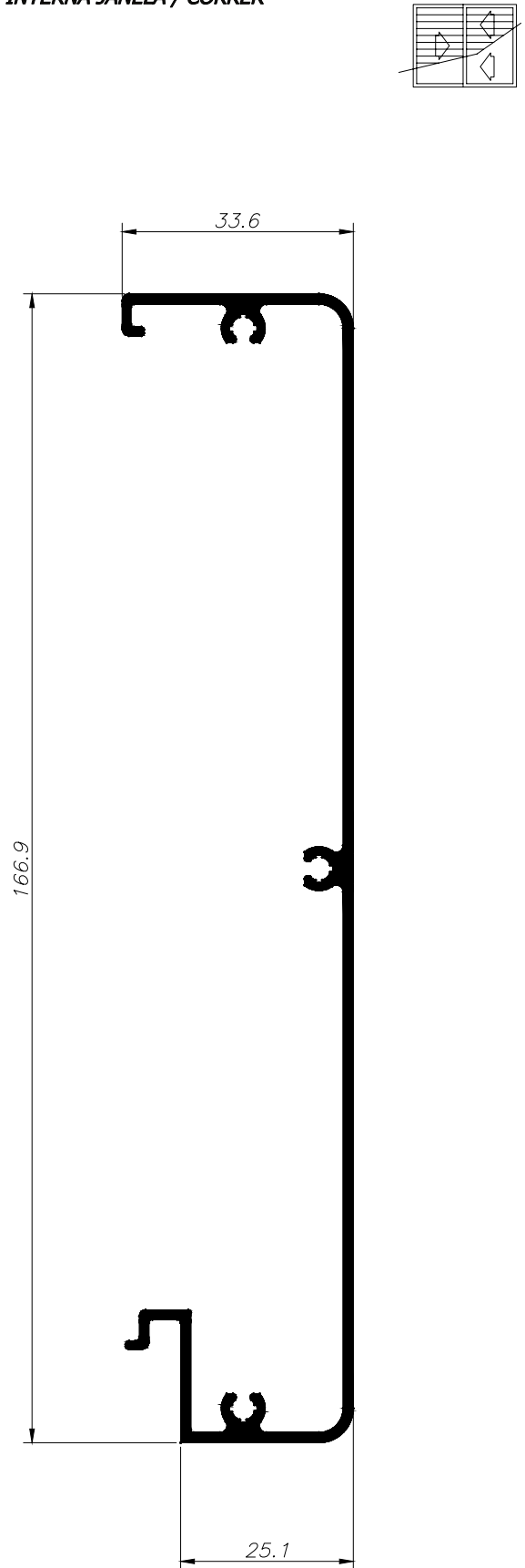

**EMN-031**  
1,198 kg/m

**TRILHO 2 FOLHAS / CORRER**

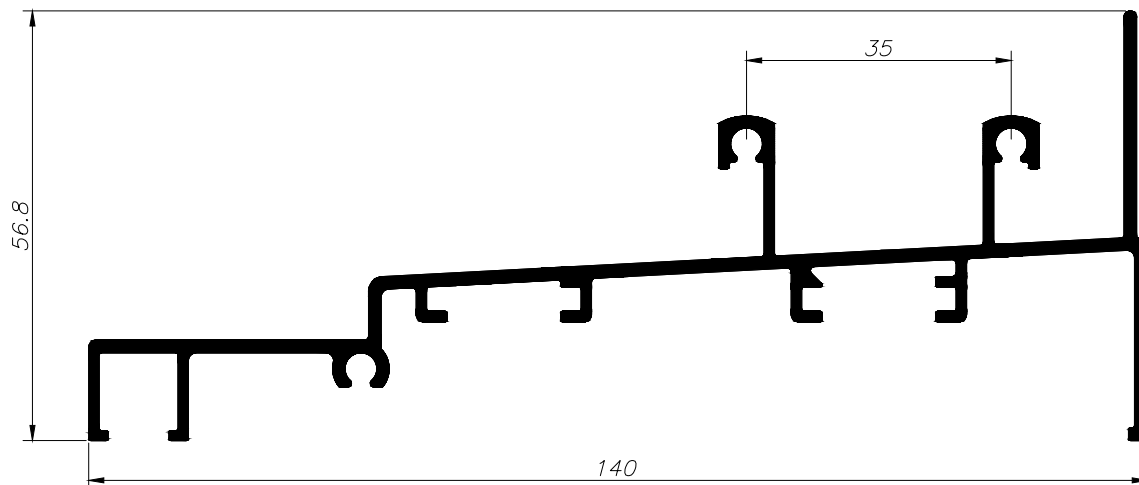
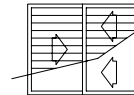

**EMN-010**  
1,496 kg/m

TAMPA INTERNA JANELA / CORRER

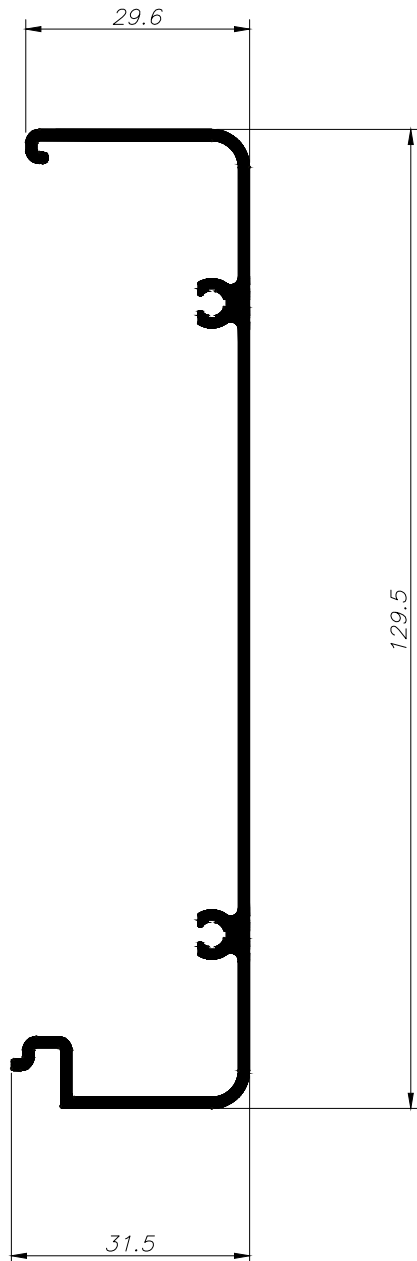
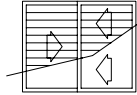

**EMN-608**  
0,814 kg/m



## TAMPA INTERNA INFERIOR

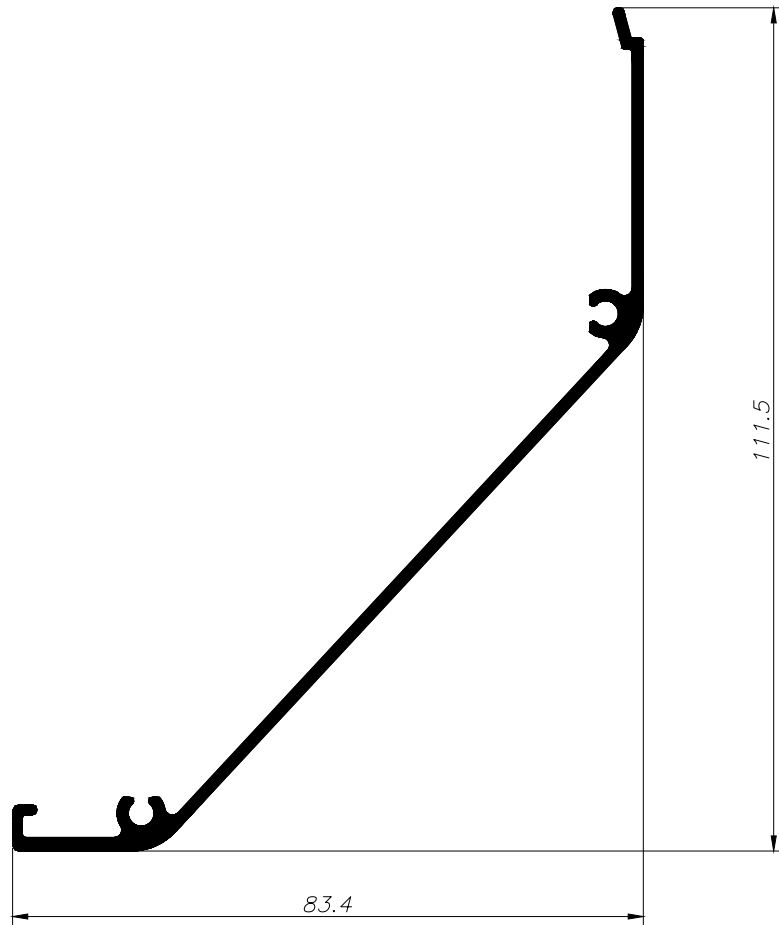

**EMN-005**  
0,890 kg/m

## TAMPA INTERNA SUPERIOR

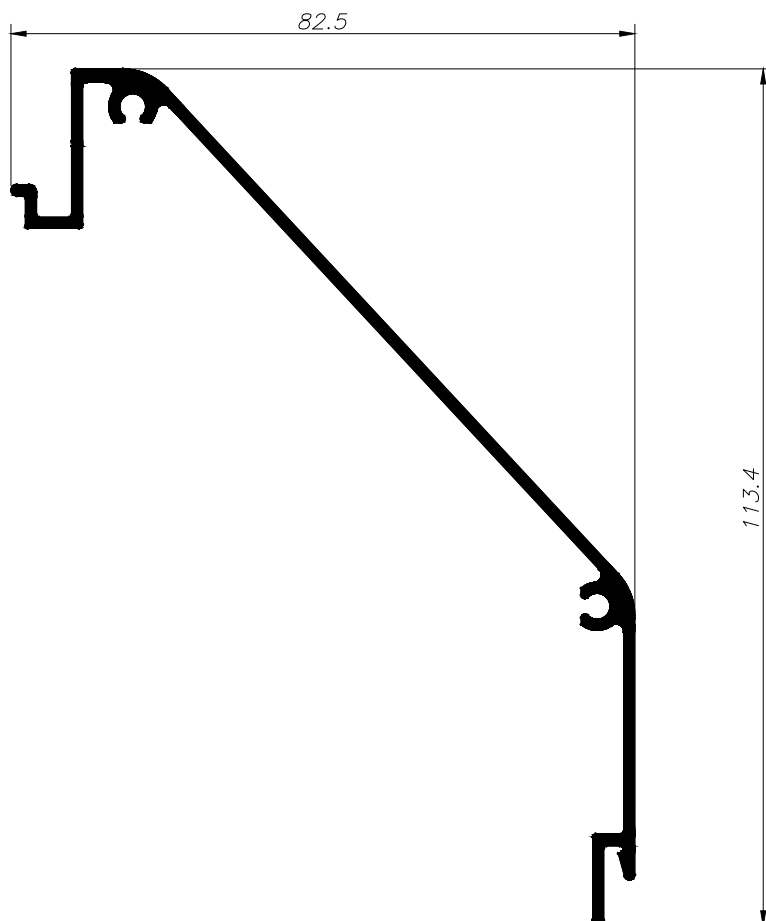

**EMN-006**  
0,890 kg/m

**TAMPA INTERNA PORTA 25 E 30 / CORRER**

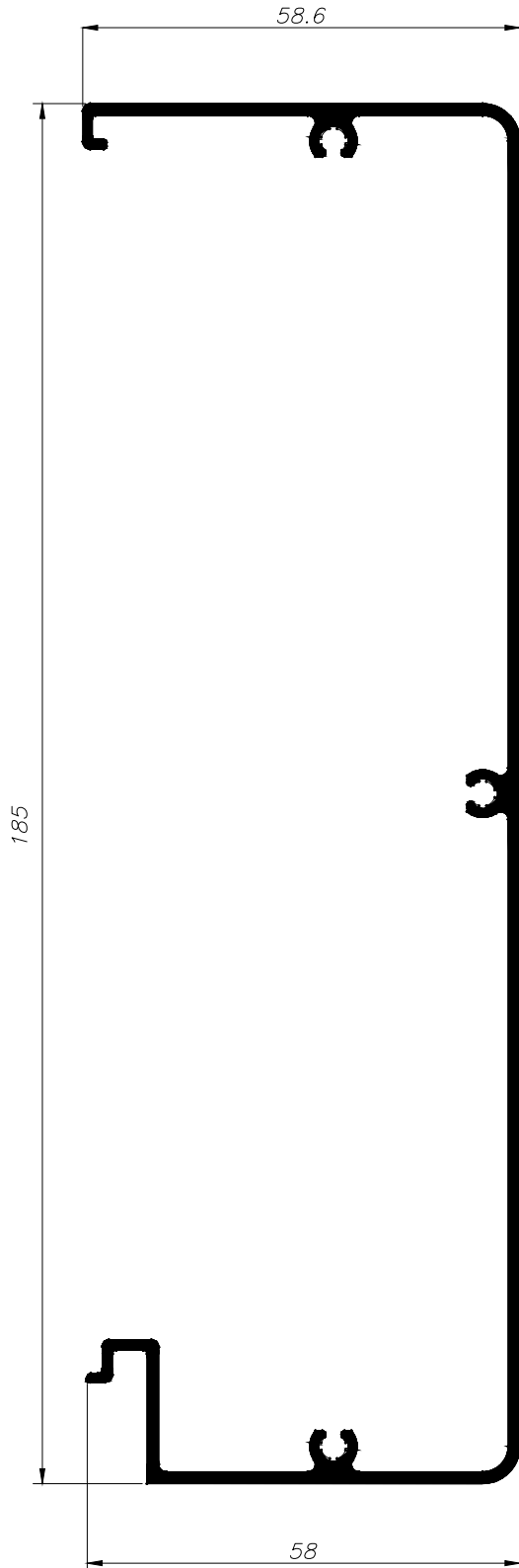
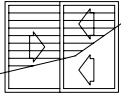

**EMN-032**  
1,550 kg/m

**TAMPA EXTERNA JANELA / CORRER**

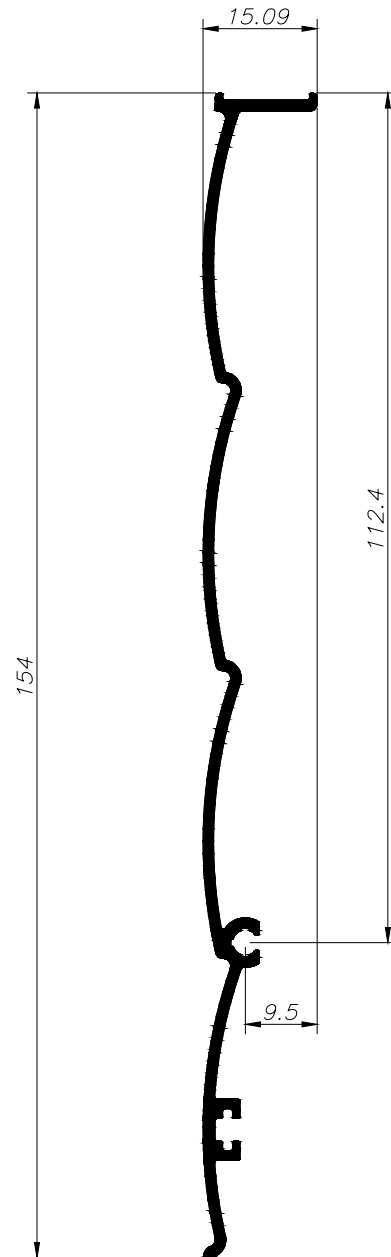
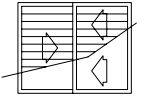

**EMN-008**  
0,737 kg/m

**GUIA ESTEIRA COM CAIXA / CORRER**

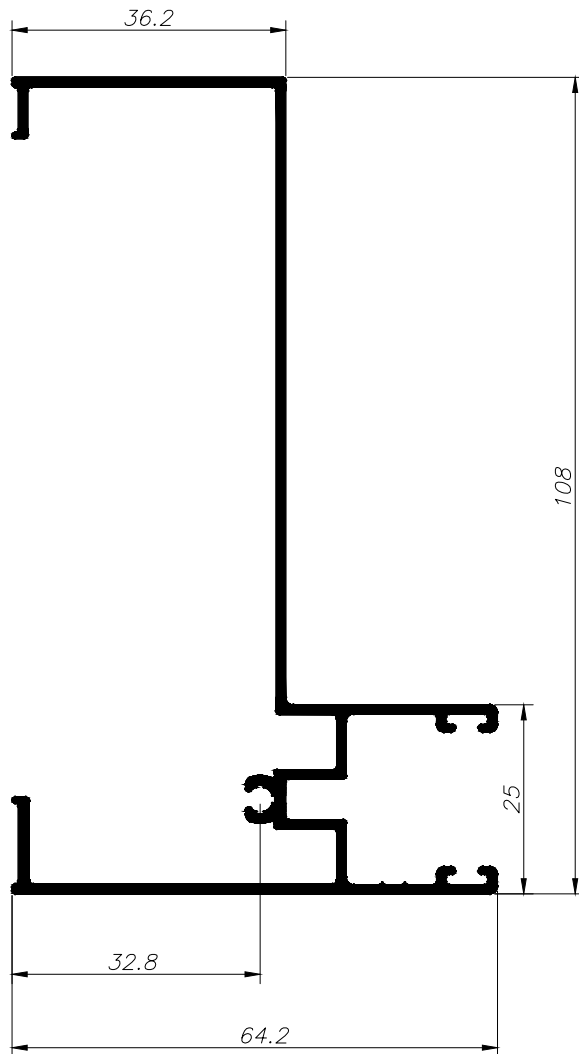
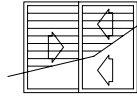

**EMN-500**  
1,020 kg/m

**GUIA ESTEIRA / CORRER**

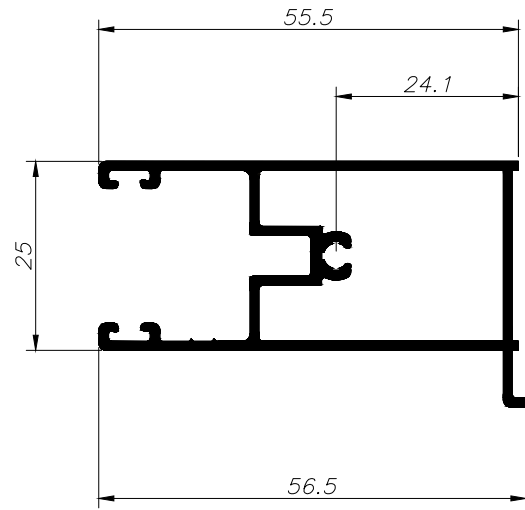
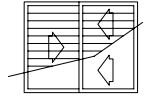

**EMN-007**  
0,676 kg/m

*TUBO OCTAGONAL / CORRER*

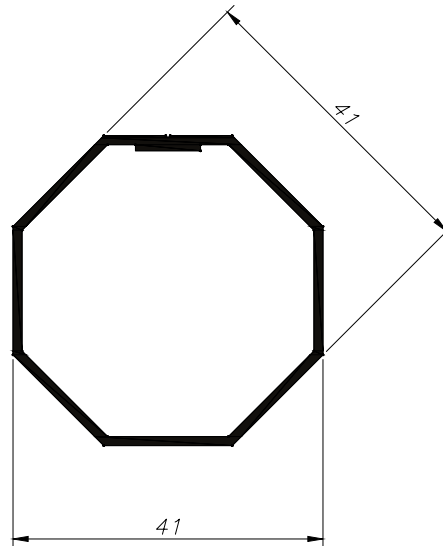
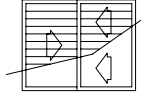

**EMN-178**  
0,447 kg/m

*TUBO OCTAGONAL / CORRER*

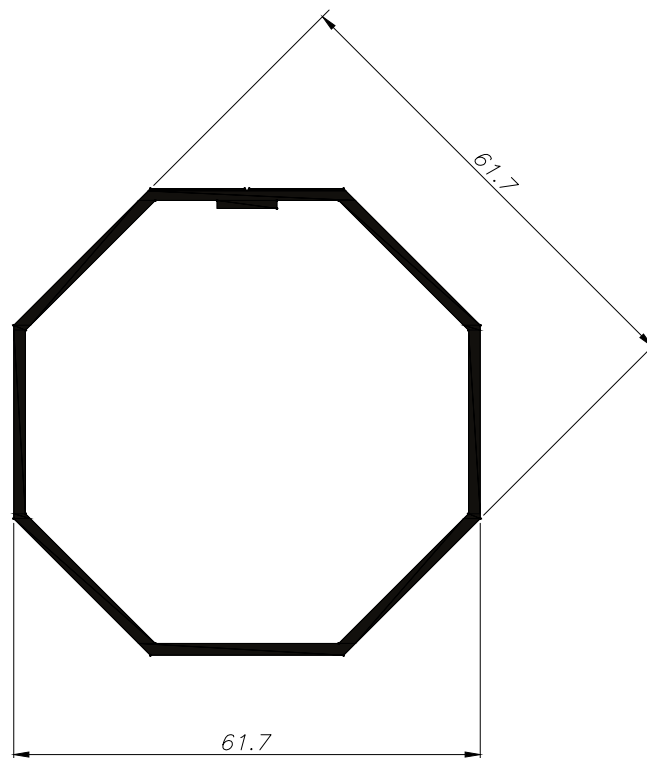
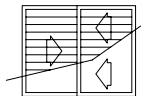

**EMN-015**  
0,859 kg/m

**PERFIL SOLEIRA/ CORRER**

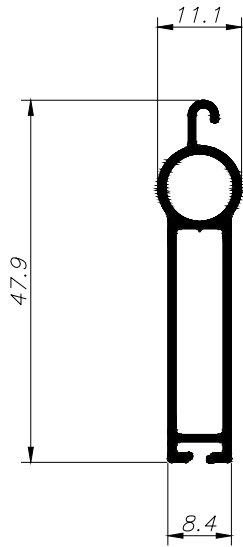

**EMN-055**  
0,342 kg/m

**REMATE/ CORRER**

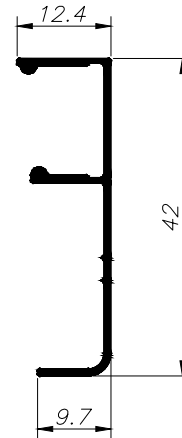

**EMN-014**  
0,190 kg/m

**CAIXA FITA / CORRER**

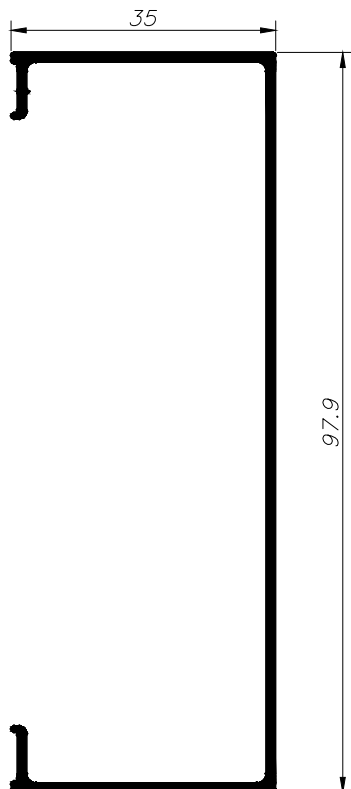

**EMN-050**  
0,641 kg/m

**COMPLEMENTO/ CORRER**

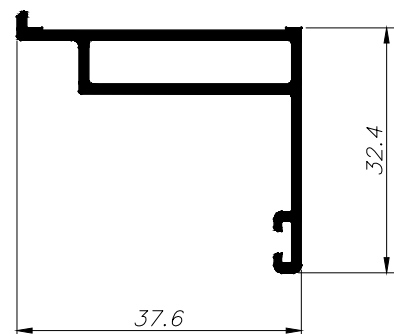

**EMN-019**  
0,393 kg/m

**MONTANTE LATERAL 2 PLANOS / CORRER**

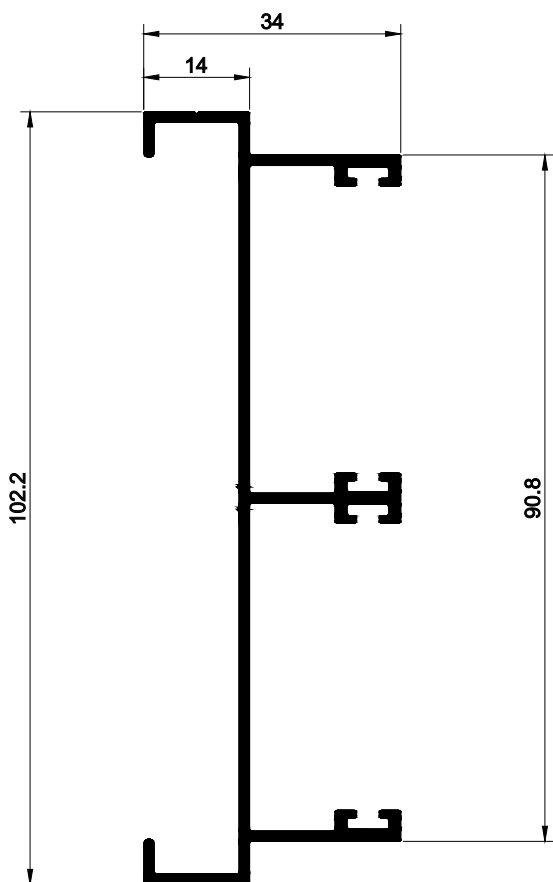
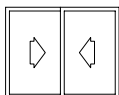

**ELG-045**  
0,873 kg/m

**MONTANTE LATERAL 2 PLANOS LISO / CORRER**

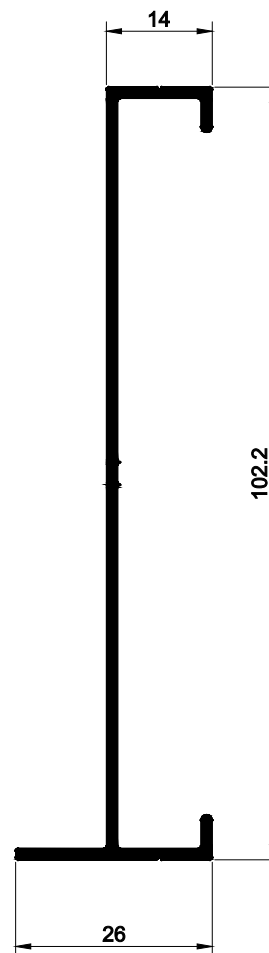
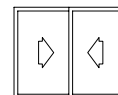

**ELG-002**  
0,602 kg/m

**MARCO INFERIOR E SUPERIOR BANDEIRA E PEITORIL / CORRER**

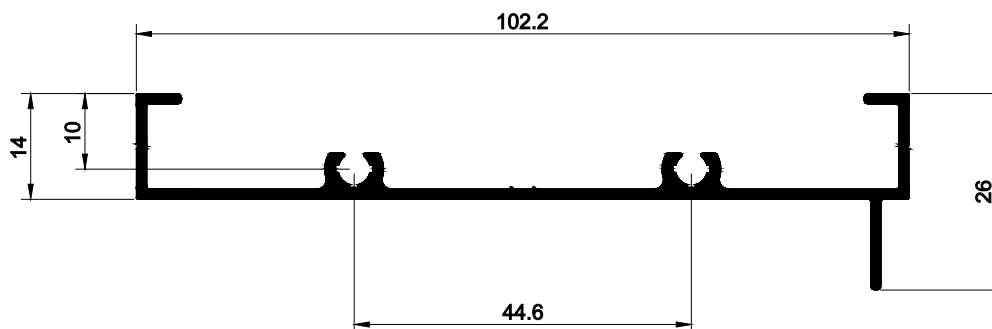
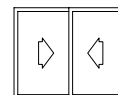

**ELG-003**  
0,675 kg/m

## TRILHO SUPERIOR 2 PLANOS / CORRER

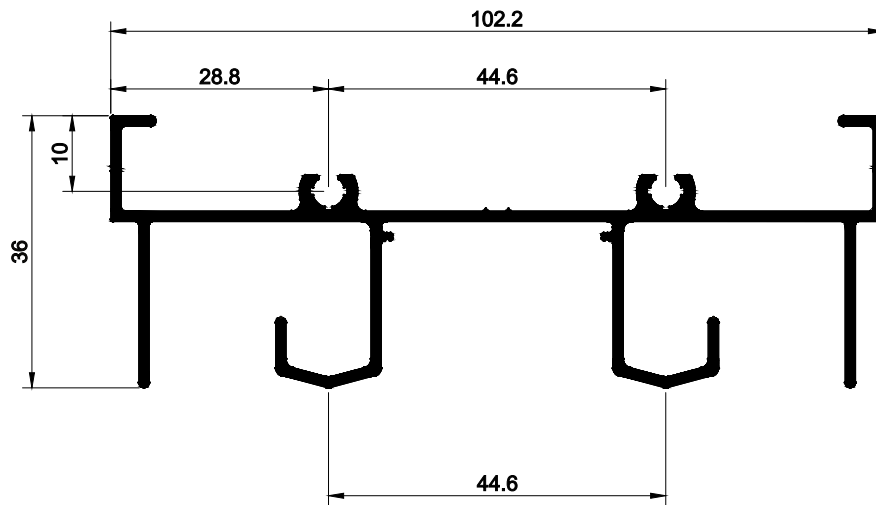

**ELG-044**  
1,106 kg/m

## TRILHO INFERIOR 2 PLANOS / CORRER

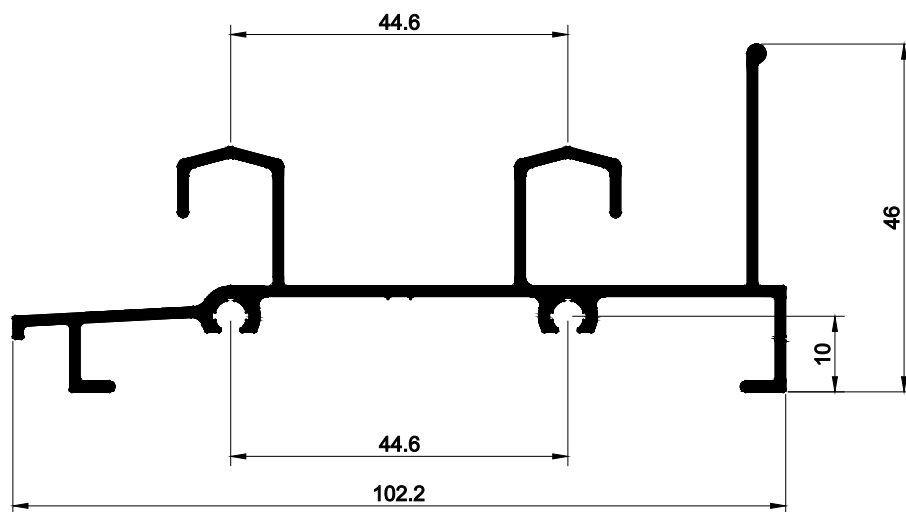

**ELG-047**  
1,014 kg/m

**TRILHO BANDEIRA 2 PLANOS / CORRER**

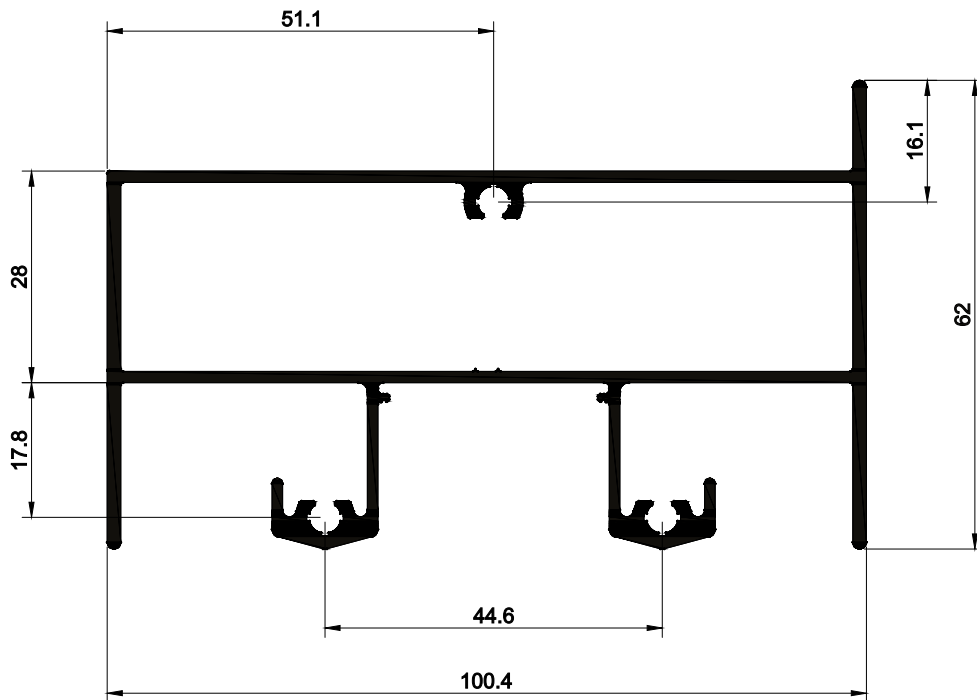
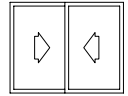

**ELG-004**  
1,826 kg/m

**MONTANTE PEITORIL 2 PLANOS / CORRER**

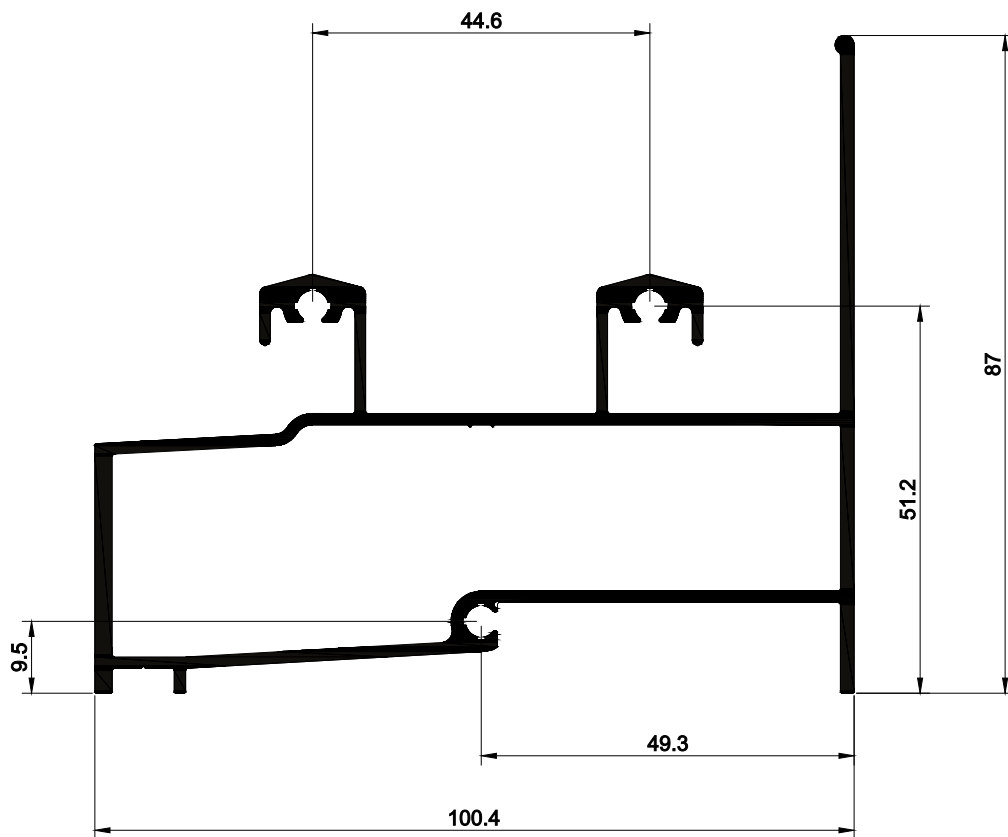
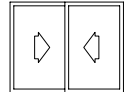

**ELG-005**  
1,891 kg/m



**MONT. LAT. 4 PLANOS / CORRER**

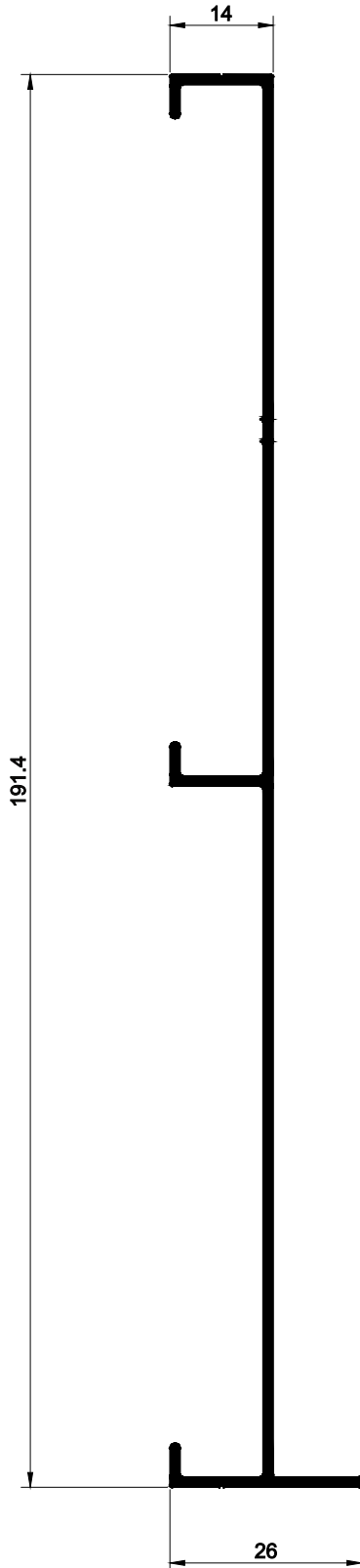
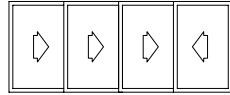

**ELG-072**  
0,965 kg/m

**MATA JUNTA POSTIÇO / CORRER**

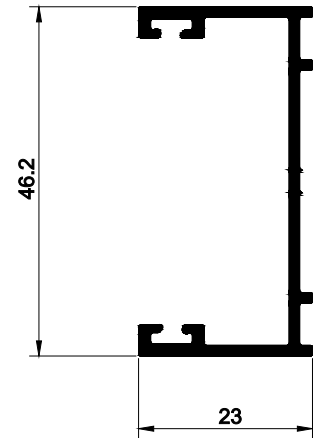
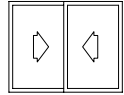

**ELG-028**  
0,419 kg/m

**PISTA POSTIÇO / CORRER**

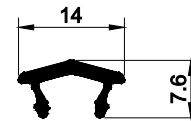
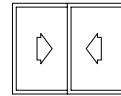

**ELG-111**  
0,092 kg/m

**TRILHO POSTIÇO / CORRER**

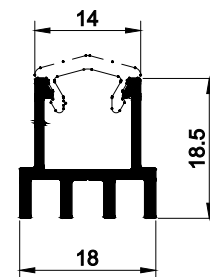
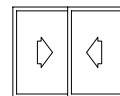

**ELG-157**  
0,238 kg/m

*MONTANTE LATERAL 3 PLANOS / CORRER*

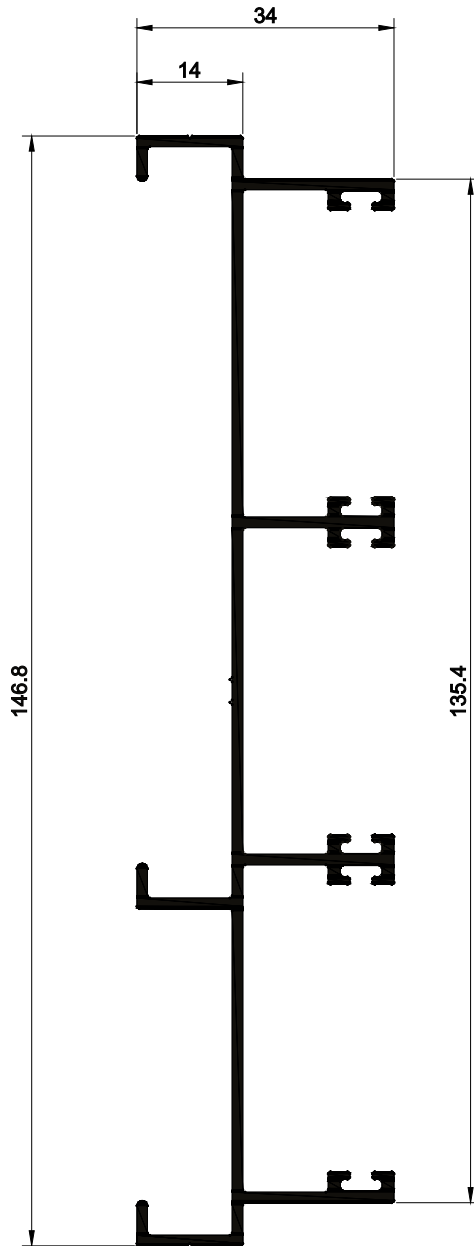
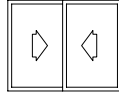

**ELG-064**  
1,244 kg/m

*MONTANTE LATERAL 3 PLANOS LISO / CORRER*

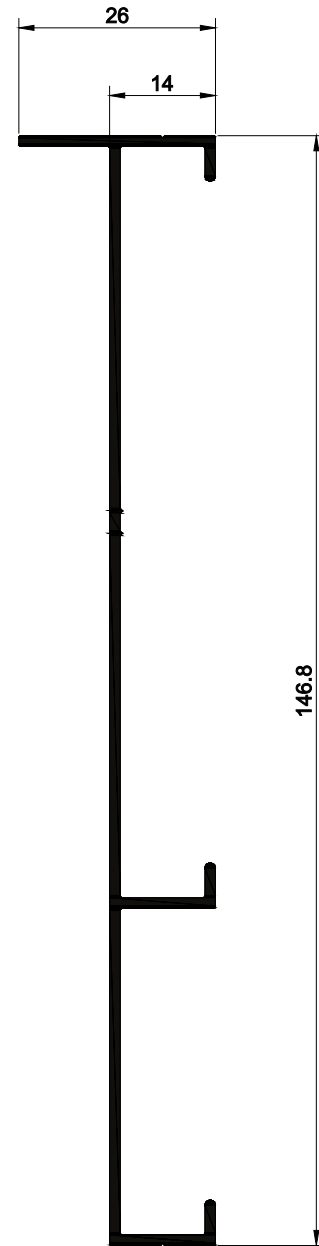
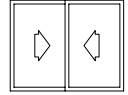

**ELG-158**  
0,797 kg/m

TRILHO SUP. 4 PLANOS / CORRER

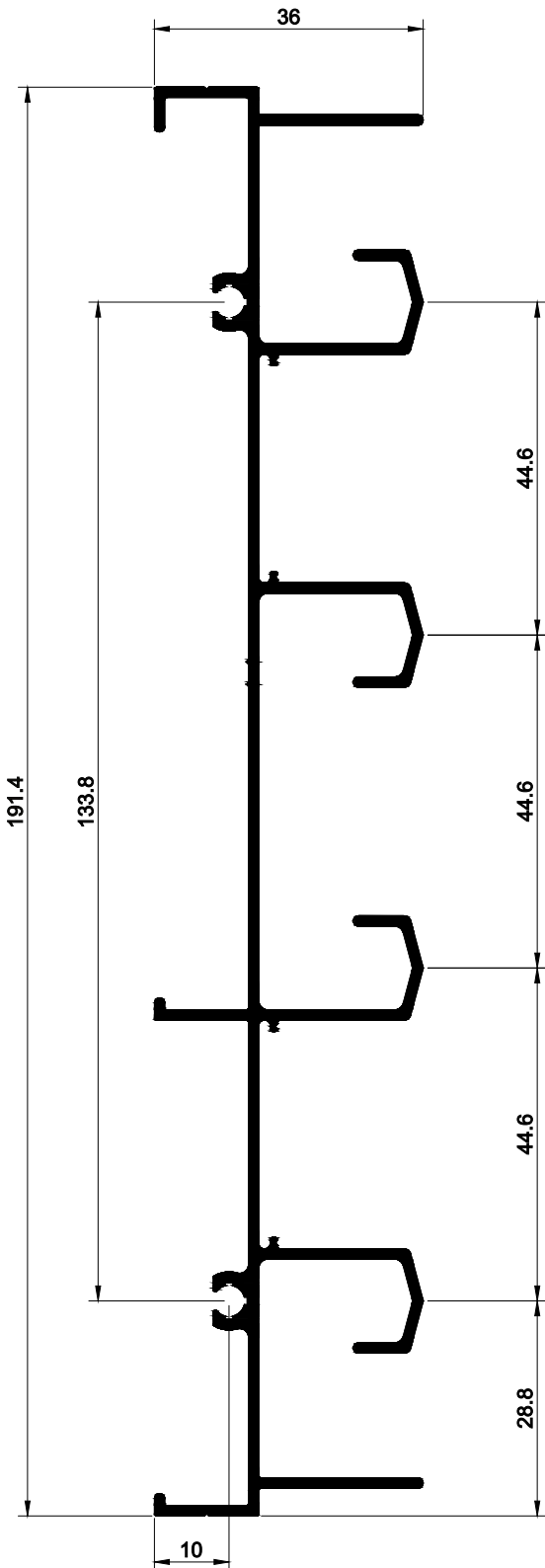
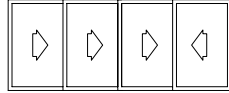

**ELG-070**  
1,797 kg/m

TRILHO INF. 4 PLANOS / CORRER

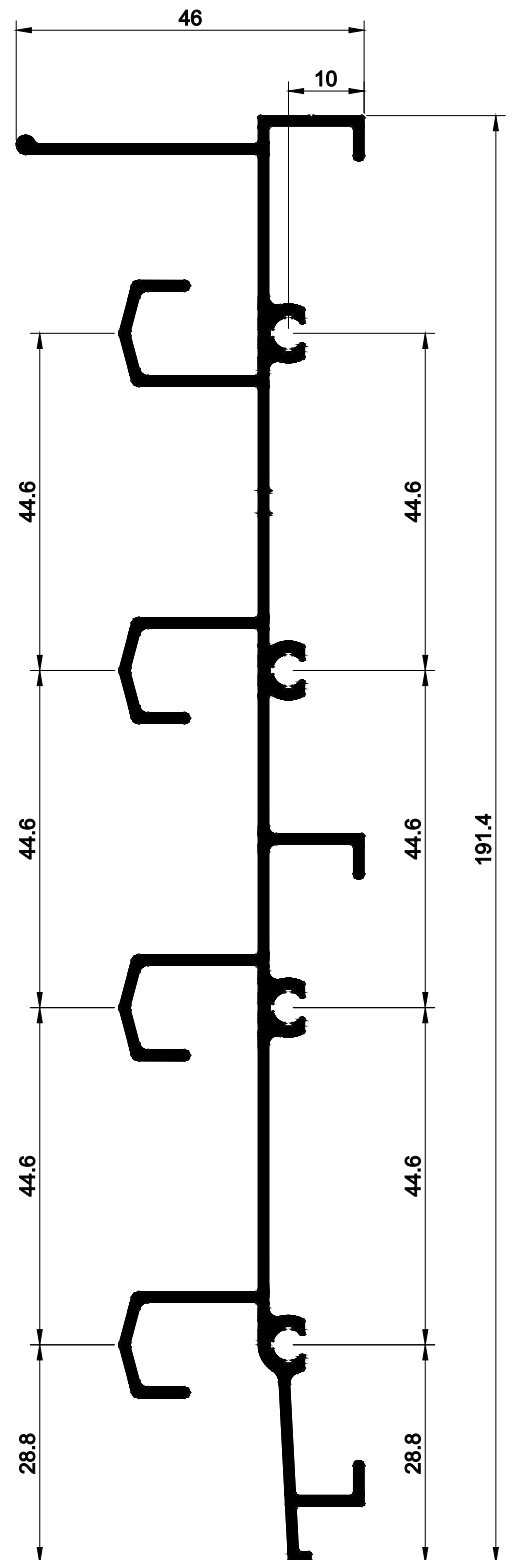
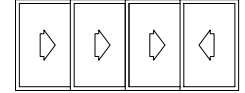

**ELG-071**  
1,800 kg/m

## TRILHO BANDEIRA 3 PLANOS / CORRER

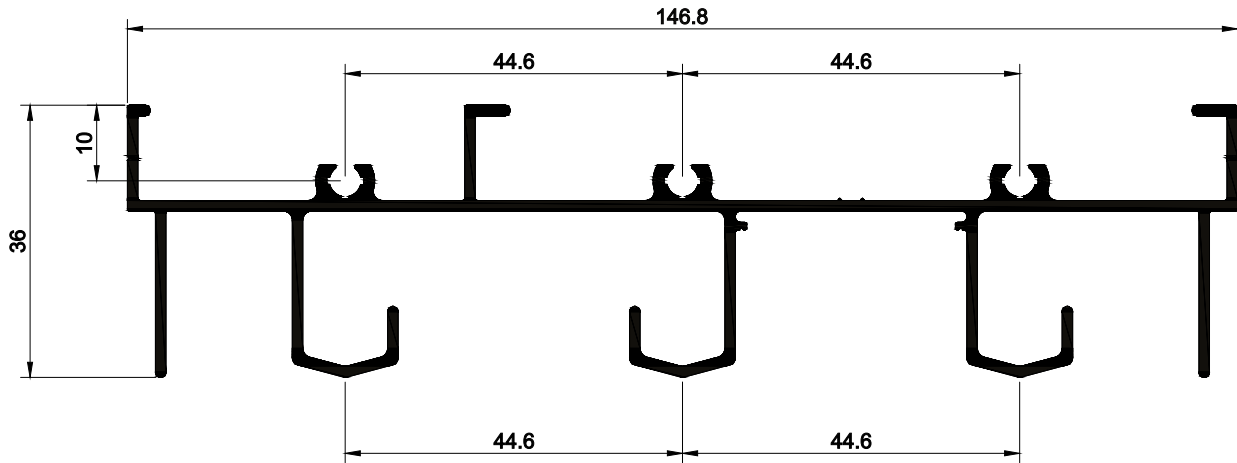
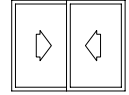

**ELG-062**  
1,537kg/m

## MONTANTE PEITORIL 3 PLANOS / CORRER

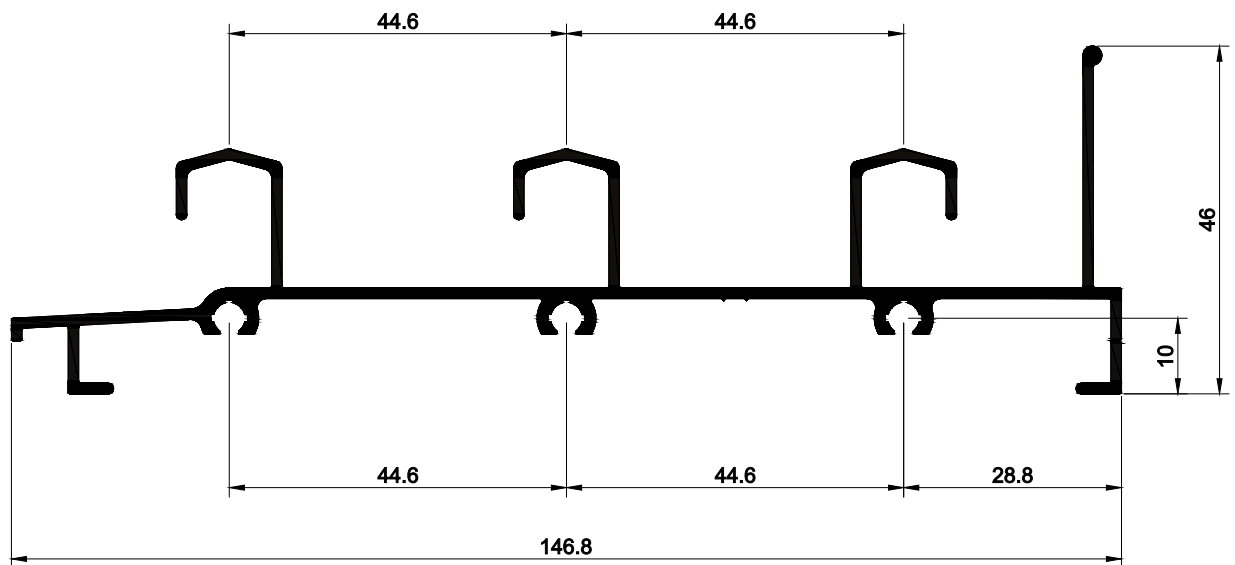
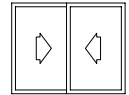

**ELG-066**  
1,372kg/m

**TRAVESSA INFERIOR - SUPERIOR / CORRER**

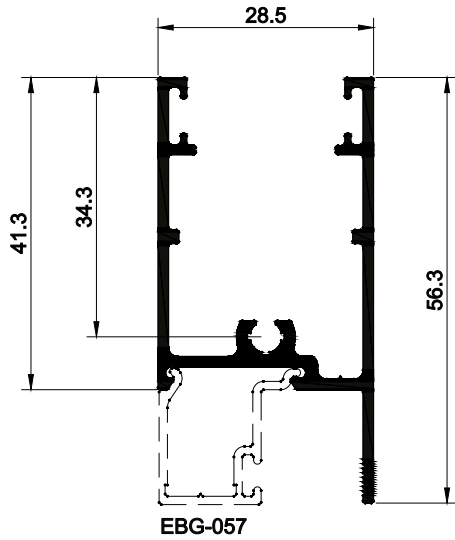

**ELG-006**  
0,613 kg/m

**TRAVESSA CENTRAL / CORRER**

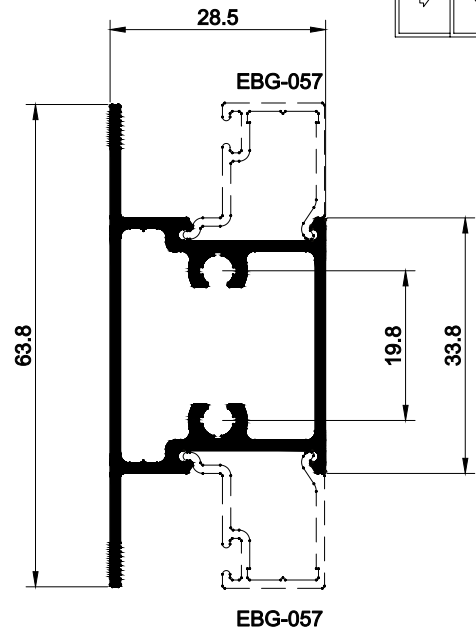

**ELG-055**  
0,718 kg/m

**TRAVESSA INFERIOR / CORRER**

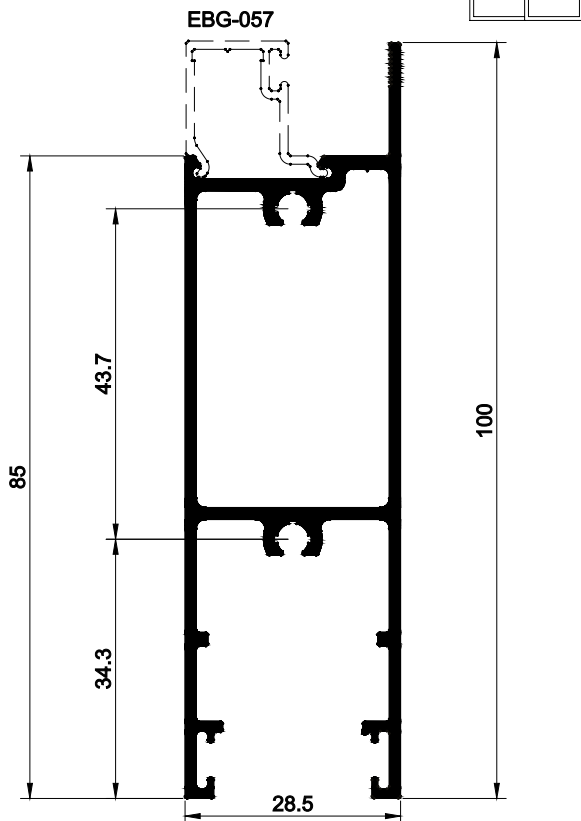

**ELG-007**  
1,176 kg/m

**INVERSOR BAGUETE**

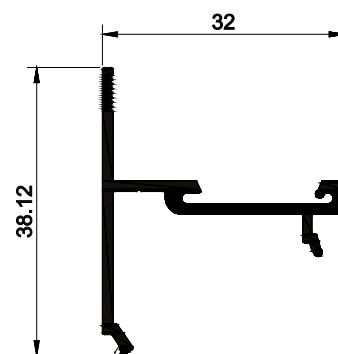

**ELG-077**  
0,329 kg/m

**MONTANTE / CORRER**

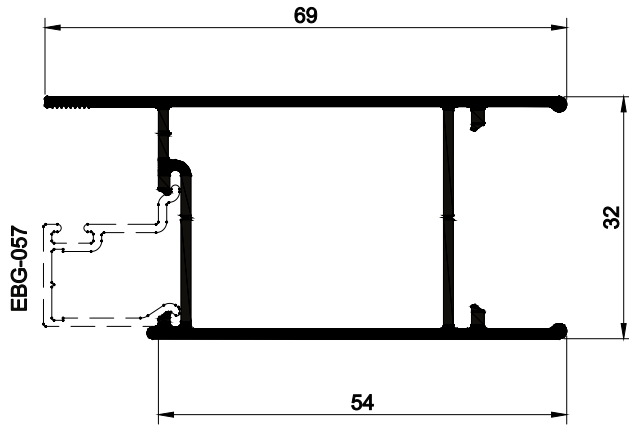
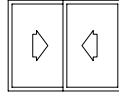

**ELG-050**  
0,710 kg/m

**MONTANTE CENTRAL / CORRER**

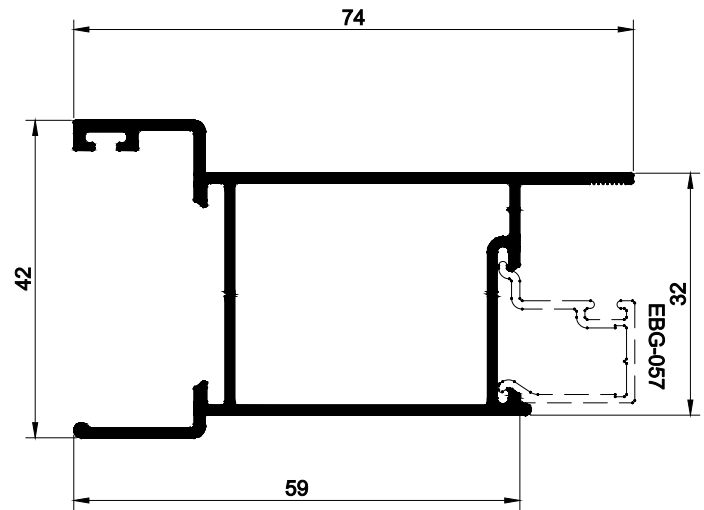
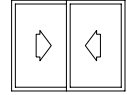

**ELG-051**  
0,812 kg/m

**MÃO DE AMIGO / CORRER**

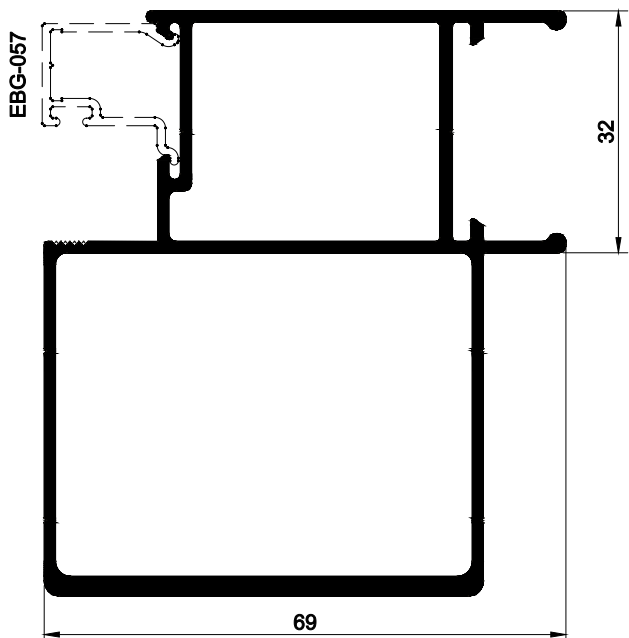
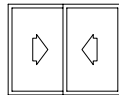

**ELG-054**  
1,581 kg/m

**MÃO DE AMIGO / CORRER**

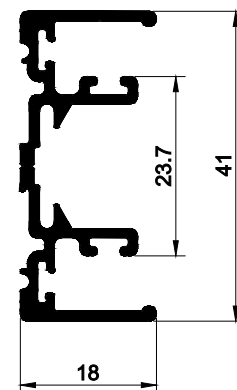
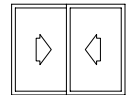

**ELG-300**  
0,491 kg/m

MÃO DE AMIGO / CORRER

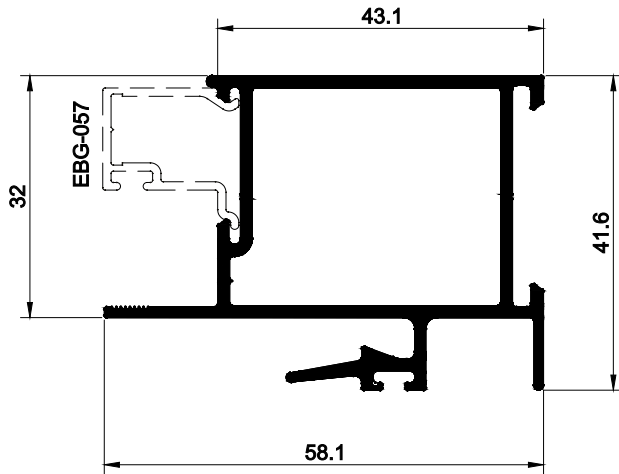
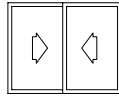

**ELG-048**  
0,913 kg/m

MÃO DE AMIGO / CORRER

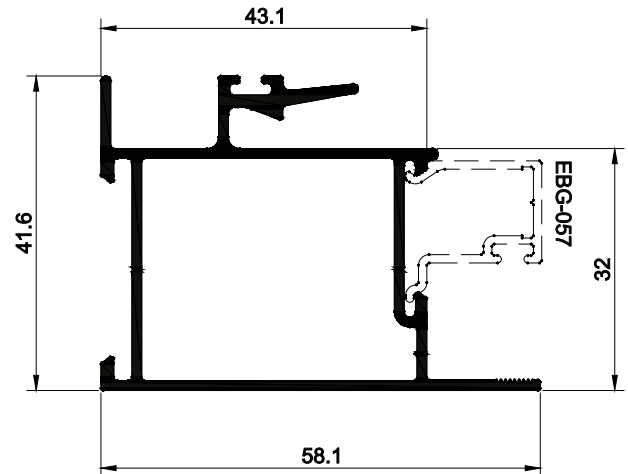
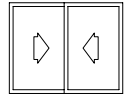

**ELG-049**  
0,805 kg/m

MONTANTE / CORRER

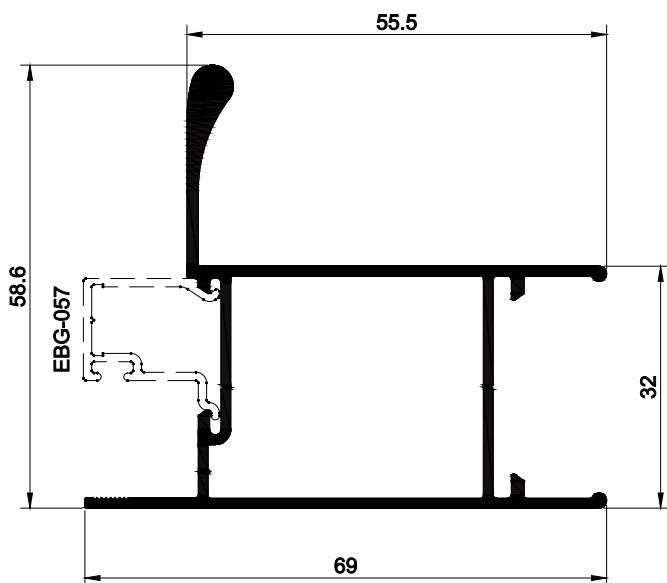
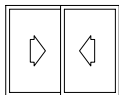

**ELG-017**  
0,902 kg/m

MONTANTE CENTRAL / CORRER

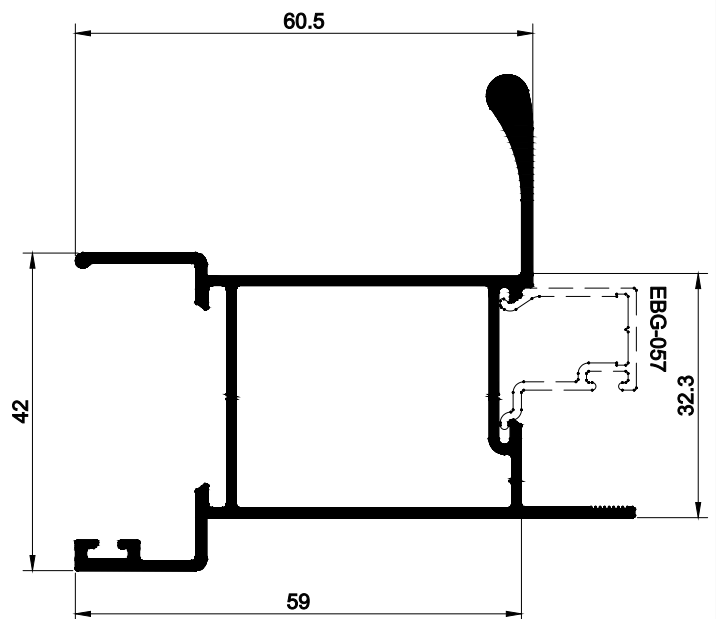
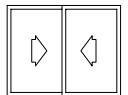

**ELG-020**  
1,005 kg/m

**PERFIL MARCO 45° / MAXIM-AR E GIRO**

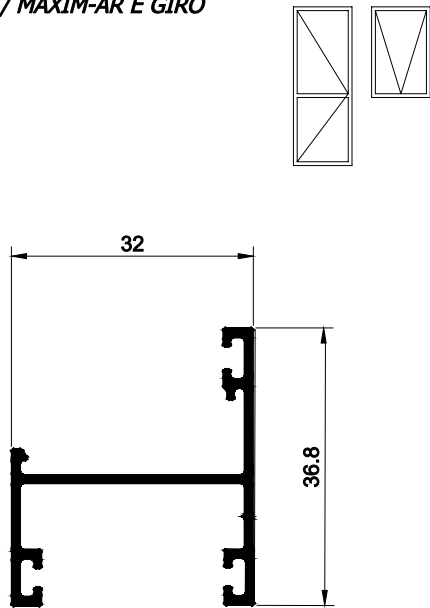

**ELG-068**  
0,369 kg/m

**PERFIL FOLHA / MAXIM-AR**

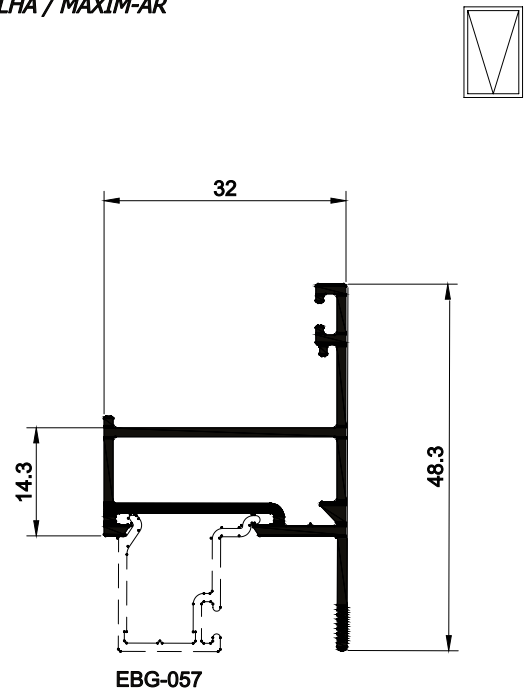

**ELG-085**  
0,480 kg/m

**TRAVESSA FOLHA / MAXIM-AR**

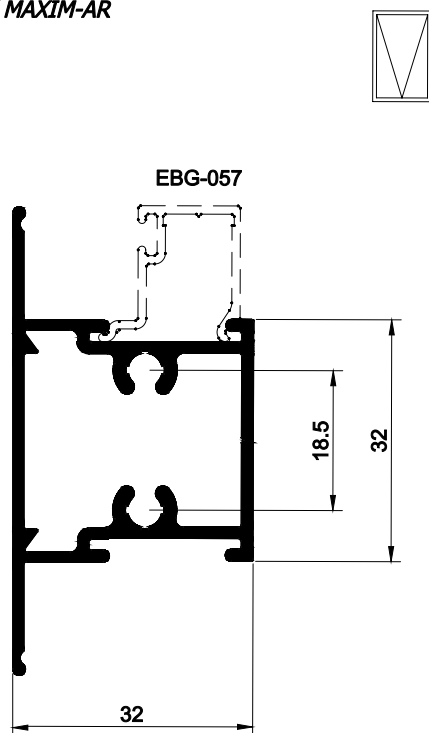

**ELG-079**  
0,816 kg/m

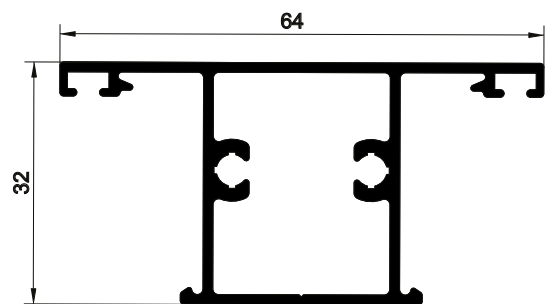

**ELG-074**  
0,733 kg/m



## MONTANTE / CORRER

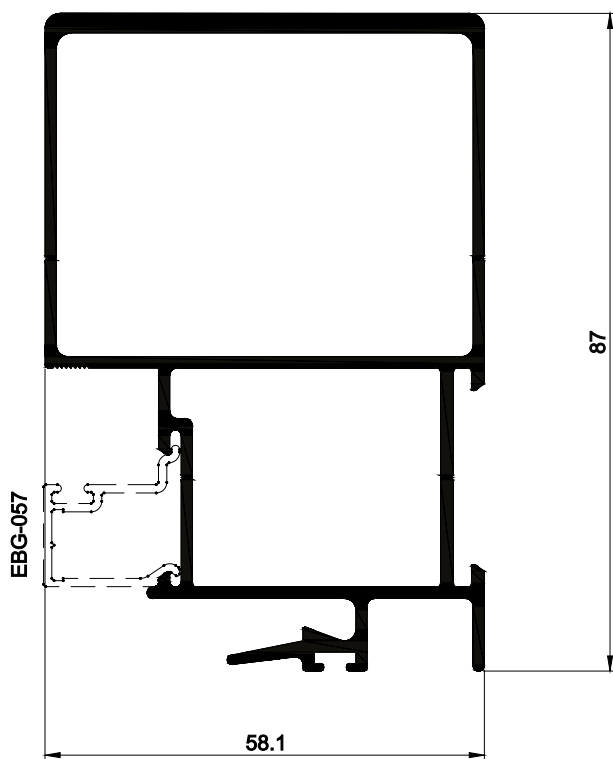
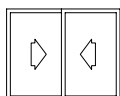

**ELG-052**  
1,666 kg/m

## MÃO DE AMIGO / CORRER

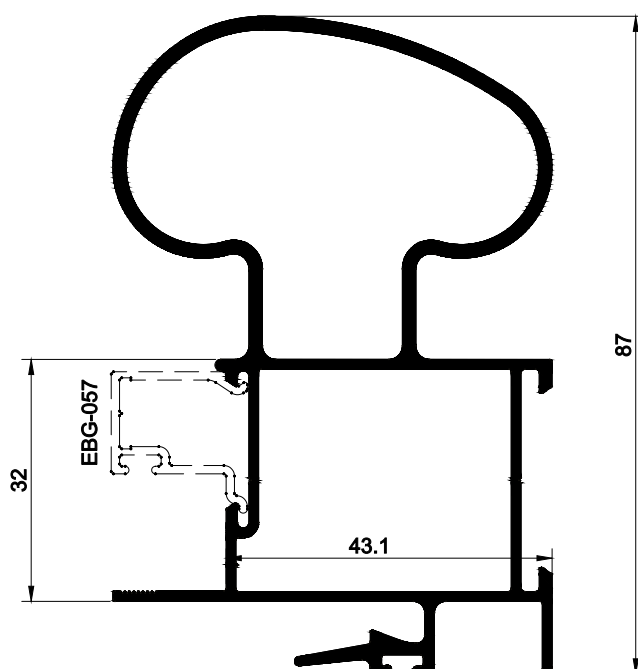
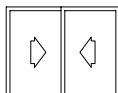

**ELG-021**  
1,734 kg/m

**PERFIL FOLHA 45° / GIRO**

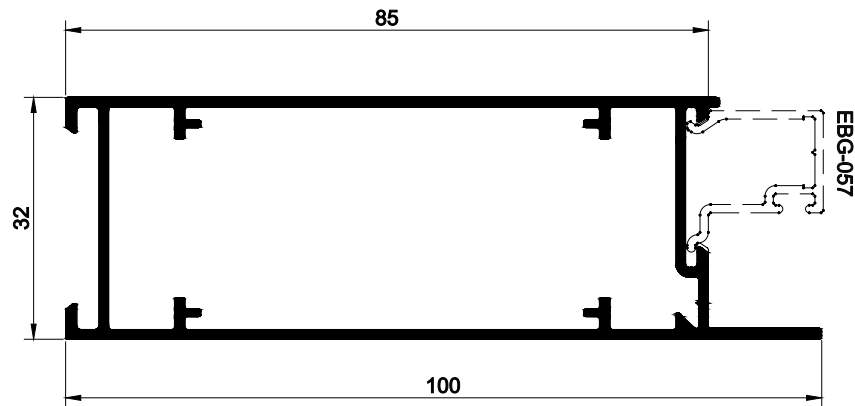

**ELG-042**  
1,020 kg/m

**PERFIL FOLHA 45° / GIRO**

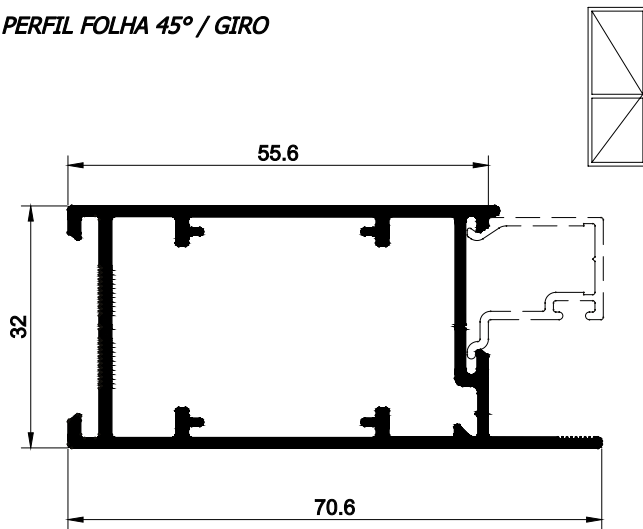

**ELG-043**  
0,878 kg/m

**TRAVESSA INFERIOR / GIRO**

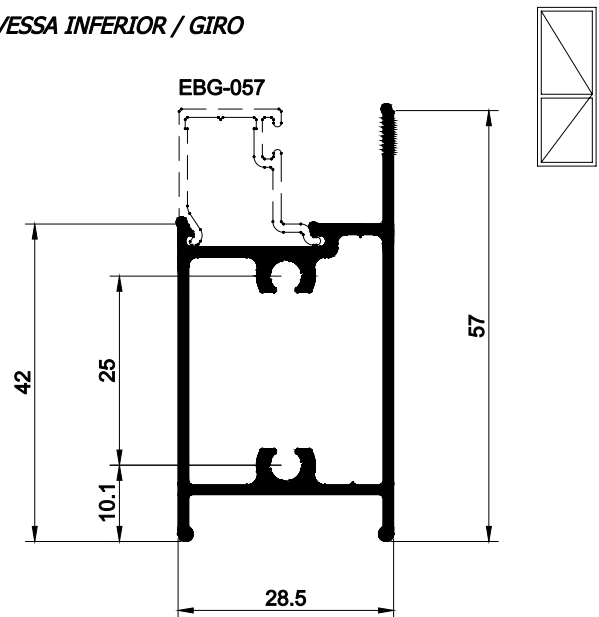

**ELG-058**  
0,699 kg/m

**BAGUETE**

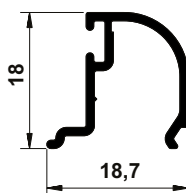

**ELG-026**  
0,157 kg/m

**BAGUETE**

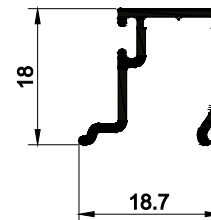

**EBG-057**  
0,168 kg/m

**COLUNA / MAXIM-AR**

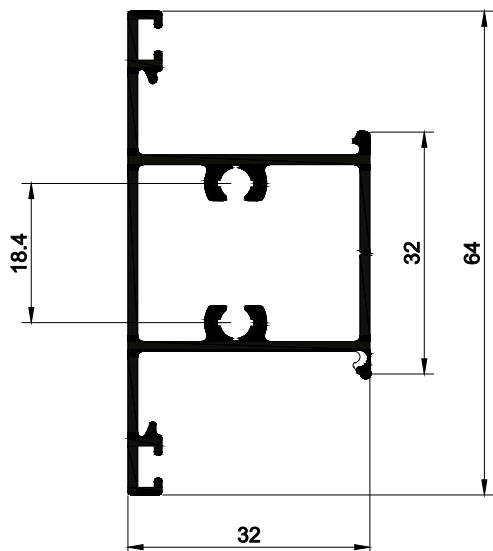
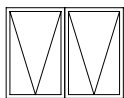

**ELG-074**  
0,733 kg/m

**PINGADEIRA / MAXIM-AR**

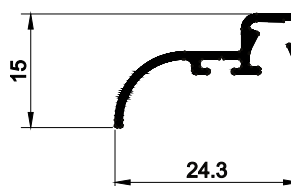

**ELG-091**  
0,130 kg/m

**PERFIL BANDEIRA-PEITORIL / MAXIM-AR**

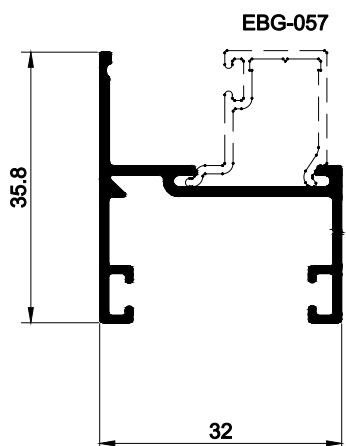
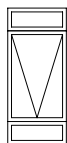

**ELG-083**  
0,376 kg/m

**MARCO / GIRO**

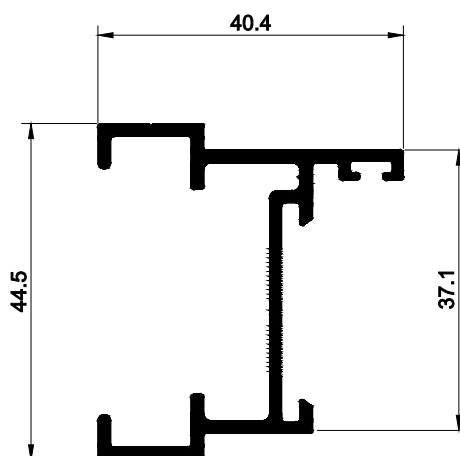

**ELG-056**  
0,626 kg/m

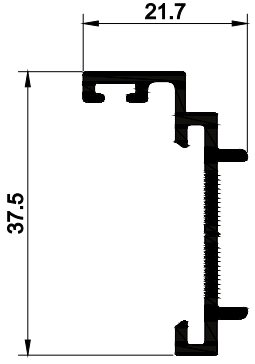
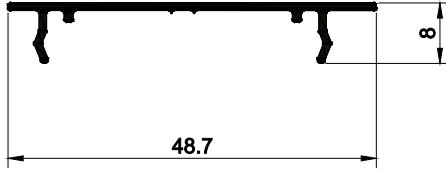
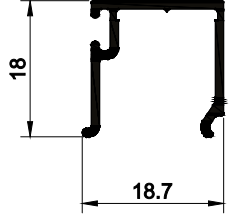
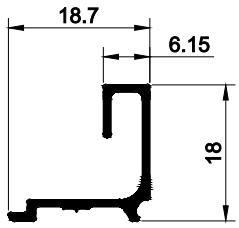
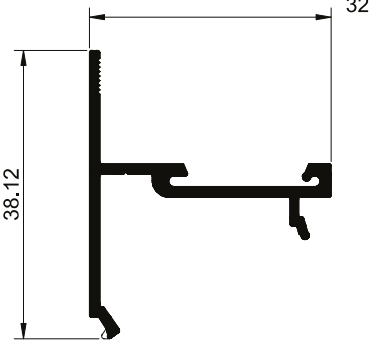
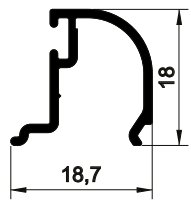
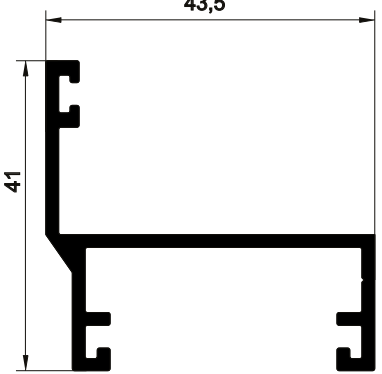
<p><b>POSTIÇO MATA-JUNTA</b></p>  <p><b>ELG-016</b> 0,311 kg/m</p>	<p><b>TAMPA</b></p>  <p><b>ELG-046</b> 0,181 kg/m</p>	
<p><b>BAGUETE</b></p>  <p><b>ELG-059</b> 0,170 kg/m</p>	<p><b>PORTA PALHETA</b></p>  <p><b>ELG-027</b> 0,135 kg/m</p>	
<p><b>INVERSOR BAGUETE</b></p>  <p><b>ELG-077</b> 0,329 kg/m</p>	 <p><b>ELG-026</b> 0,159 kg/m</p>	 <p><b>E42-042</b> 0,570 kg/m</p>

**COMPLEMENTO**

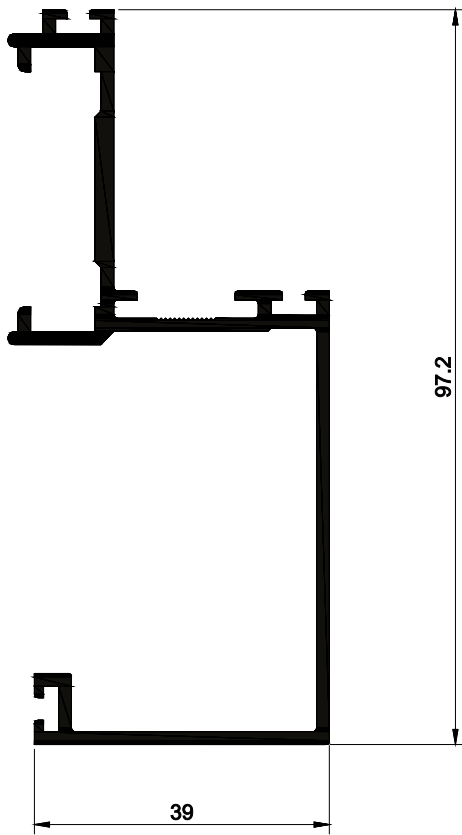

**EFC-243**  
1,097 kg/m

**COLUNA**

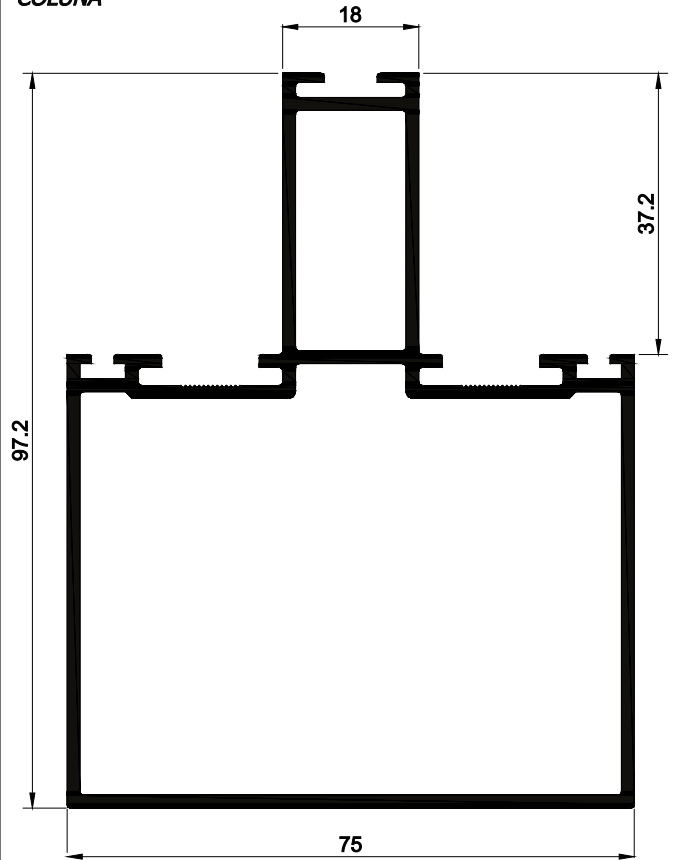

**EFC-202**  
1,791 kg/m

**COLUNA**

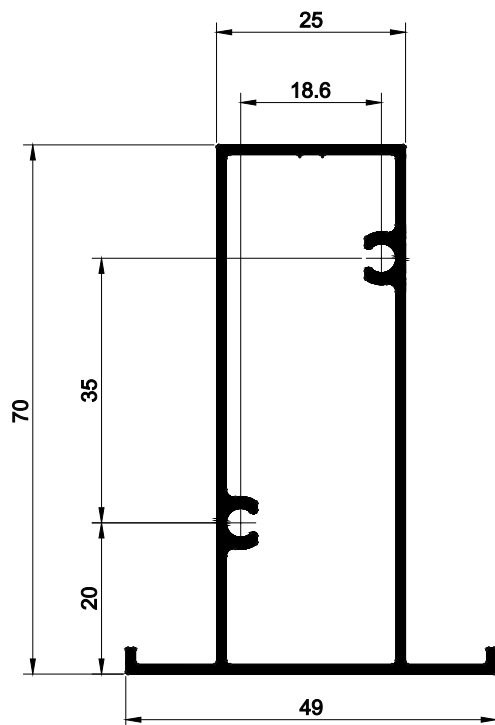

**ELG-070**  
0,835 kg/m

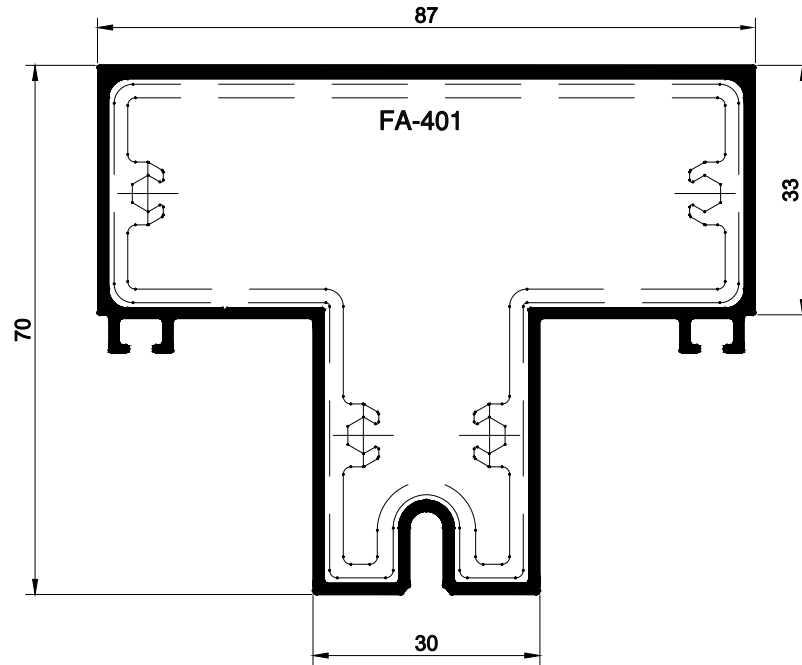

**EFA-400**  
1,473 kg/m

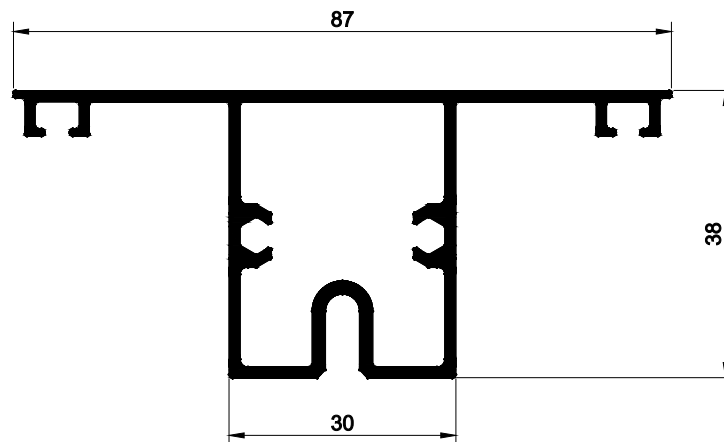

**EFA-204**  
1,010 kg/m

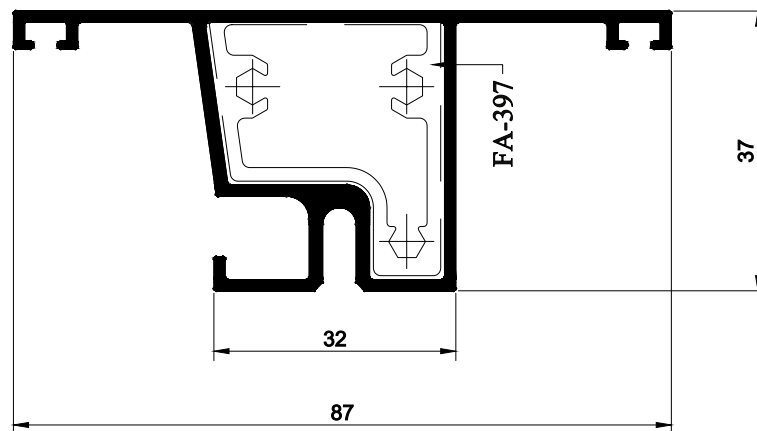

**EFA-211**  
0,993 kg/m

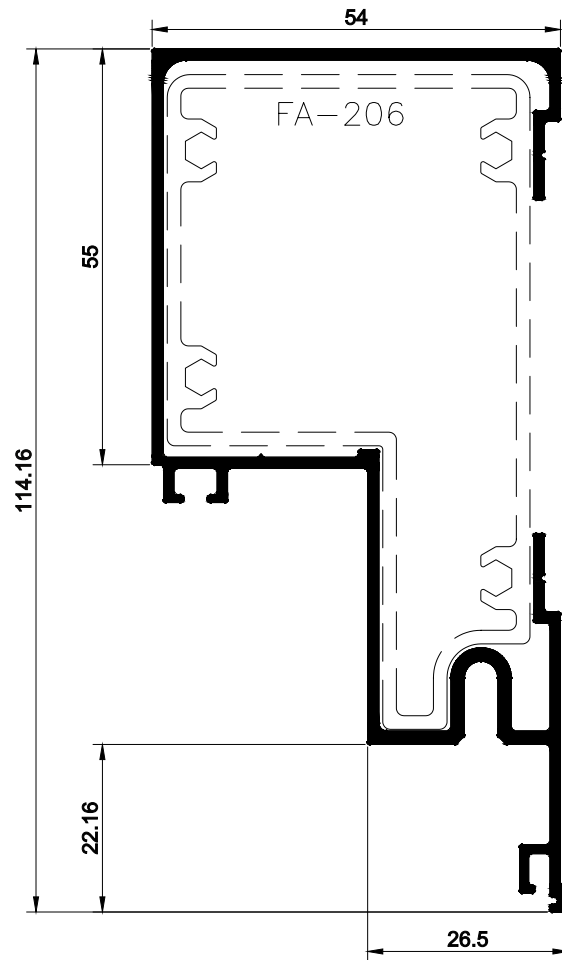

**EFA-235**  
1,275 kg/m

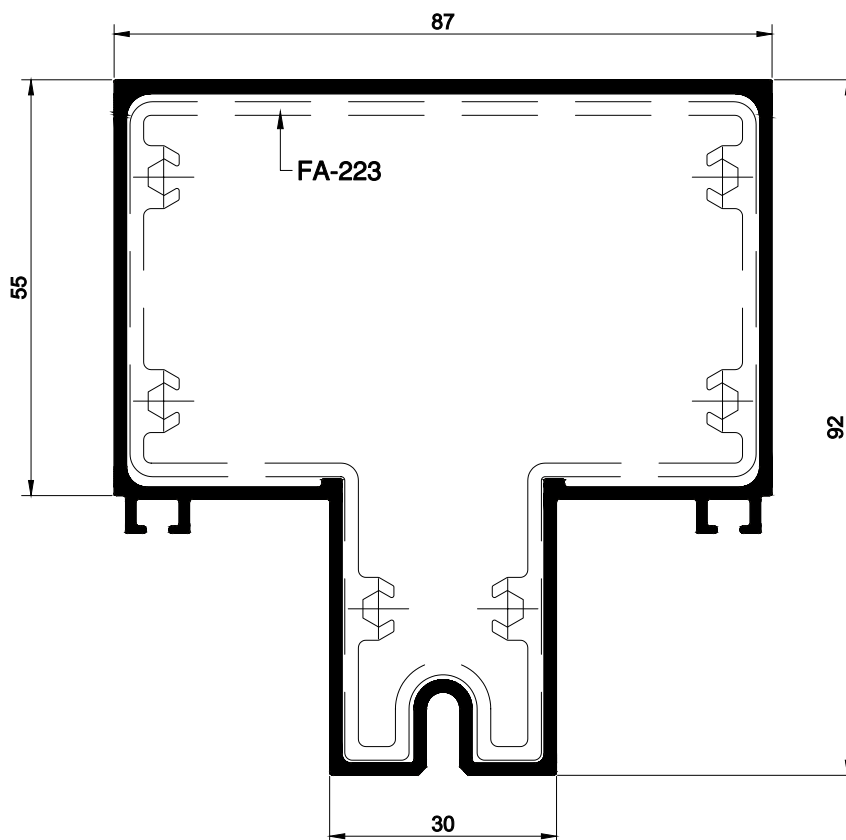

**EFA-200**  
1,813 kg/m

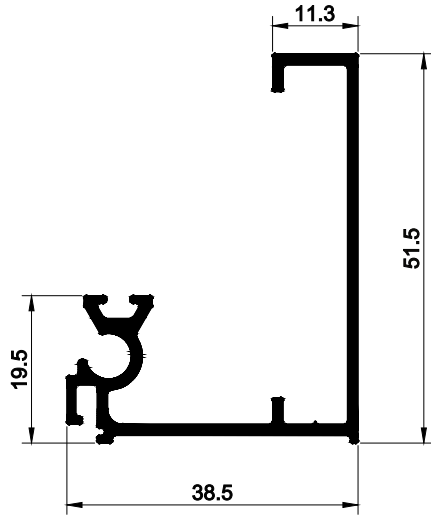

**EFA-228**  
0,571 kg/m

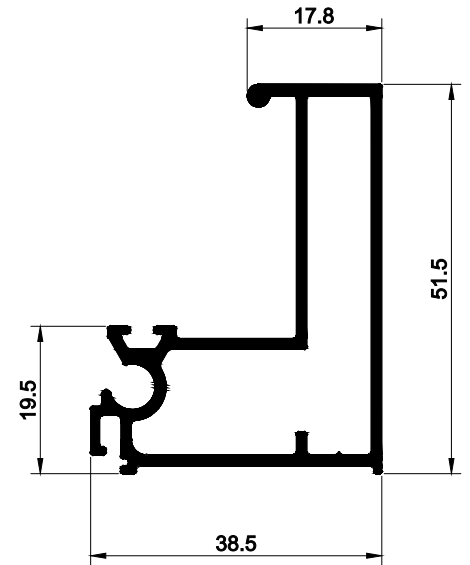

**EFA-230**  
0,780 kg/m

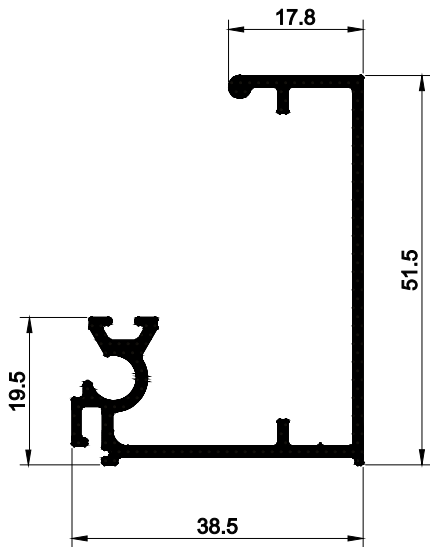

**EFA-232**  
0,604 kg/m

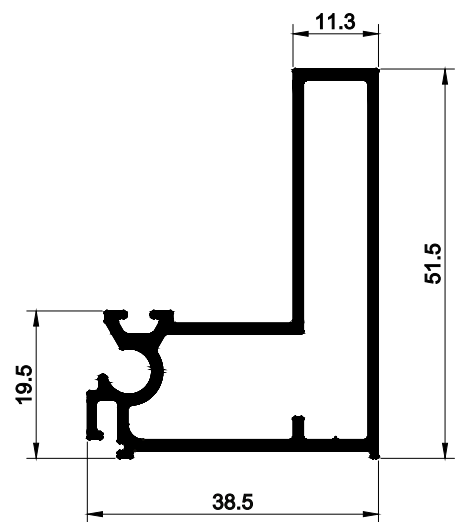

**EFA-245**  
0,745 kg/m

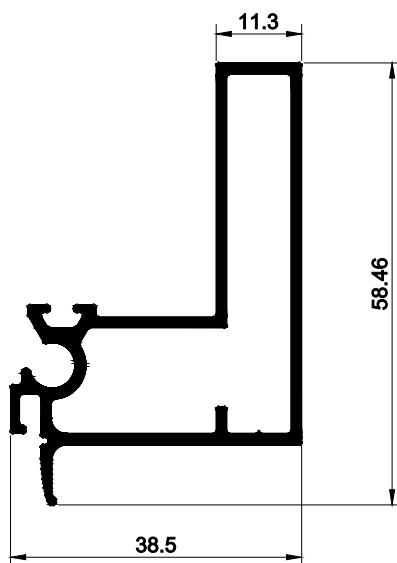

**EFA-255**  
0,770 kg/m

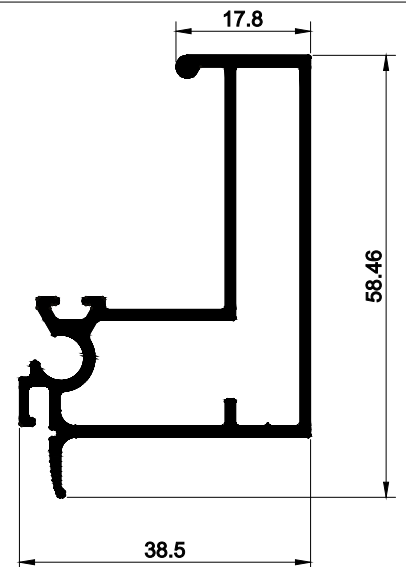

**EFA-256**  
0,805 kg/m



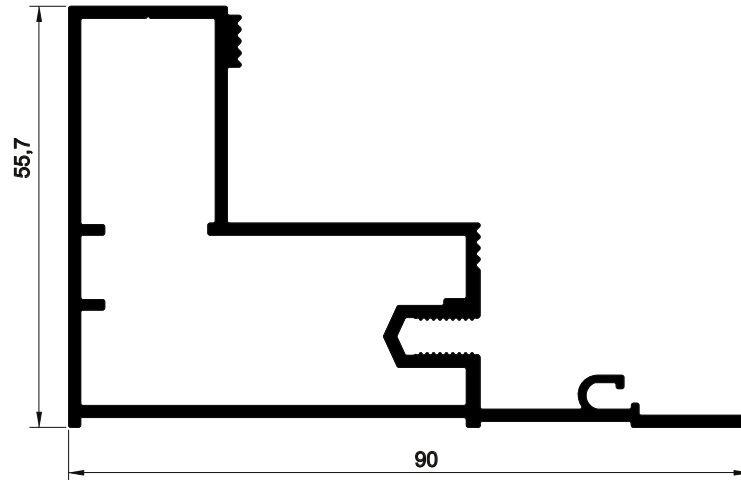

**EFA-012**  
1,275 kg/m

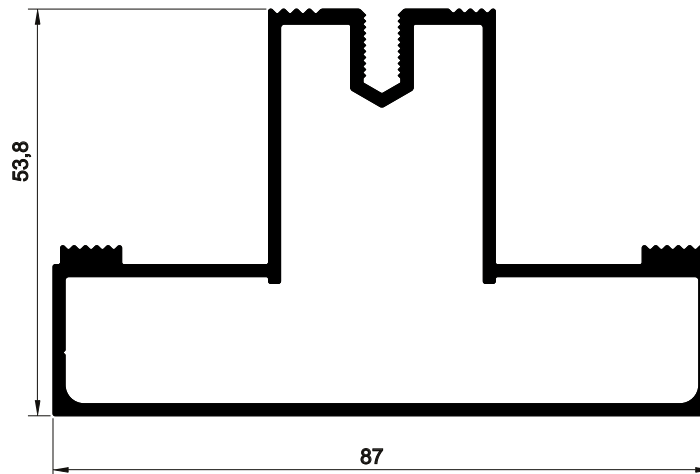

**EFA-013**  
1,408 kg/m

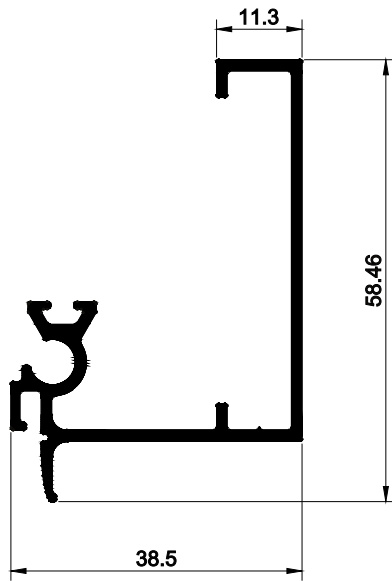

**EFA-258**  
0,593 kg/m

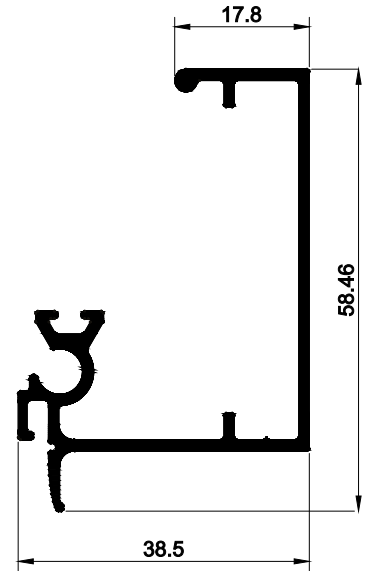

**EFA-259**  
0,629 kg/m

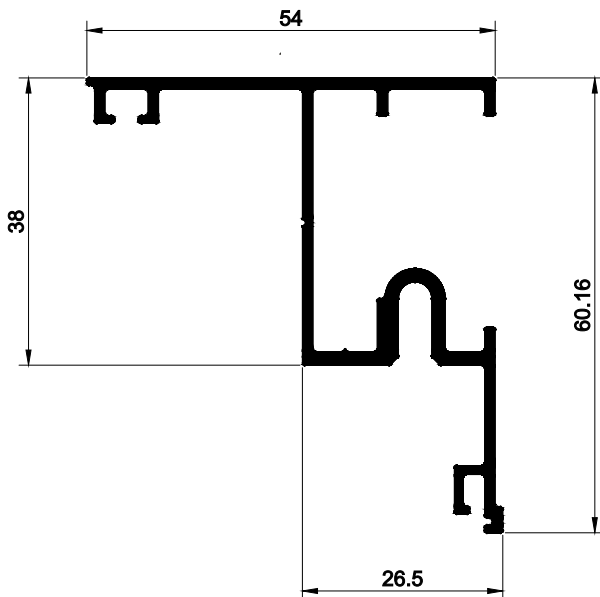

**EFA-294**  
0,785 kg/m

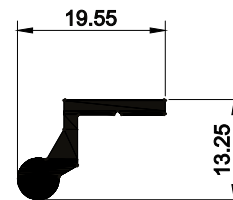

**EFA-247**  
0,192 kg/m

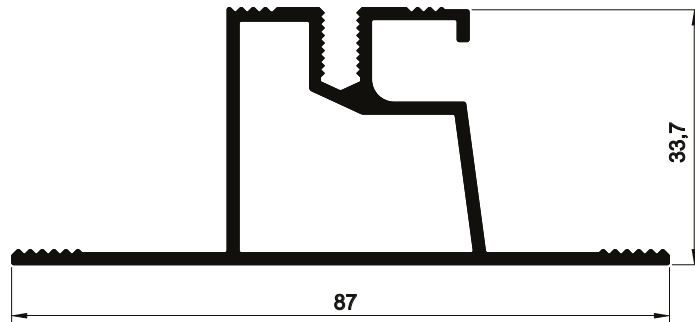

**EFA-001**  
0,916 kg/m

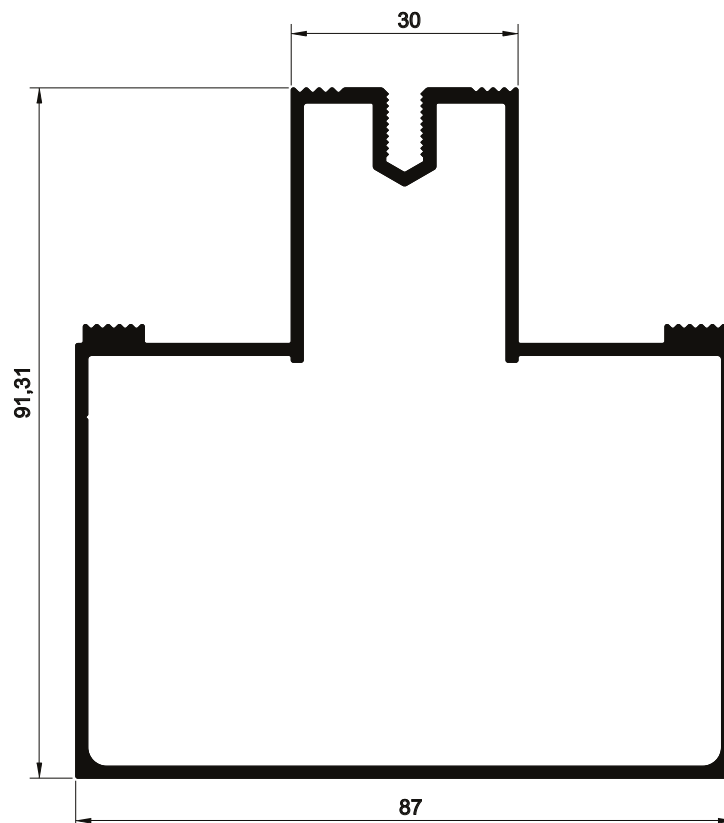

**EFA-002**  
1,740 kg/m

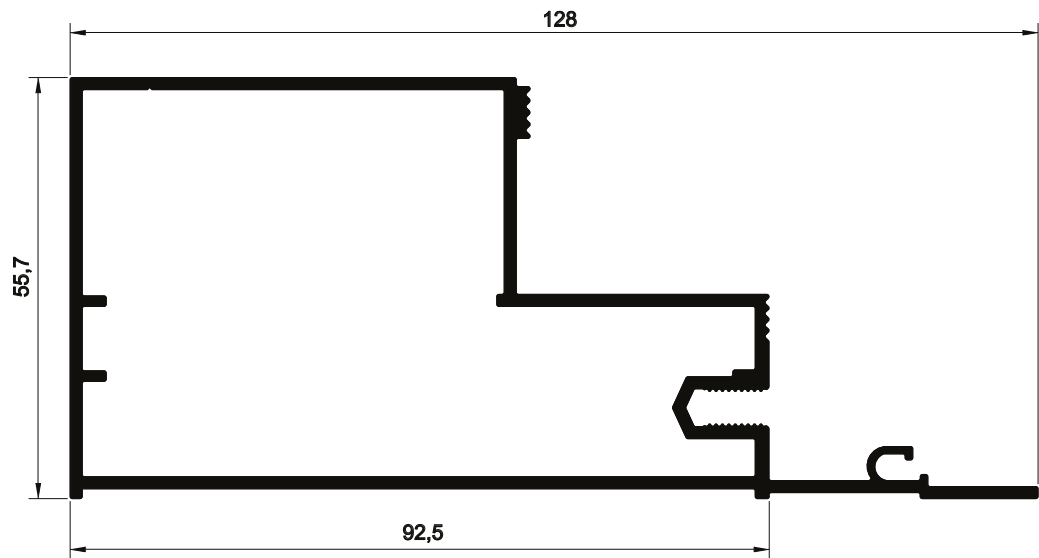

**EFA-003**  
1,605 kg/m

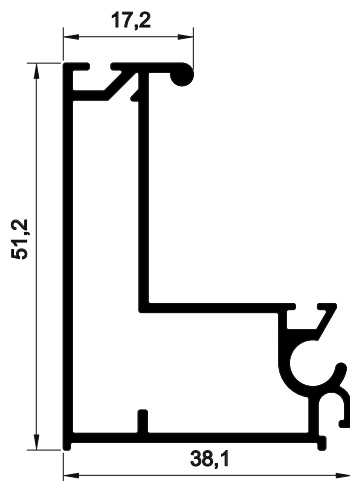

**EFA-004**  
0,702 kg/m

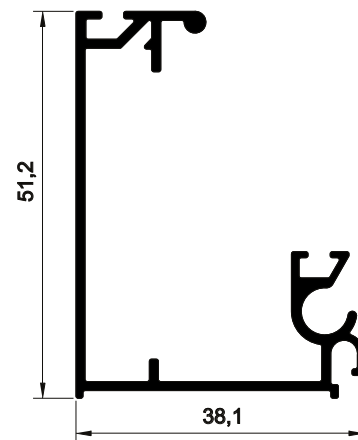

**EFA-005**  
0,524 kg/m

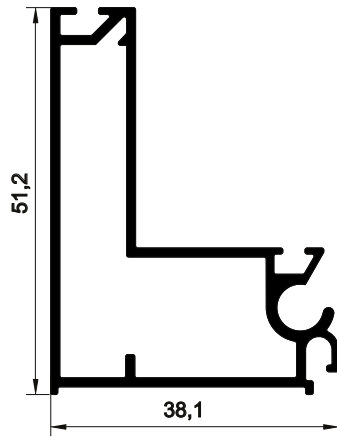

**EFA-014**  
0,635 kg/m

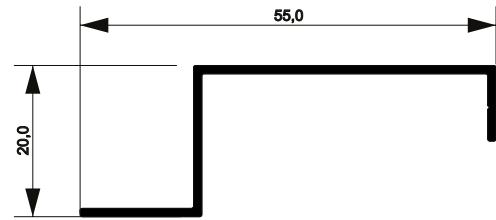

**EFA-015**  
0,246 kg/m

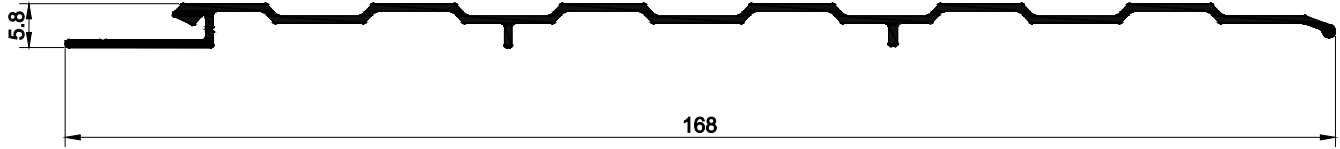

**ELB-051**  
0,533 kg/m

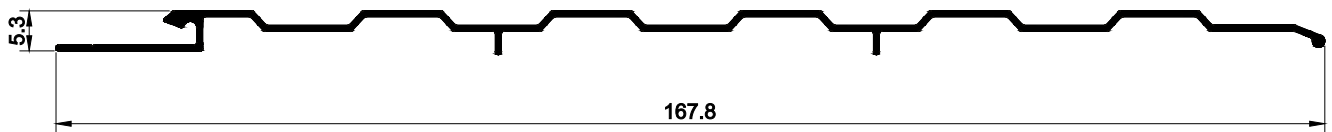

**ELB-100**  
0,478 kg/m

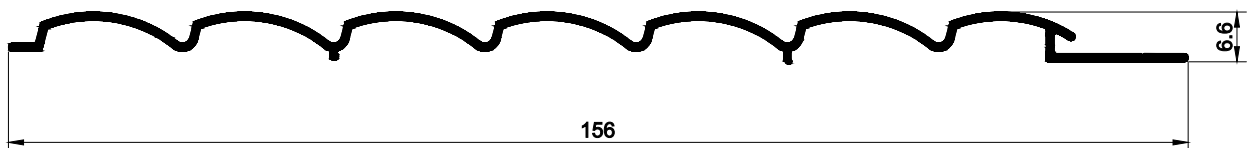

**ELB-090**  
0,553 kg/m

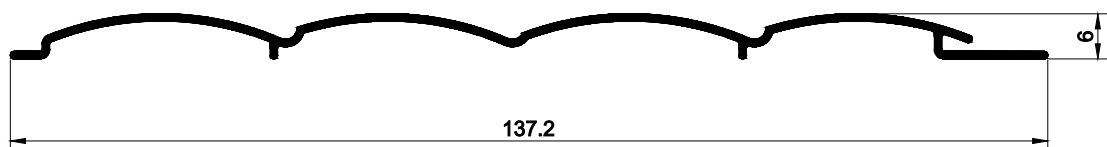

**ELB-041**  
0,418 kg/m

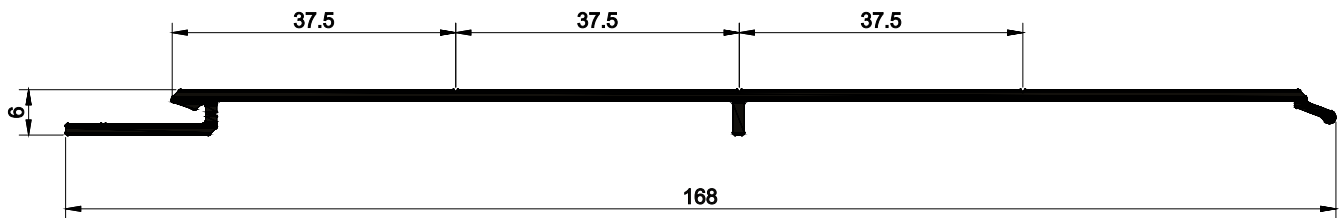

**ELB-036**  
0,742 kg/m



**ELB-037**  
0,602 kg/m

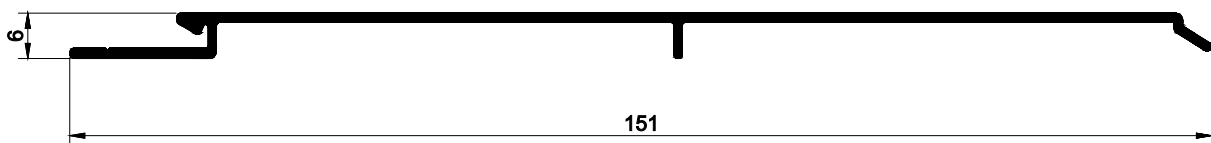

**ELB-040**  
0,556 kg/m

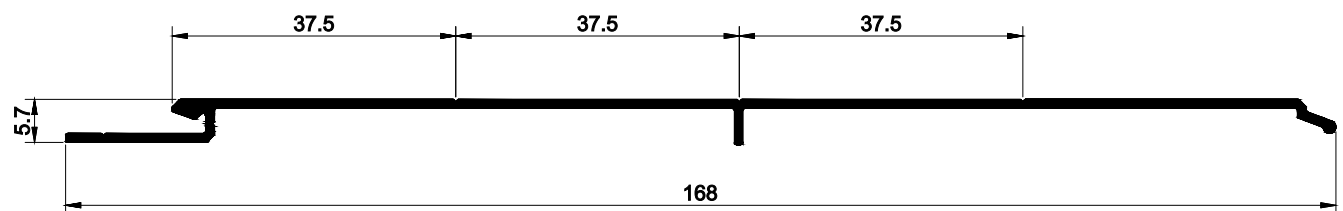

**ELB-038**  
0,602 kg/m

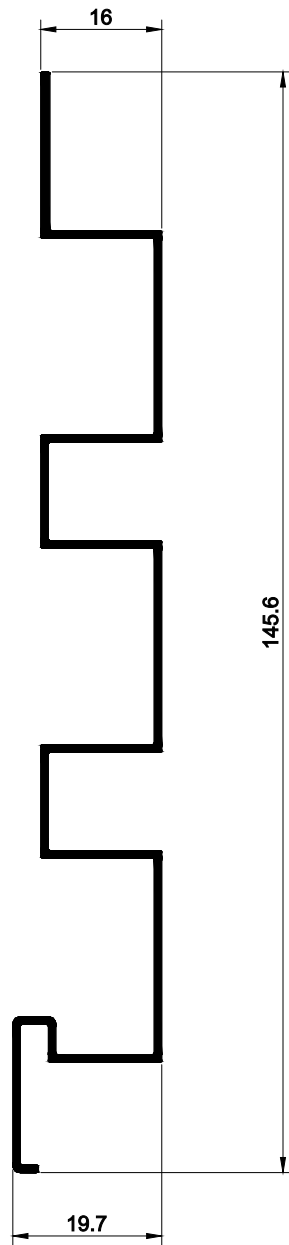

**ELB-043**  
0,691 kg/m

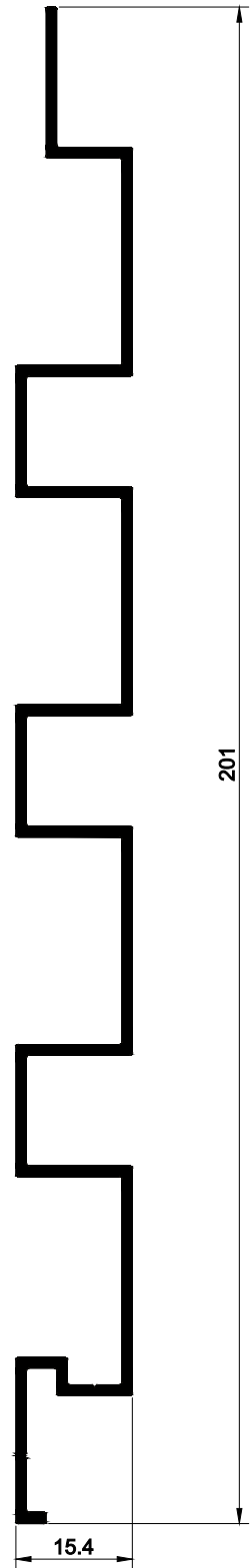

**ELB-055**  
1,210 kg/m

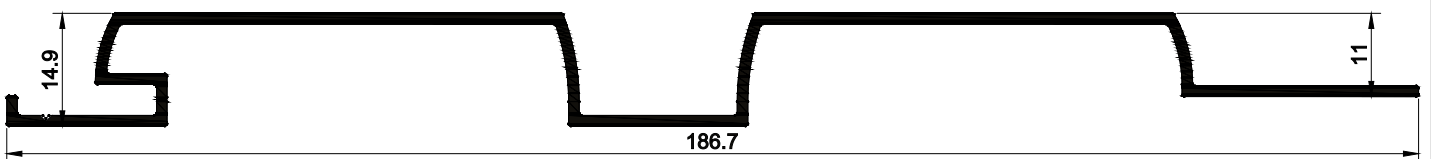

**ELB-375**  
0,940 kg/m



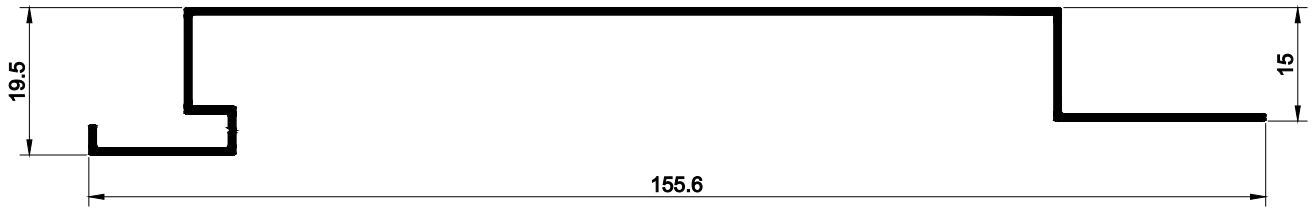

**ELB-039**  
0,548 kg/m

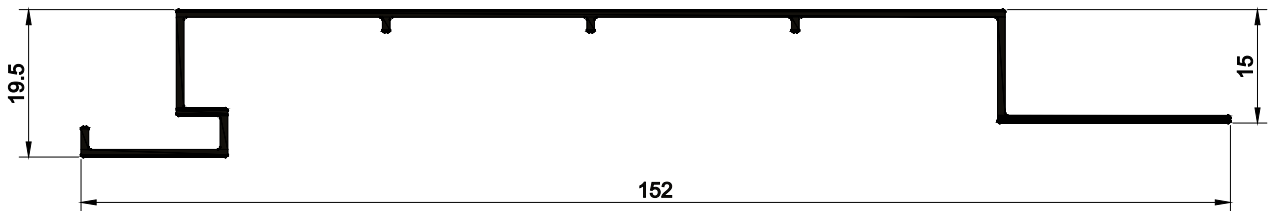

**ELB-034**  
0,555 kg/m

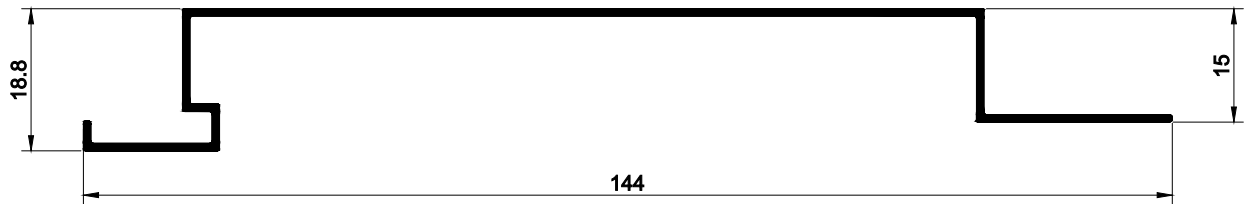

**ELB-044**  
0,505 kg/m



**ELB-091**  
0,528 kg/m

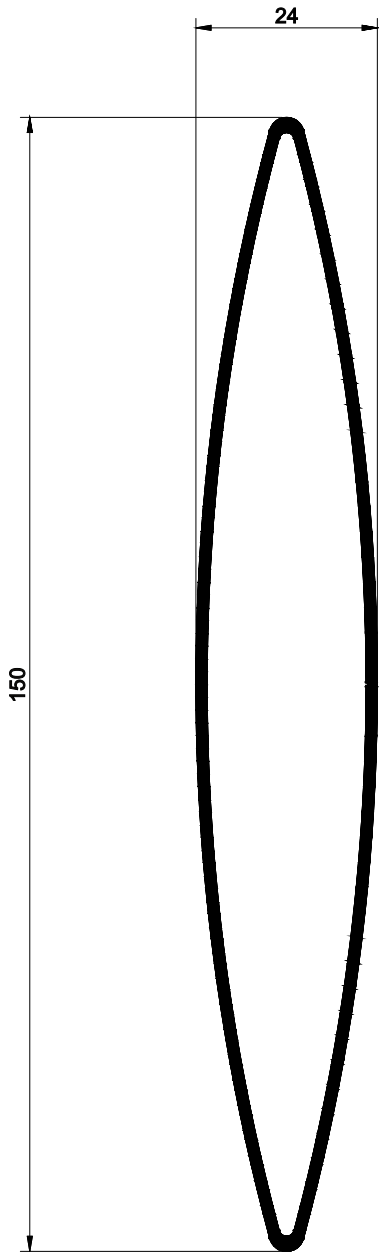

**ELB-003**  
1,238 kg/m

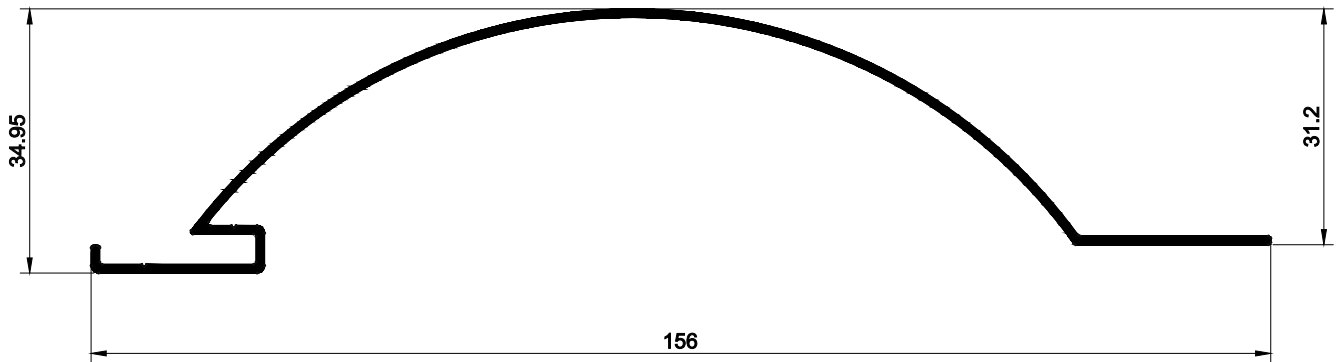

**ELB-012**  
0,617 kg/m

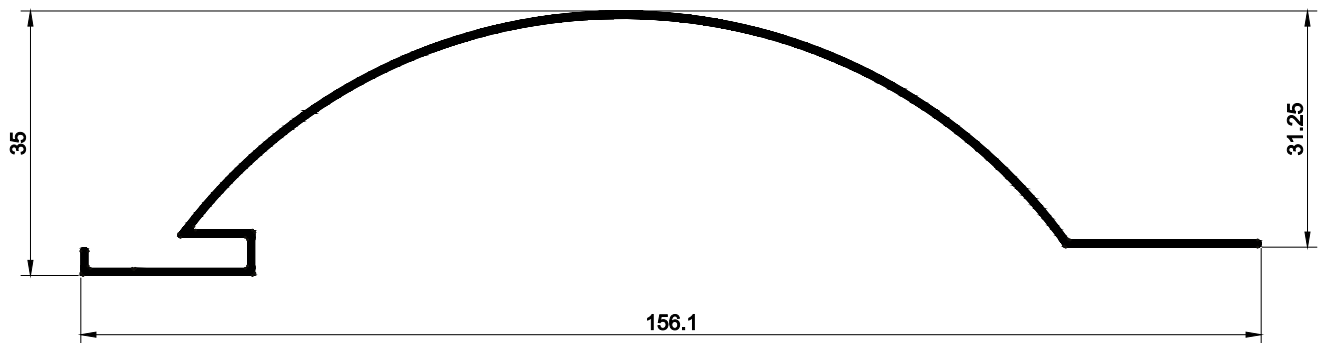

**ELB-035**  
0,535 kg/m

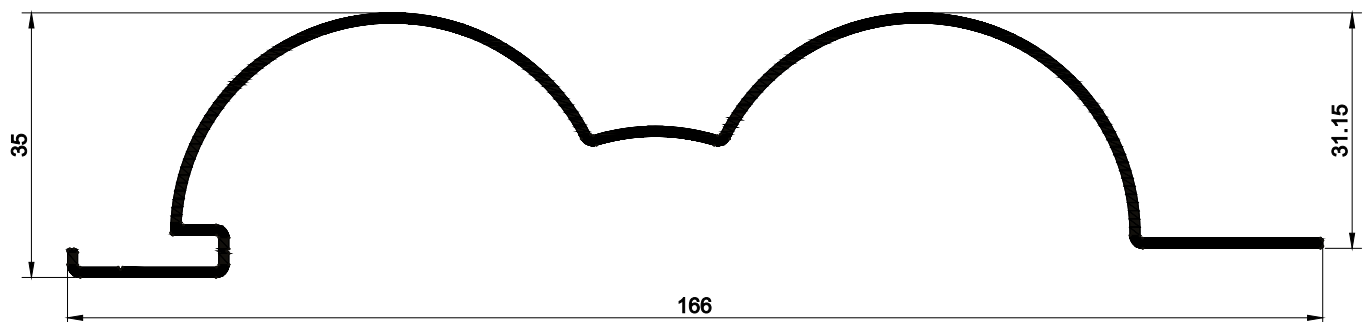

**ELB-004**  
0,843 kg/m

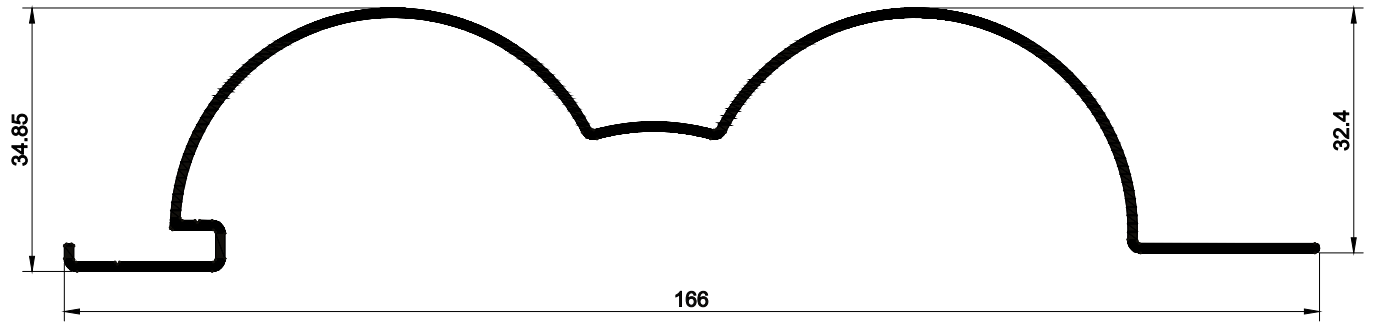

**ELB-014**  
0,780 kg/m

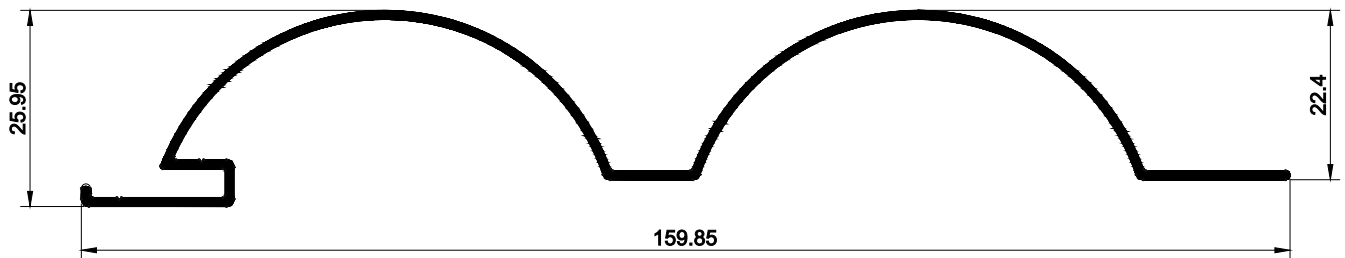

**ELB-028**  
0,710 kg/m

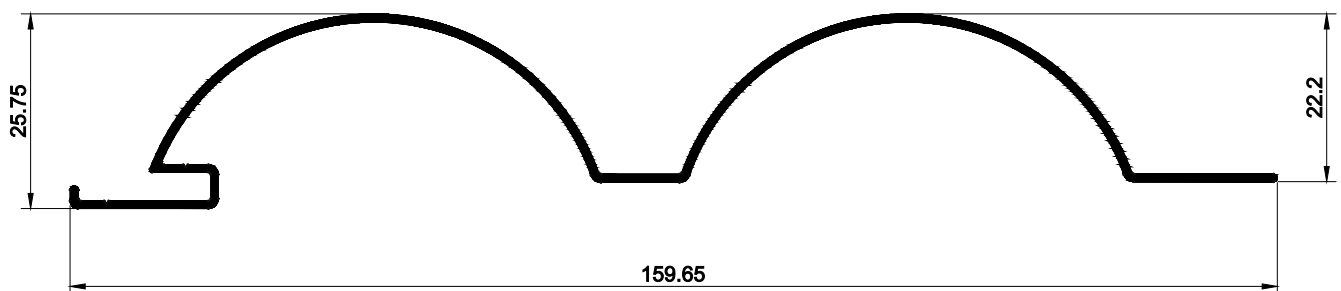

**ELB-048**  
0,631 kg/m

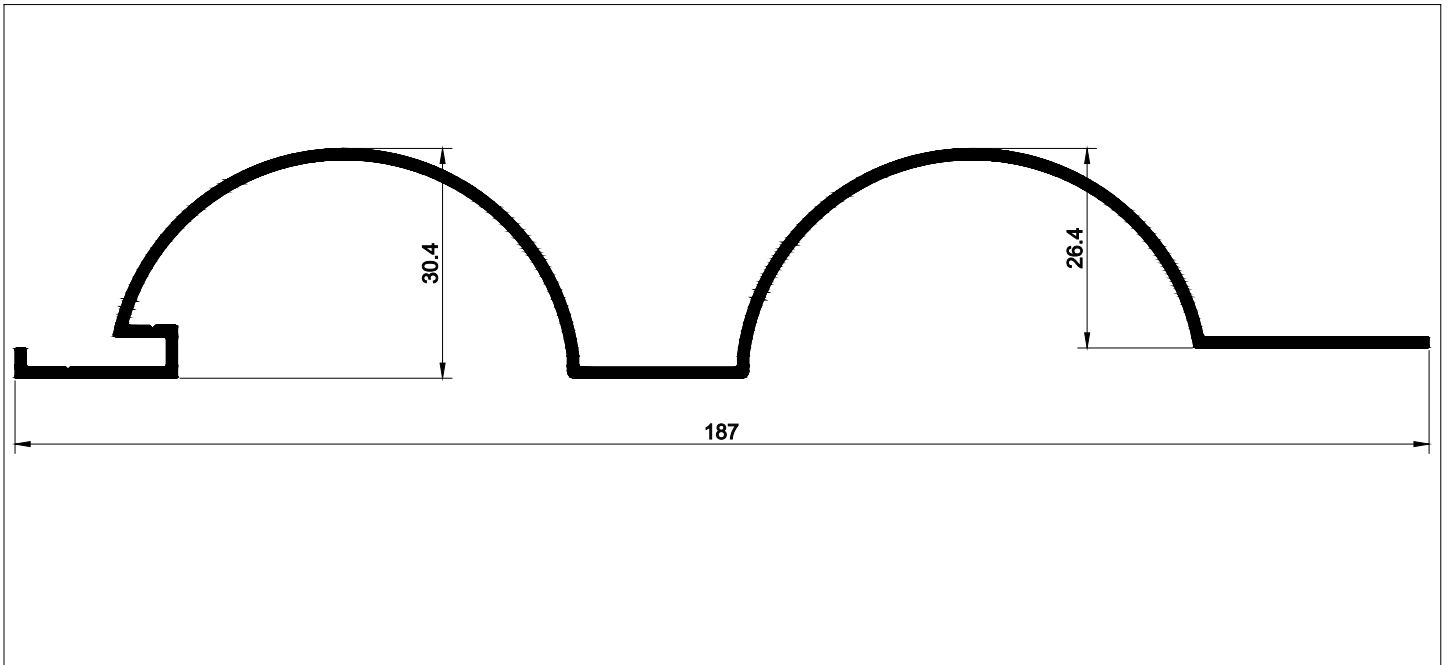

**ELB-187**  
1,072 kg/m

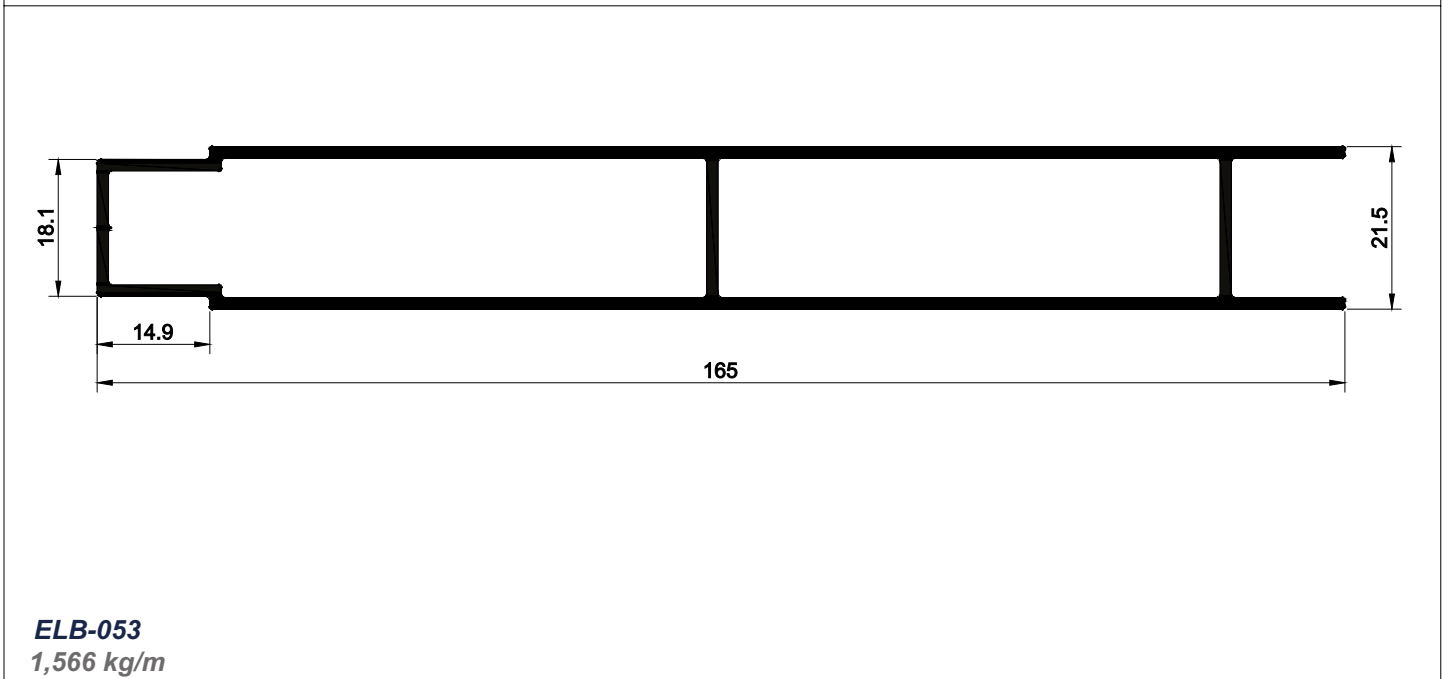

**ELB-053**  
1,566 kg/m

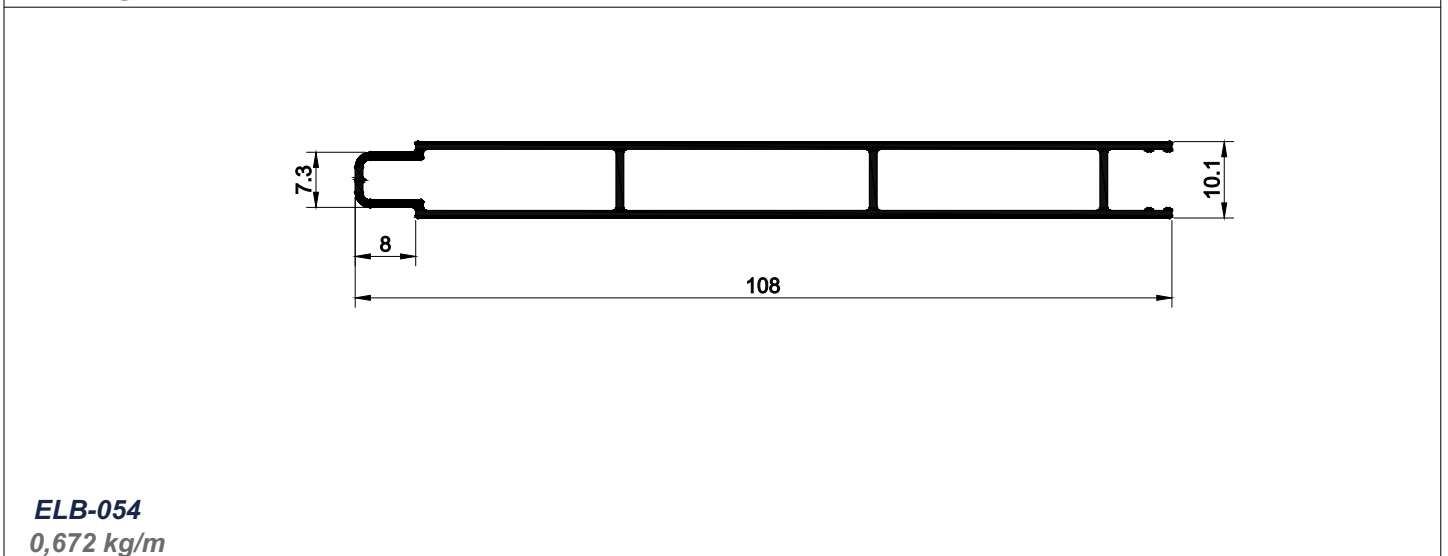

**ELB-054**  
0,672 kg/m

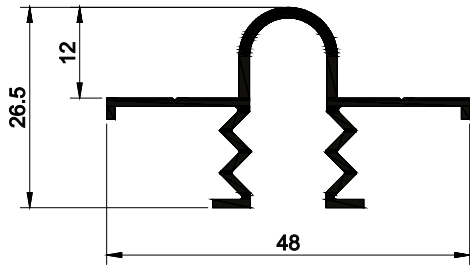

**EPO-021**  
0,365 kg/m

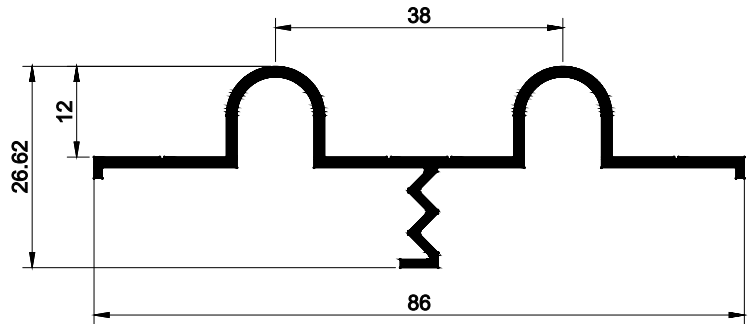

**EPO-022**  
0,543 kg/m

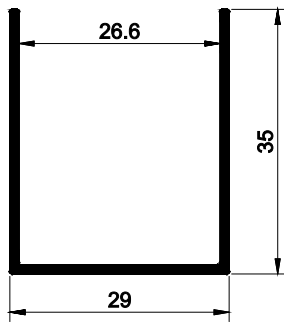

**EPU-639**  
0,314 kg/m

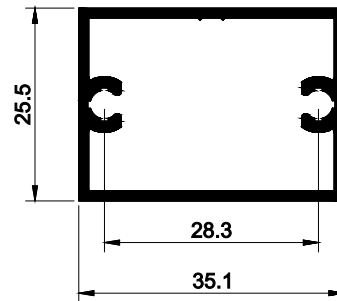

**EPO-055**  
0,505 kg/m

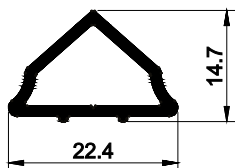

**EPO-081**  
0,209 kg/m

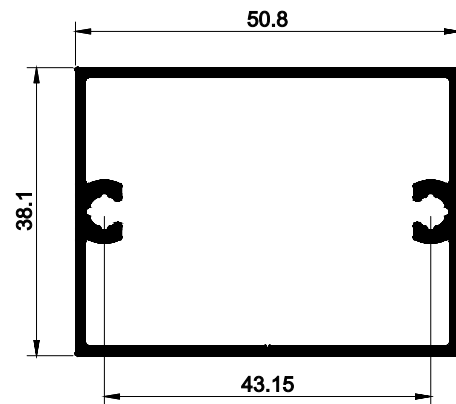

**EPO-103**  
0,729 kg/m

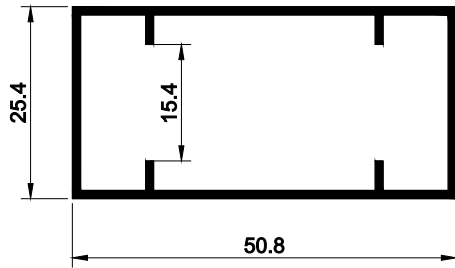

**EPO-079**  
0,484 kg/m

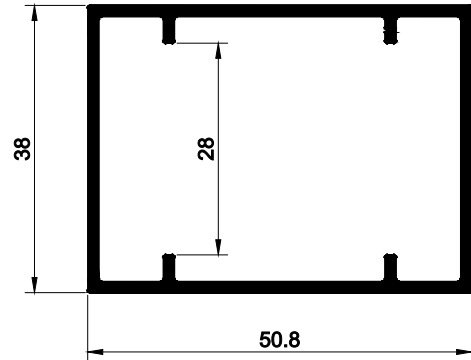

**EPO-078**  
0,754 kg/m

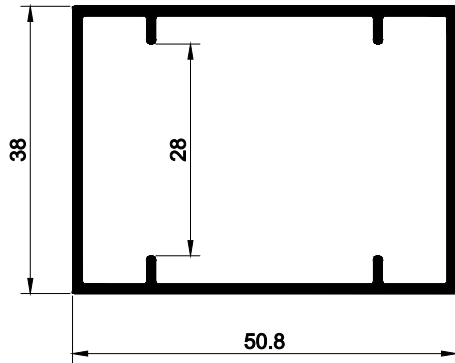

**EPO-078L**  
0,654 kg/m

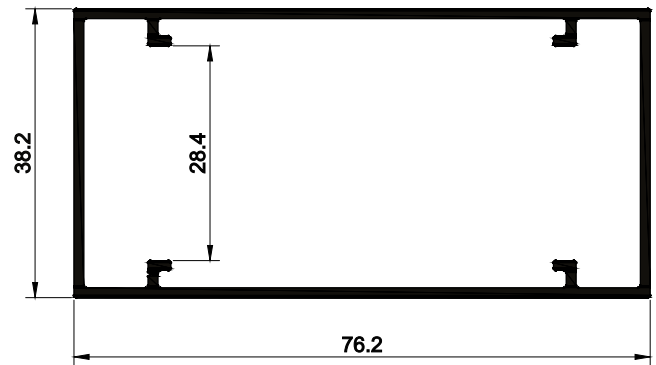

**EPO-069**  
0,862 kg/m

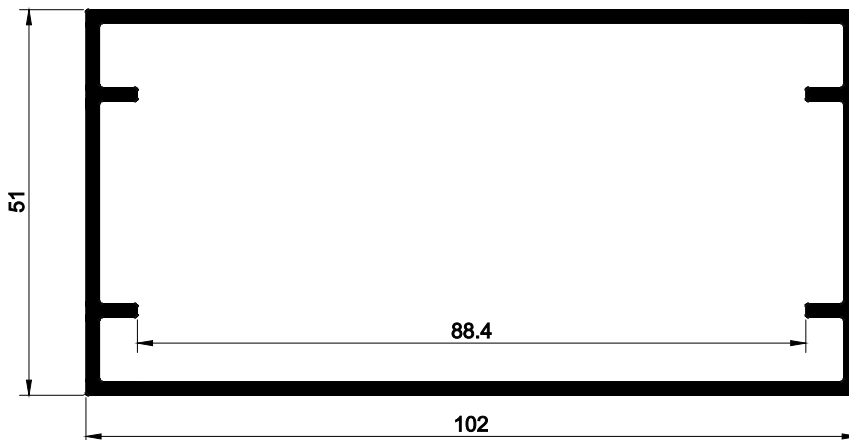

**EPO-080**  
1,555 kg/m

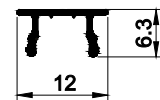

**EVT-053**  
0,047 kg/m

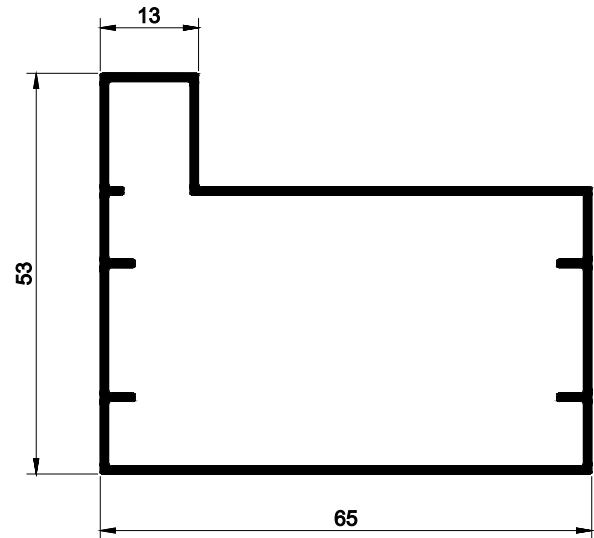
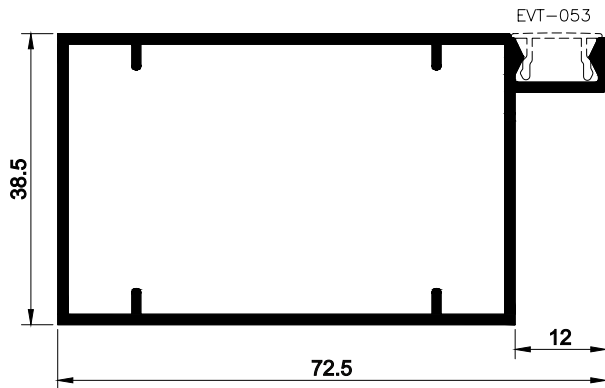

**EPO-778**  
0,847kg/m

**EPO-501**  
0,738kg/m

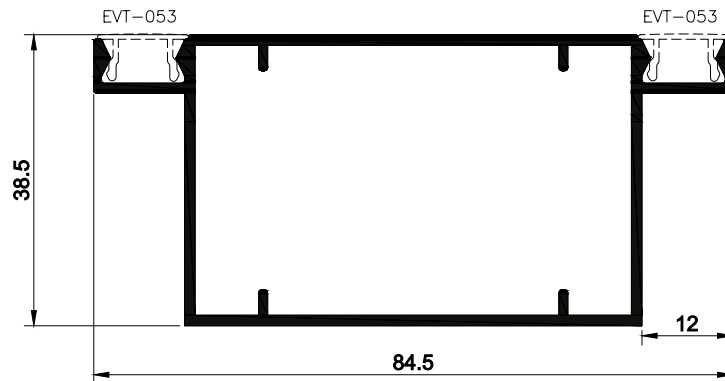

**EPO-777**  
0,921kg/m

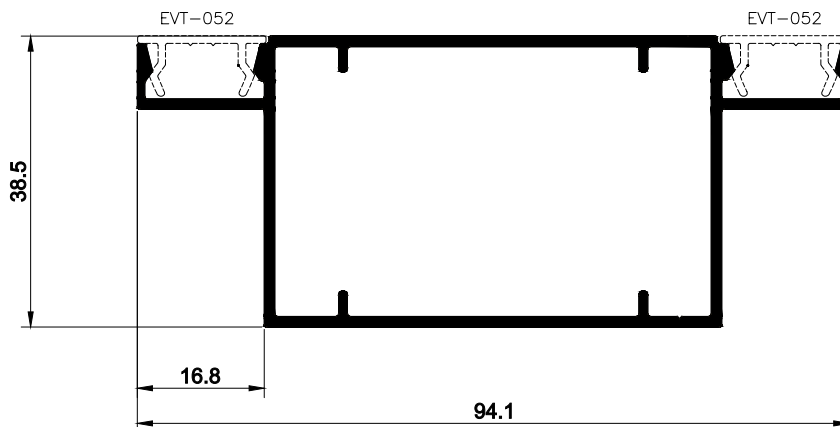

**EPO-780**  
0,971kg/m



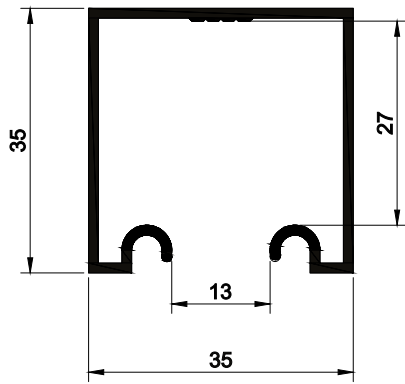

**EPO-266**  
0,480 kg/m

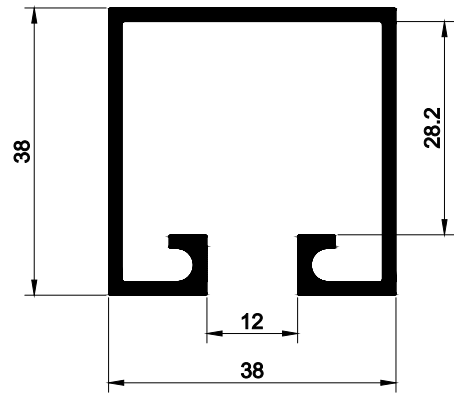

**EPO-990**  
0,751 kg/m

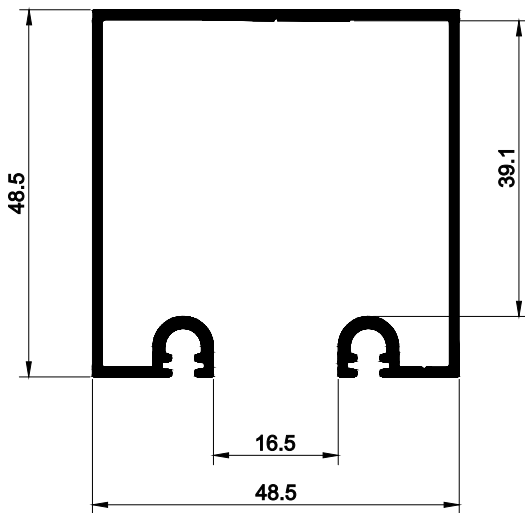

**EVT-002**  
0,723 kg/m

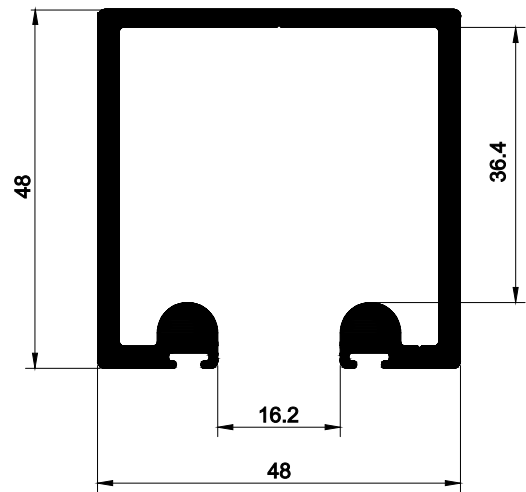

**EVT-006**  
1,458 kg/m

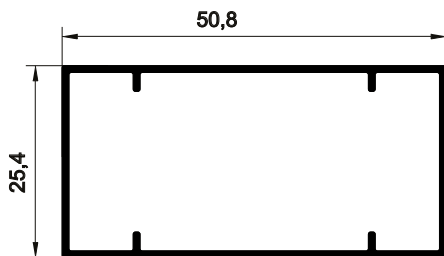

**EPO-079L**  
0,387 kg/m

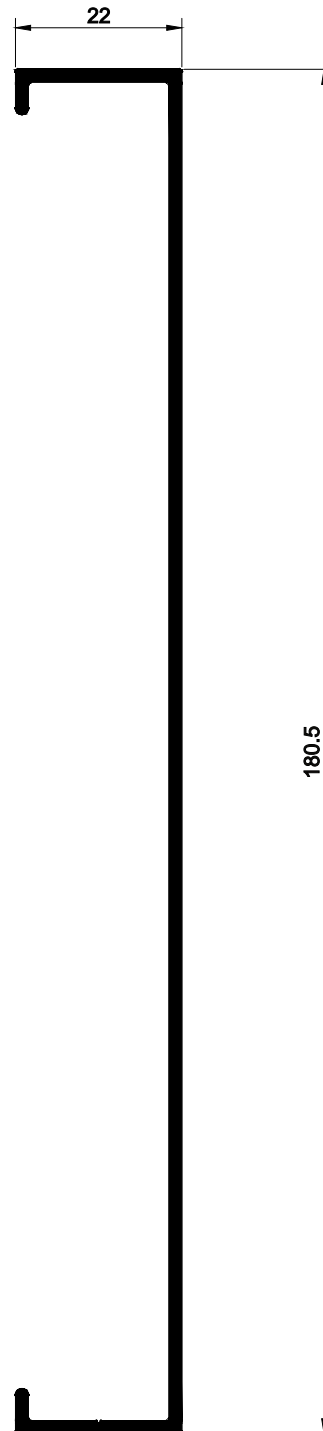

**EPO-110**  
1,057 kg/m

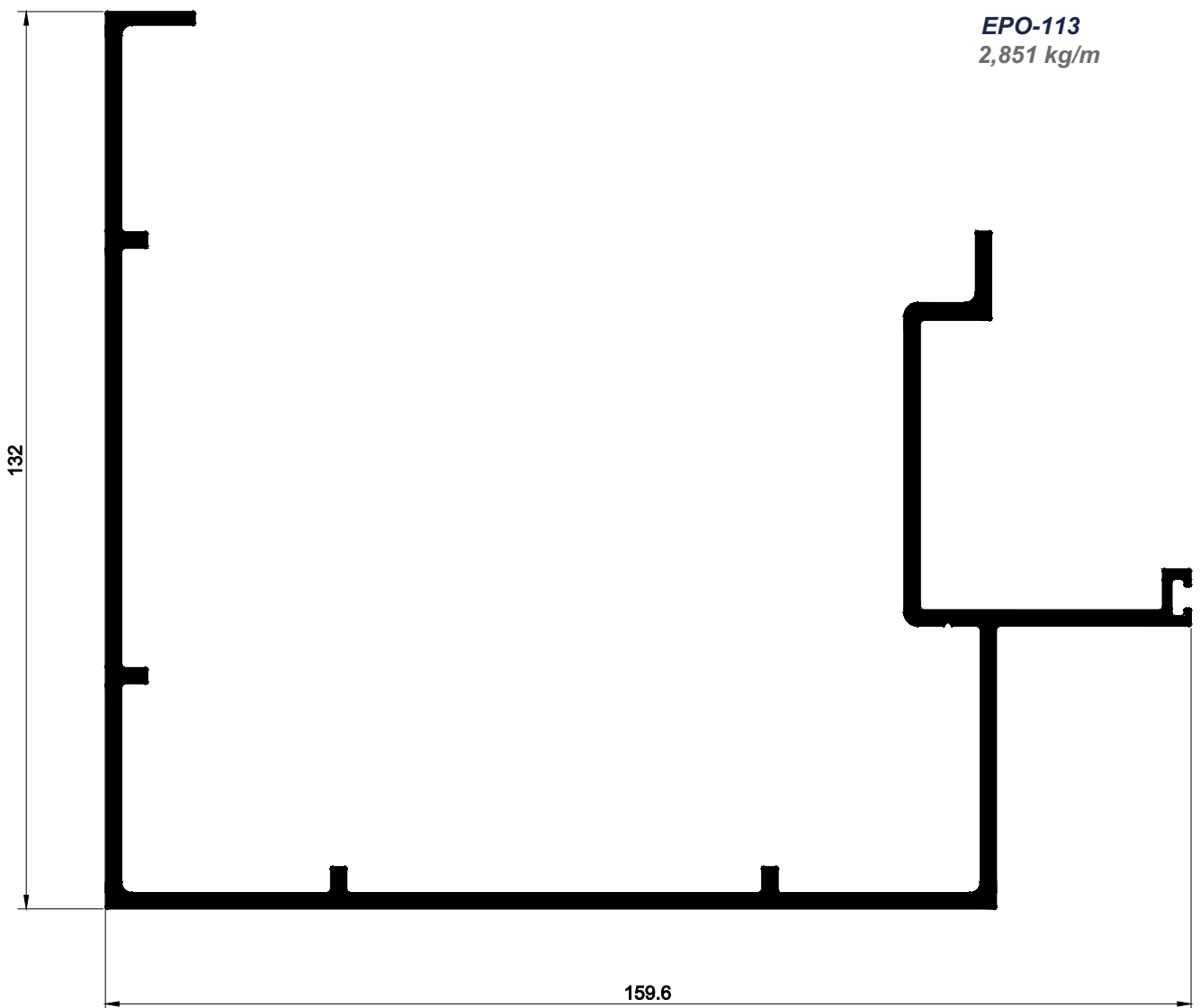
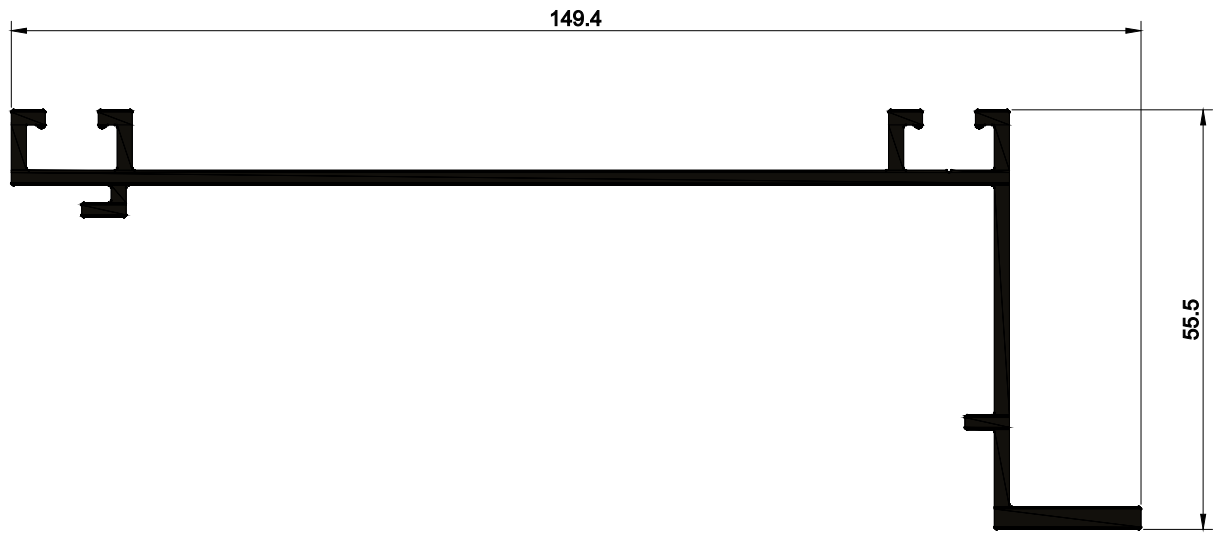

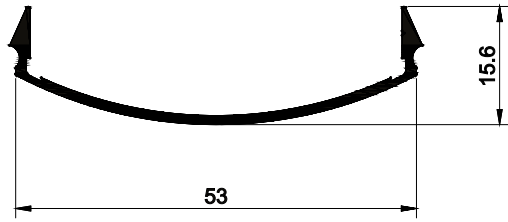

**EGR-074**  
0,240 kg/m

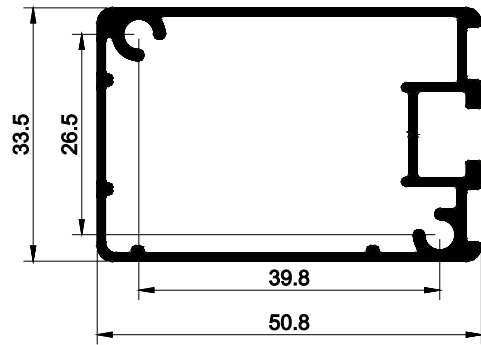

**EGR-077**  
0,688 kg/m

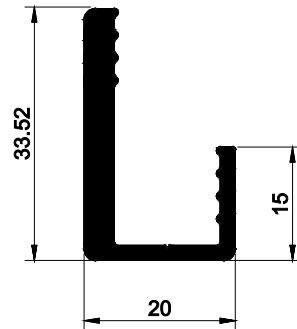

**EGR-075**  
0,523 kg/m

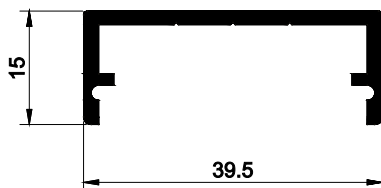

**EGR-496**  
0,341 kg/m

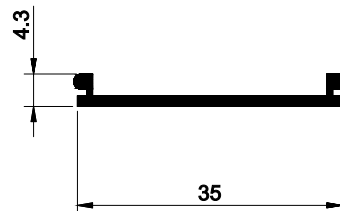

**EGR-495**  
0,161 kg/m

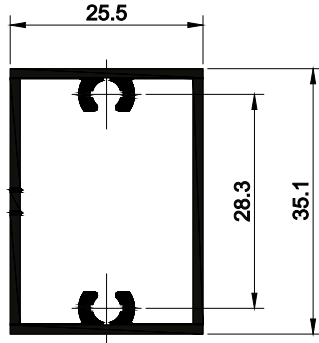

**EGR-001**  
0,506 kg/m

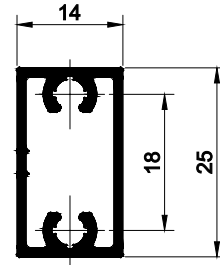

**EGR-002**  
0,321 kg/m

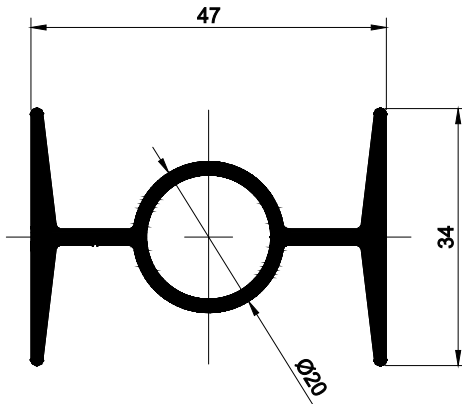

**EGR-100**  
0,860 kg/m

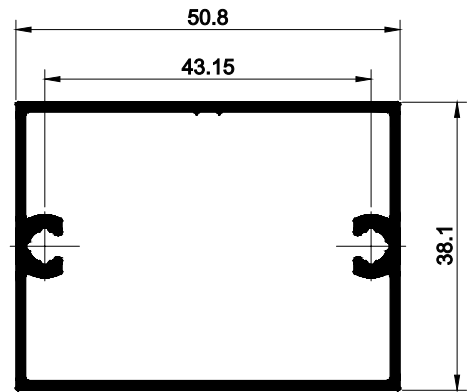

**EPO-103**  
0,729 kg/m

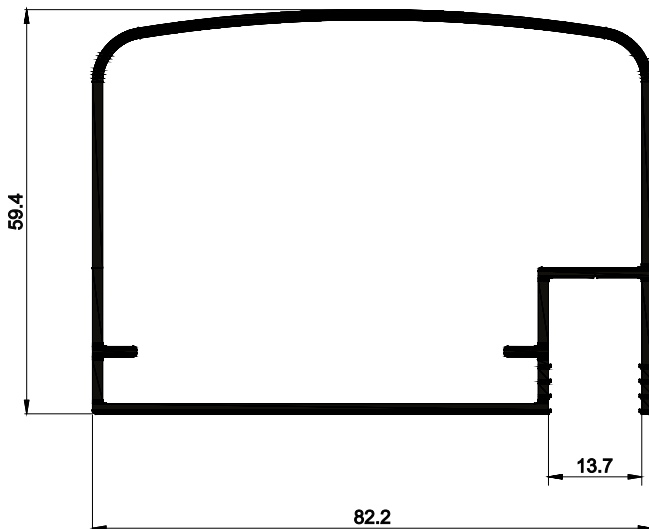

**EGR-085**  
1,206 kg/m

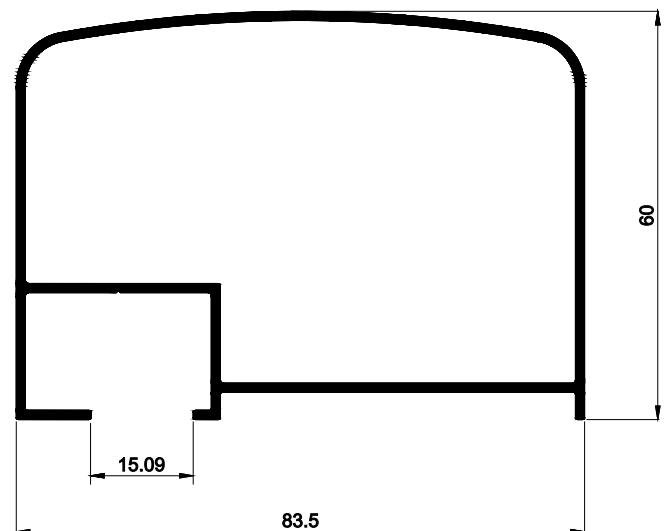

**EGR-500**  
1,100 kg/m

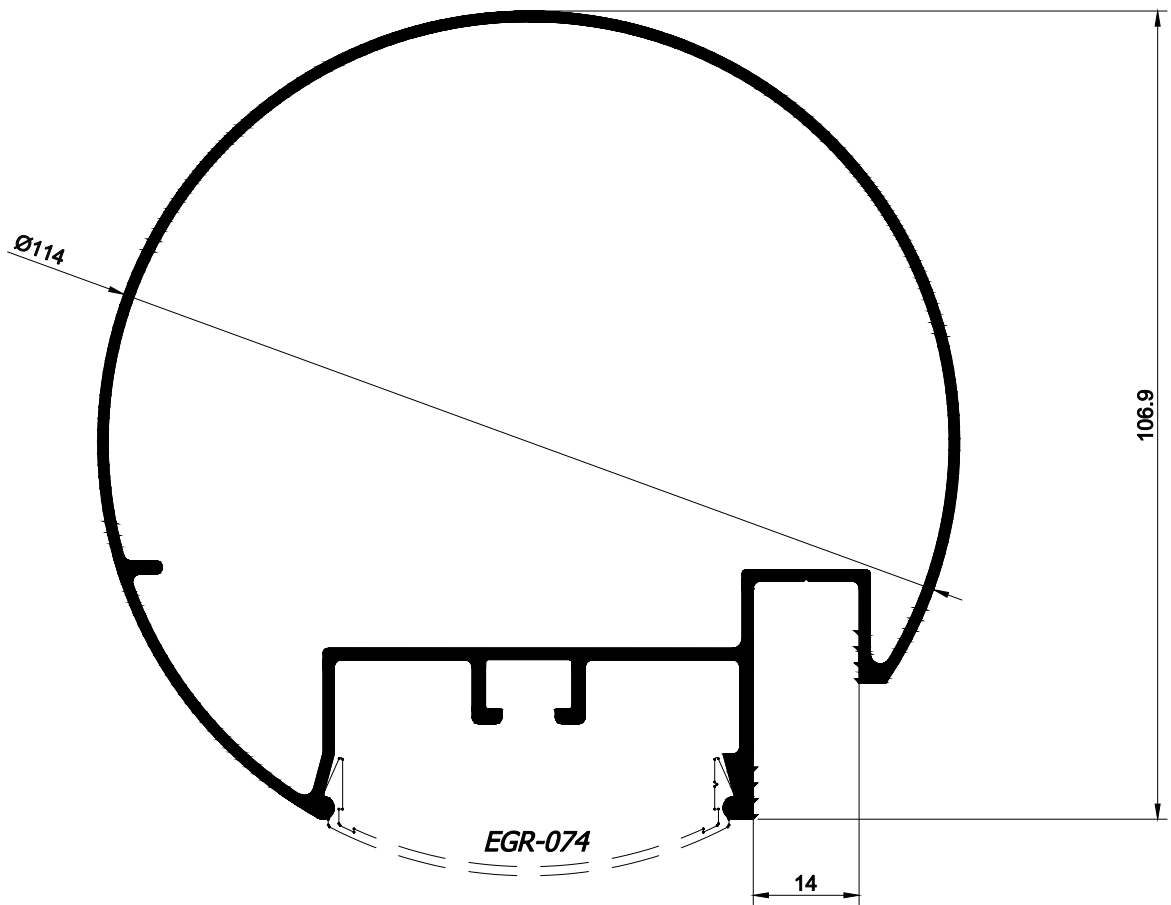

**EGR-143**  
1,794 kg/m

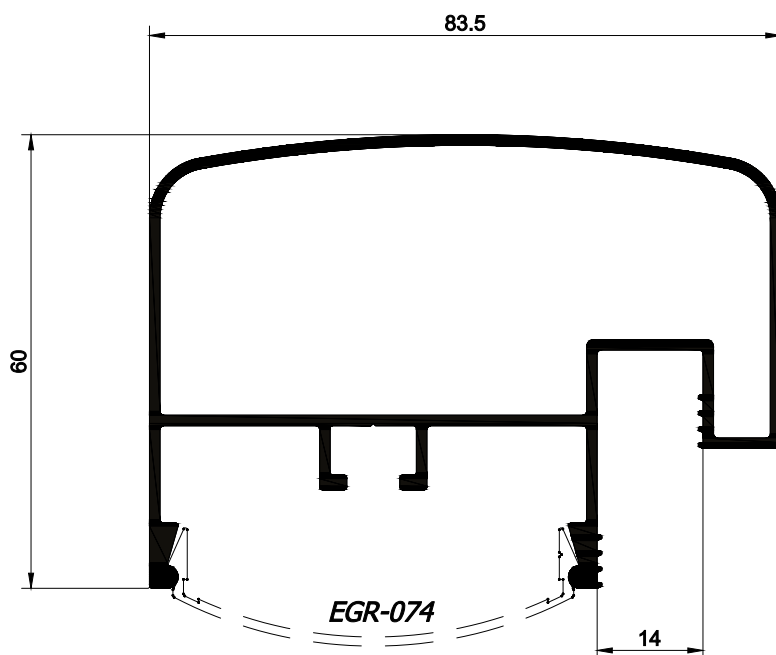

**EGR-083**  
1,301 kg/m

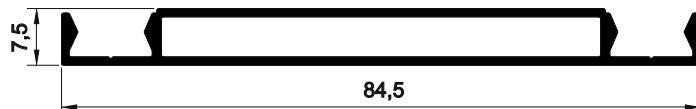

**EFA-006**  
0,525 kg/m

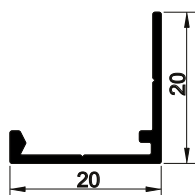

**EFA-007**  
0,138 kg/m

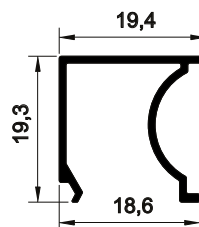

**EFA-008**  
0,154 kg/m

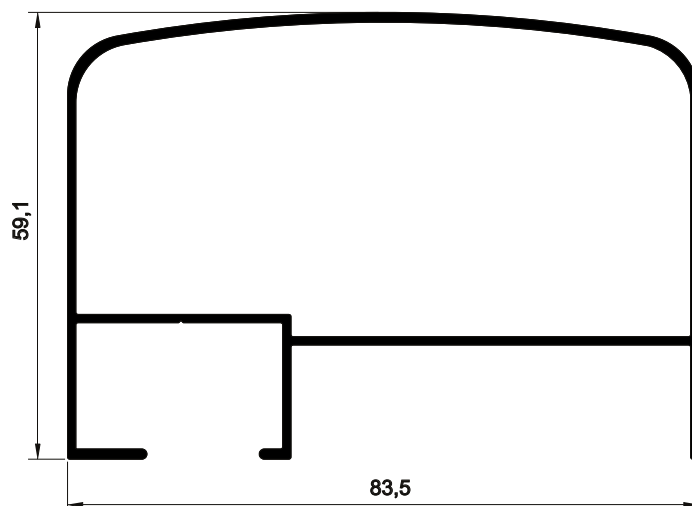

**EFA-009**  
0,939 kg/m

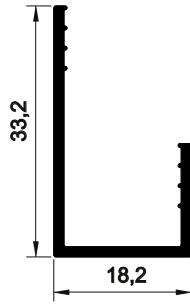

**EFA-010**  
0,237 kg/m

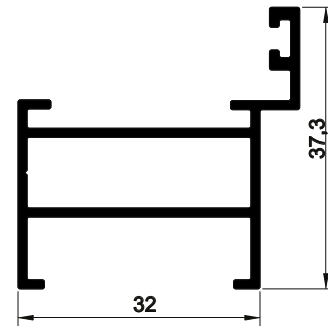

**EFA-011**  
0,477 kg/m



**CORRIMÃO**

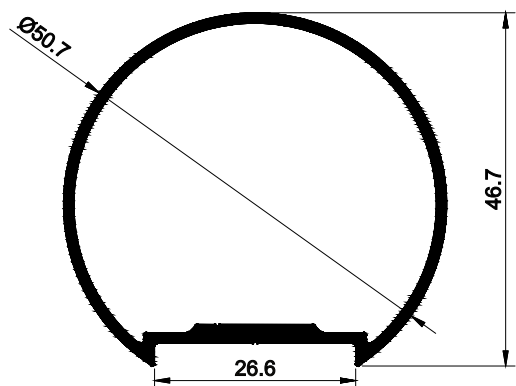

**ECR-097**  
0,650 kg/m

**CORRIMÃO**

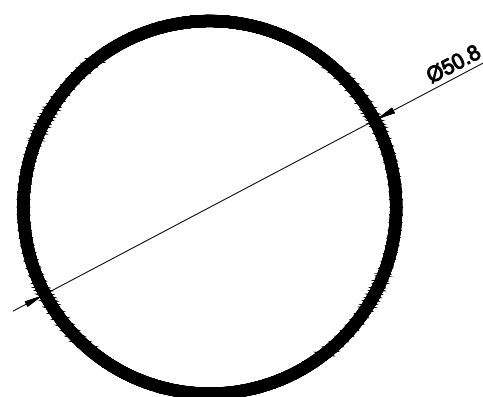

**ETR-025**  
0,631 kg/m

**CORRIMÃO**

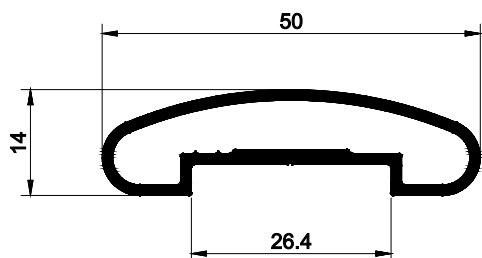

**ECR-095**  
0,463 kg/m

**BASE CORRIMÃO**

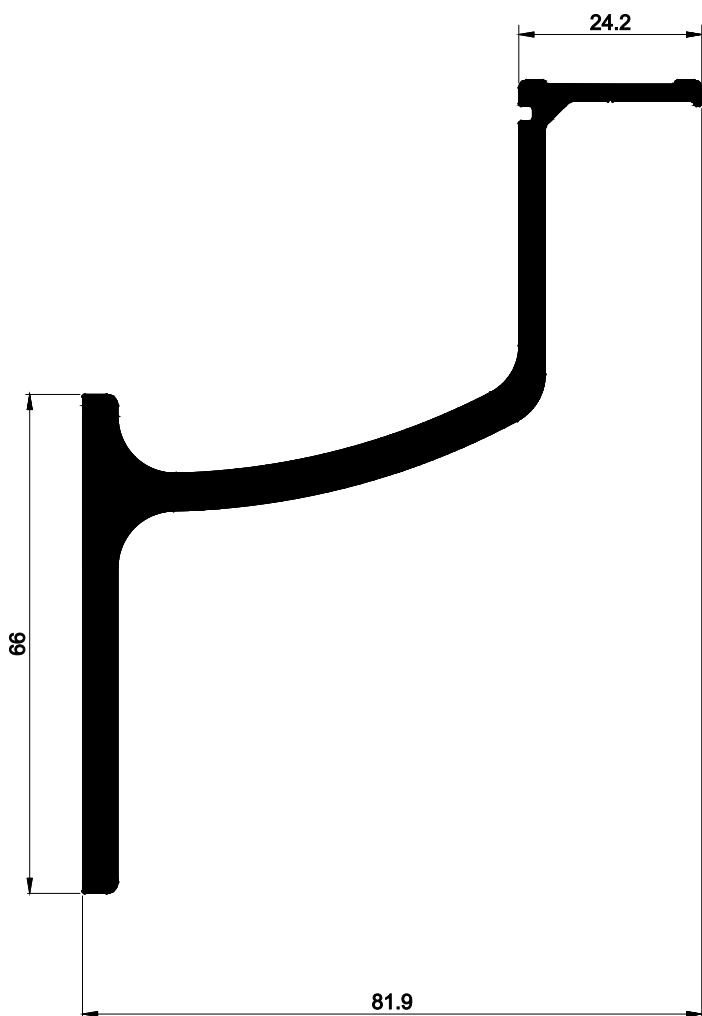

**ECR-021**  
2,206 kg/m

**PERFIL QUADRO**

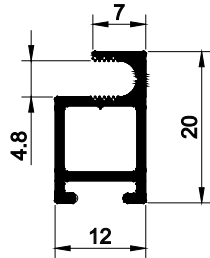

**E25-547**  
0,206 Kg/m

**PERFIL QUADRO**

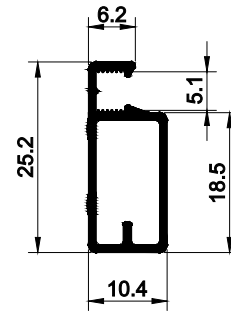

**E25-551**  
0,196 kg/m

**PERFIL QUADRO**

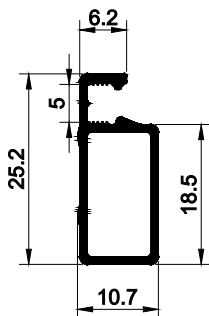

**E25-600**  
0,190 Kg/m

**PERFIL QUADRO**

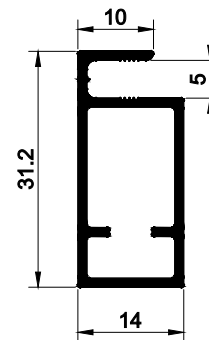

**E25-601**  
0,306 kg/m

**PERFIL QUADRO**

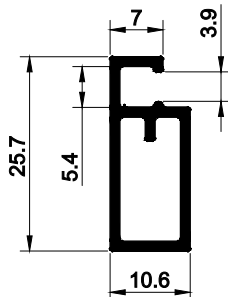

**E25-602**  
0,249 Kg/m

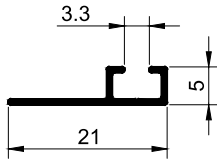

**EMV-006**  
0,065 kg/m

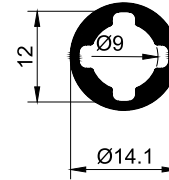

**EPS-2304**  
0,200 kg/m

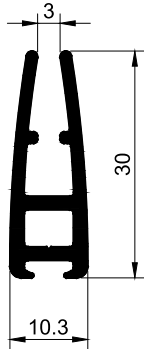

**EPS-4217**  
0,344 kg/m

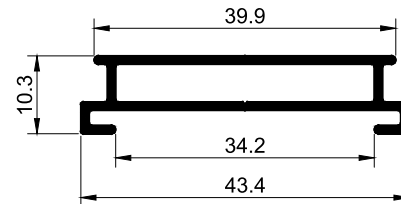

**EPS-1524**  
0,317 kg/m

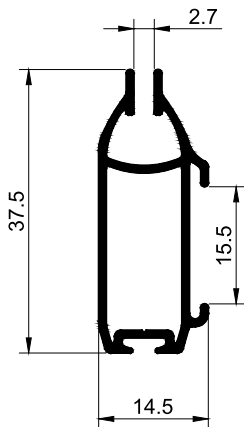

**EPS-0448**  
0,309 kg/m

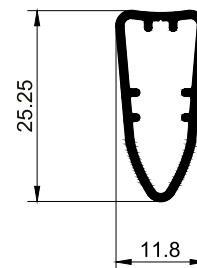

**EPS-2303**  
0,182 kg/m

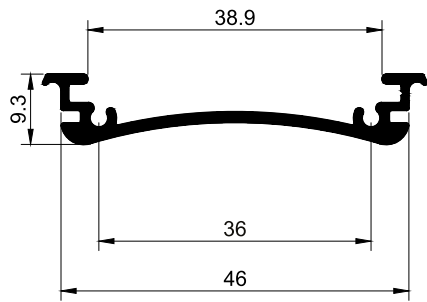

**EPS-5905**  
0,303 Kg/m

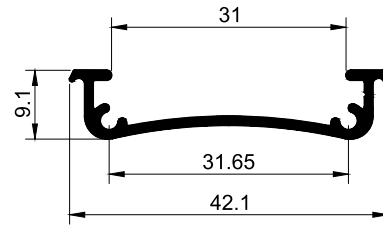

**EPS-5904**  
0,219 Kg/m

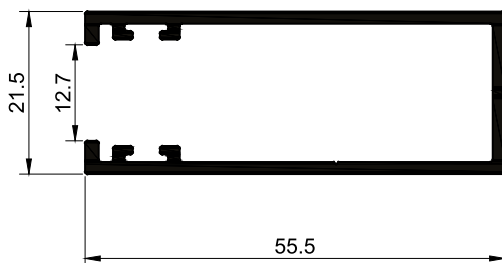

**EPS-1304**  
0,634 Kg/m

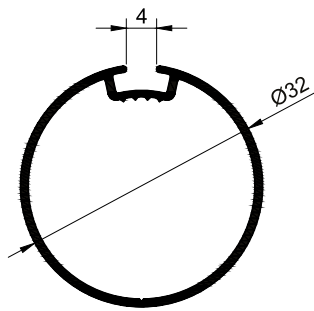

**EPS-2167**  
0,282 kg/m

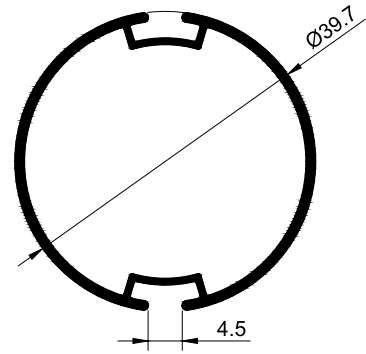

**EPS-1221**  
0,425 kg/m

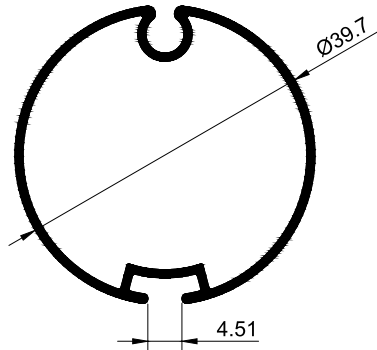

**EPS-816**  
0,434 kg/m

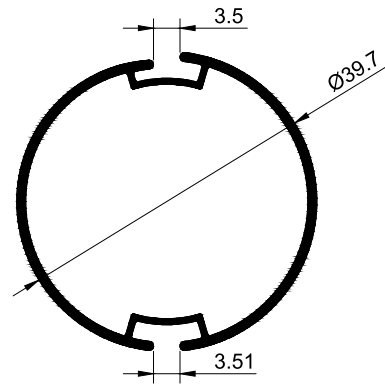

**EPS-5793**  
0,427 kg/m

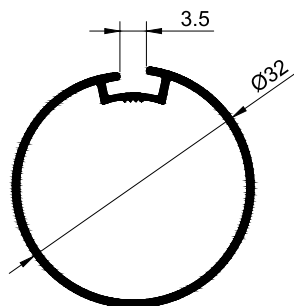

**EPS-5824**  
0,285 kg/m

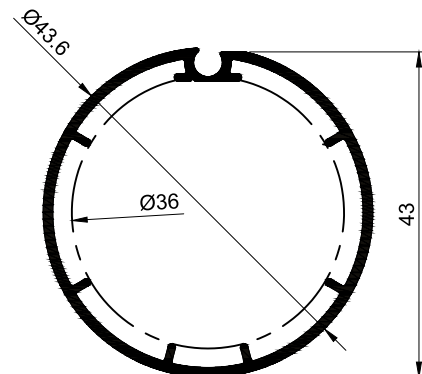

**EPS-1740**  
0,523 kg/m

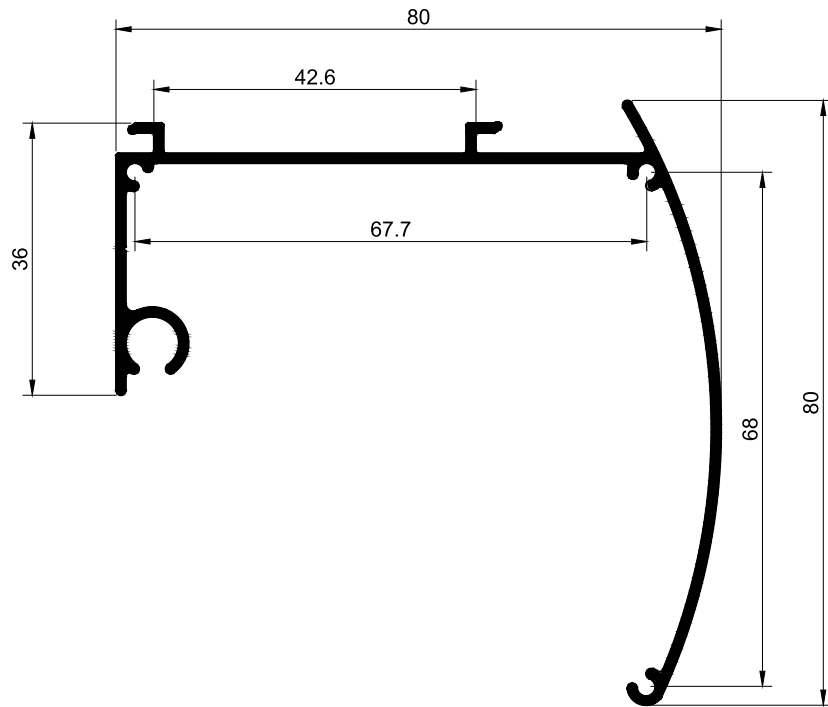

**EPS-4297**  
0,808 kg/m

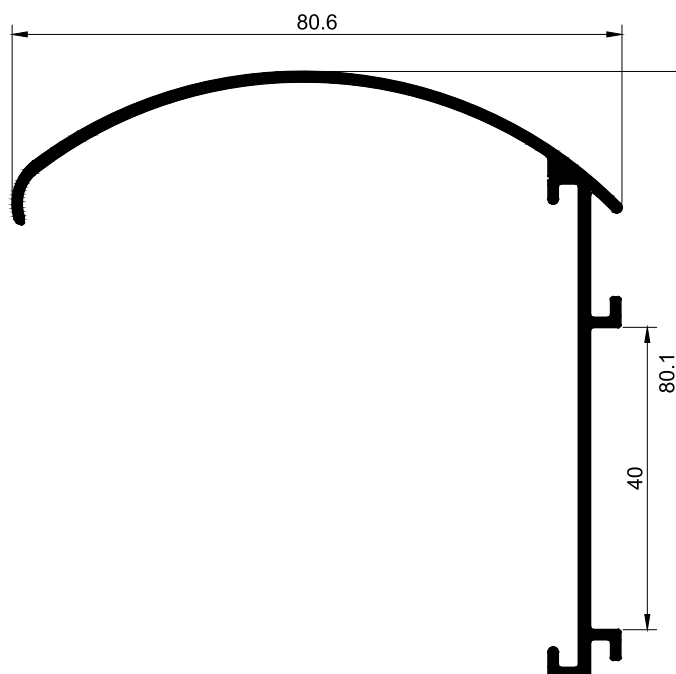

**EPS-1720**  
0,729 kg/m

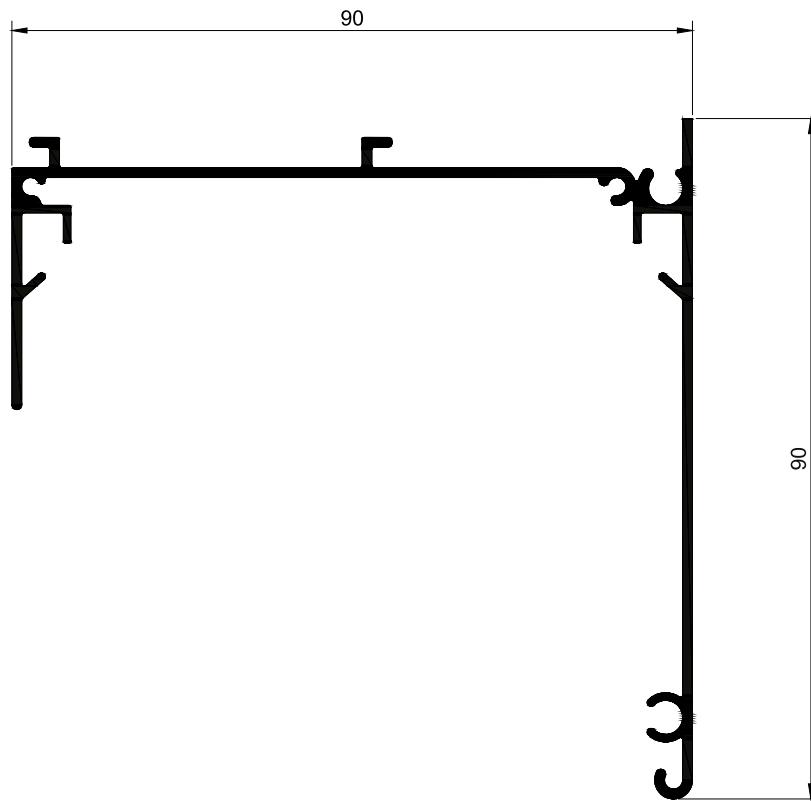

**EPS-272**  
0,947 kg/m

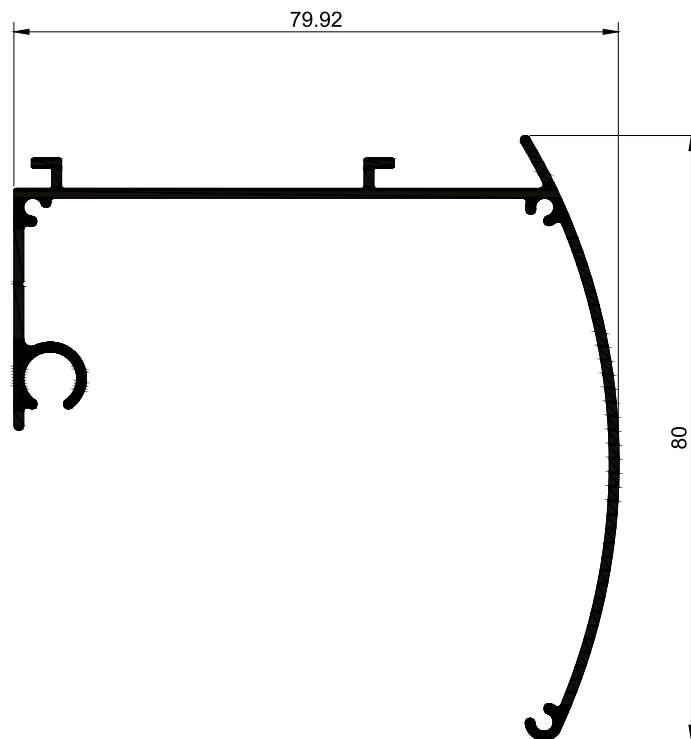

**EPS-4297**  
0,807 kg/m

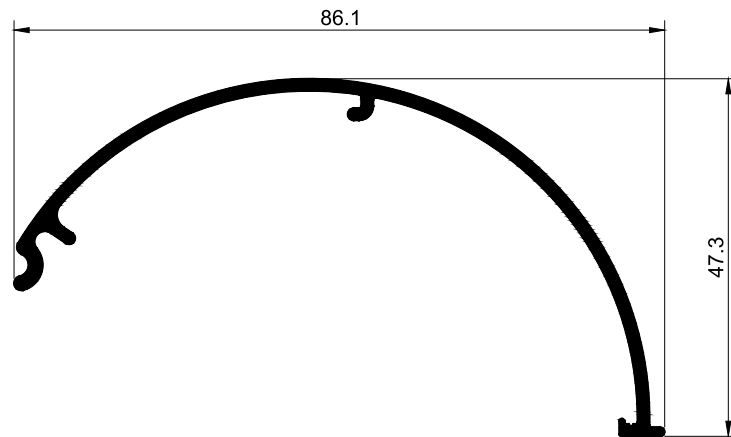

**EPS-2307**  
0,604 kg/m

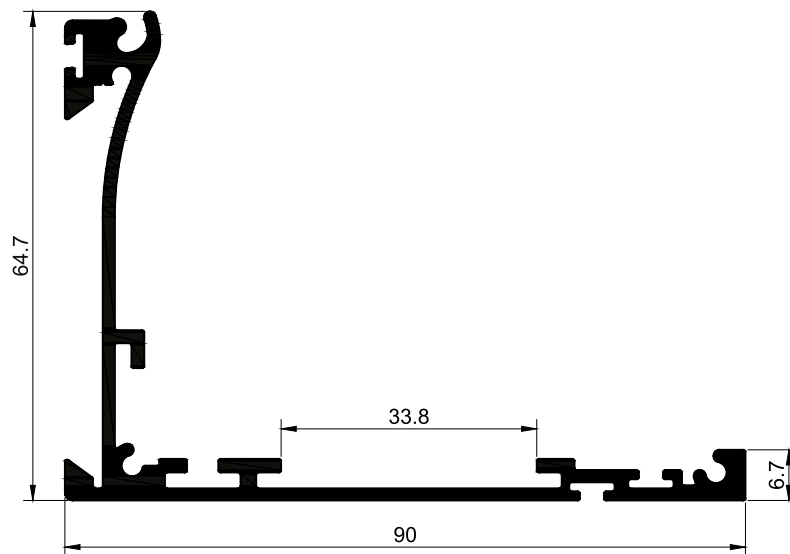

**EPS-2306**  
1,170 kg/m

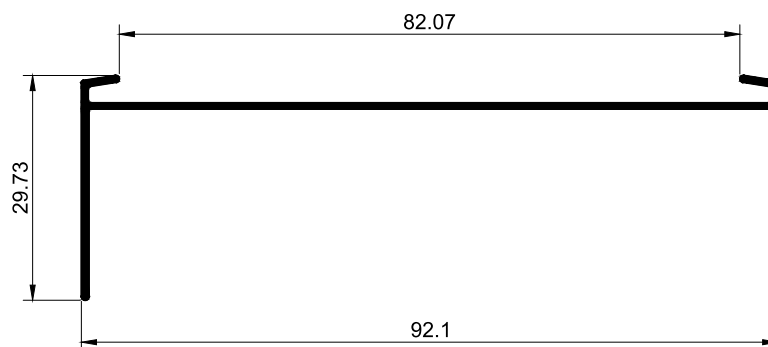

**EPS-0190**  
0,296 kg/m



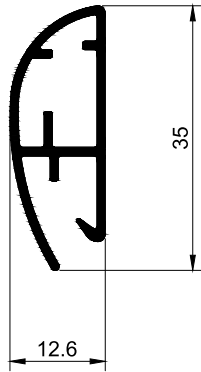

**EPS-6354**  
0,293 kg/m

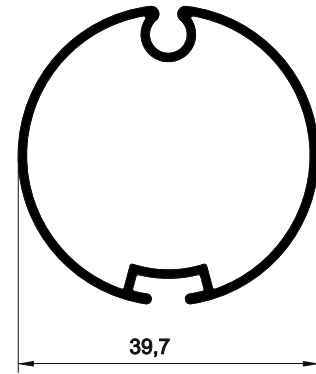

**EPS-0816**  
0,435 kg/m



**EPS-0359**  
0,041 kg/m



**EPS-0654**  
0,096 kg/m

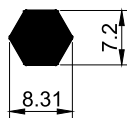

**EPS-1487**  
0,122 kg/m

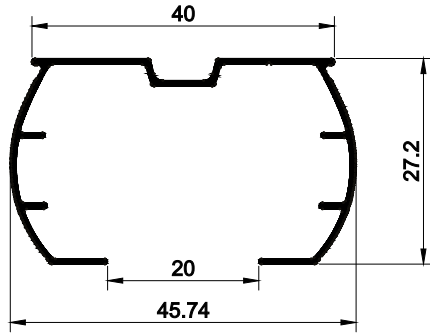

**EPS-1669**  
0,266 kg/m

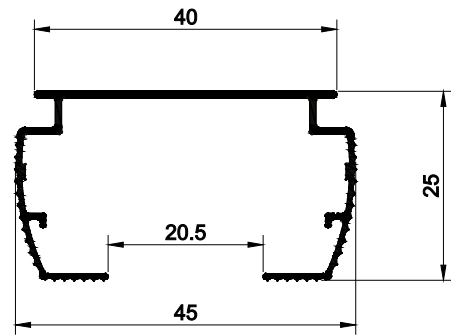

**EPS-1229**  
0,260 kg/m

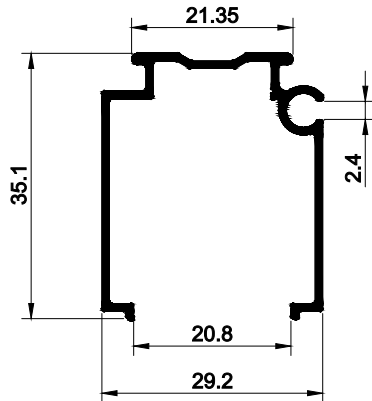

**EPS-3167**  
0,312 kg/m

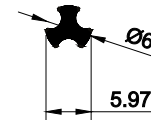

**EPS-0313**  
0,046 kg/m

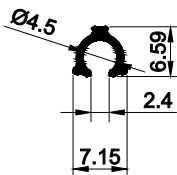

**EPS-1587**  
0,043 kg/m

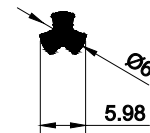

**EPS-0374**  
0,054 kg/m

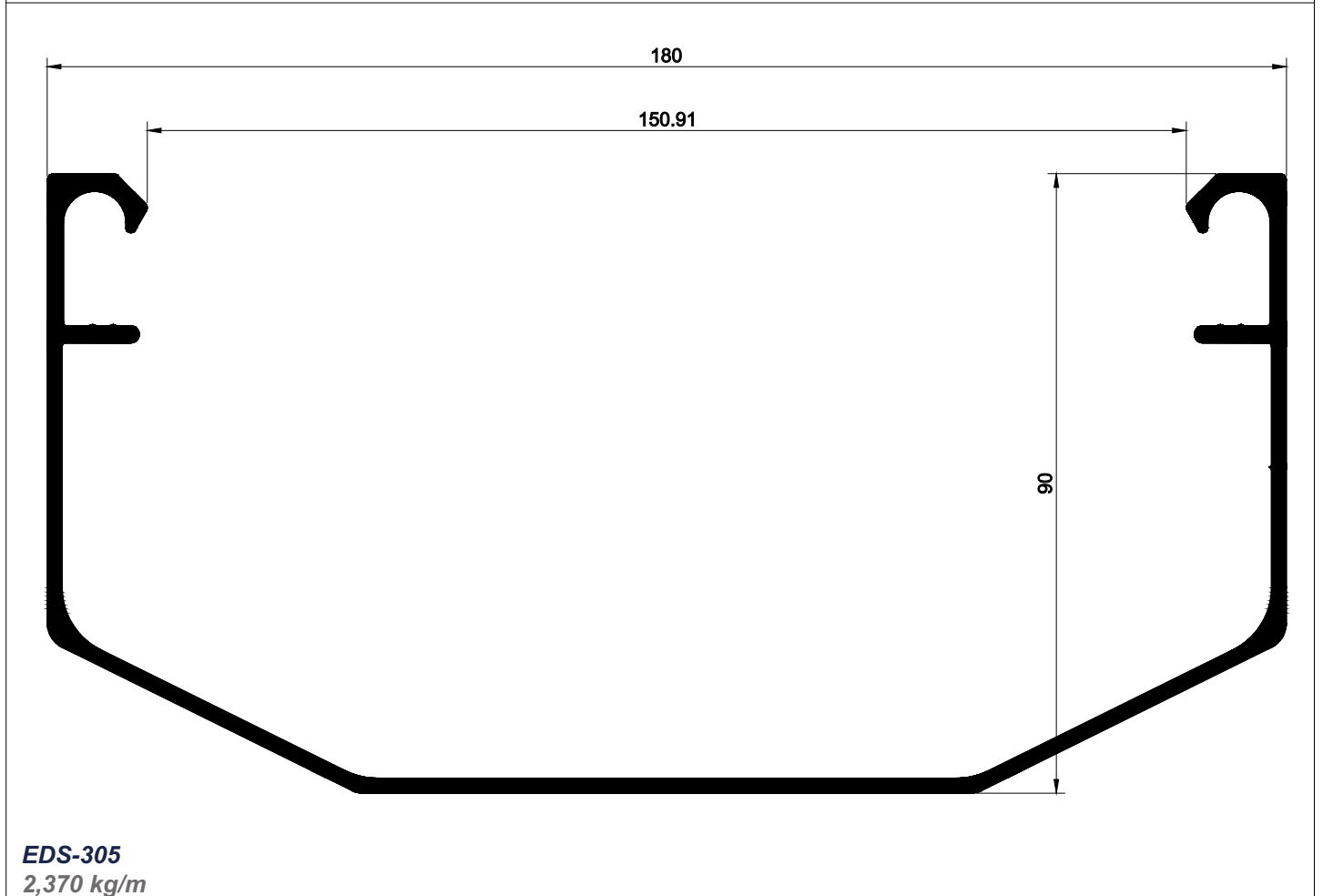
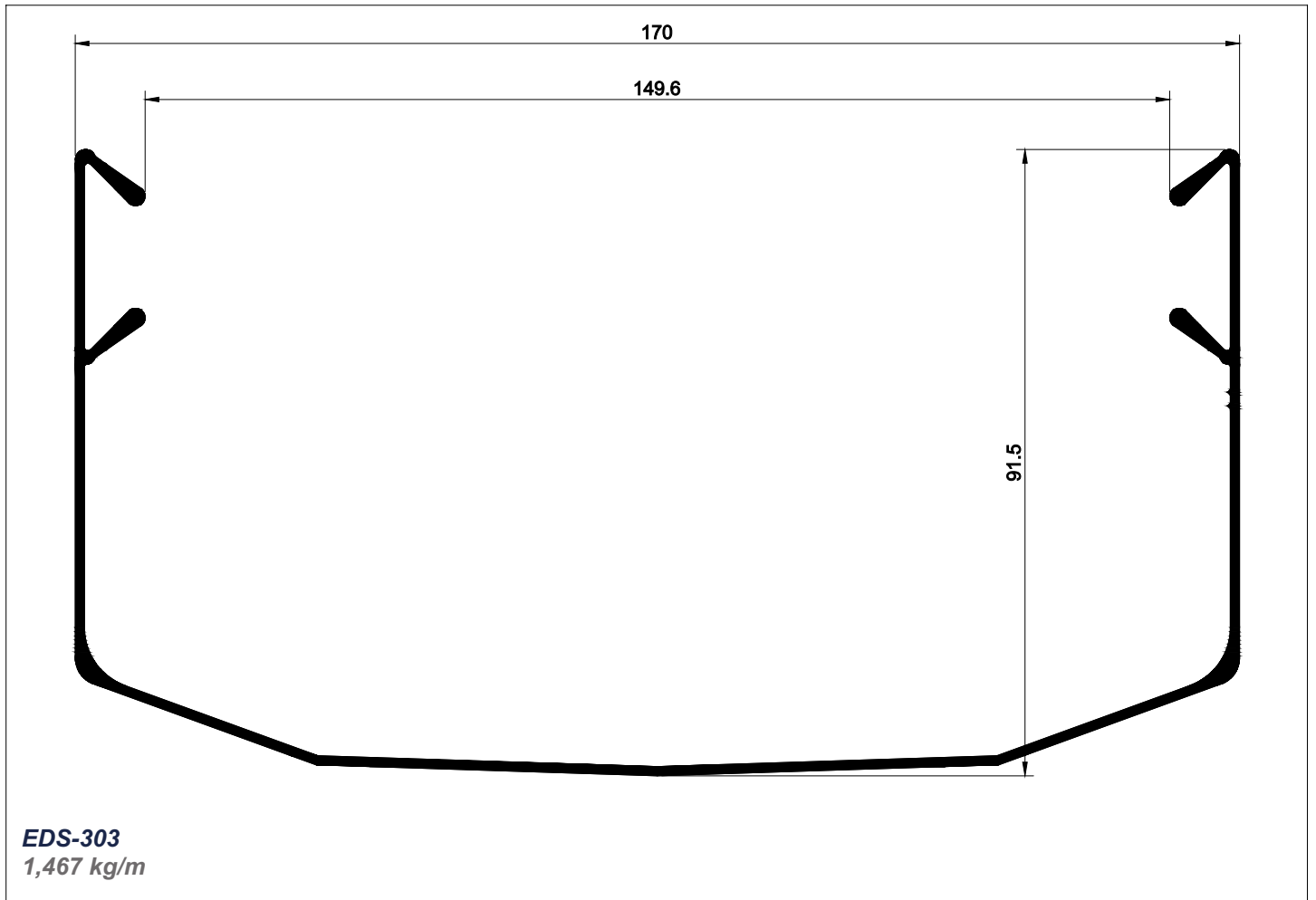

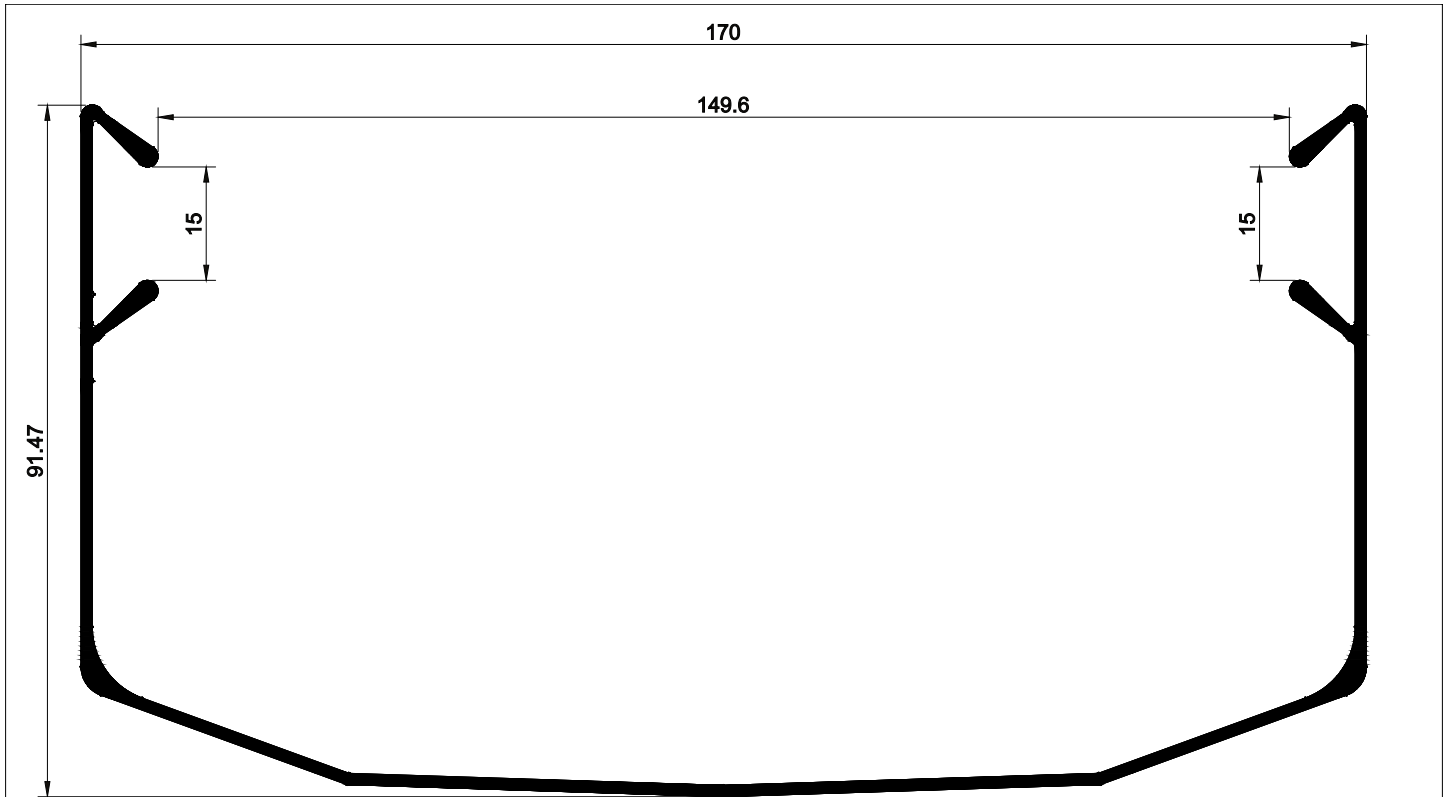

**EDS-301**  
1,604 kg/m

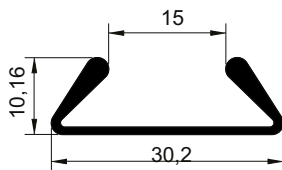

**ELN-018**  
0,200 kg/m

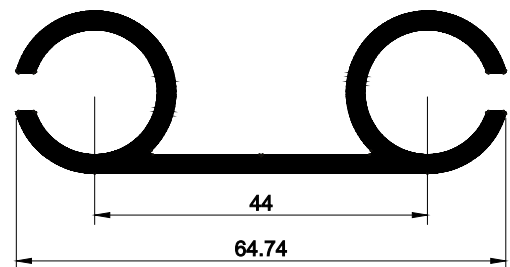

**ELN-142**  
0,976 kg/m

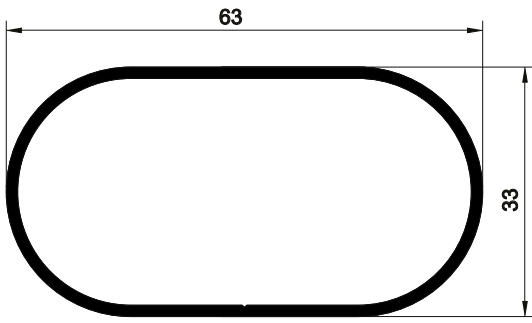

**EMV-010**  
0,646 kg/m

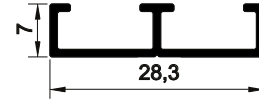

**ELN-216**  
0,144 kg/m

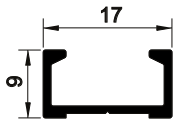

**ELN-161**  
0,111 kg/m

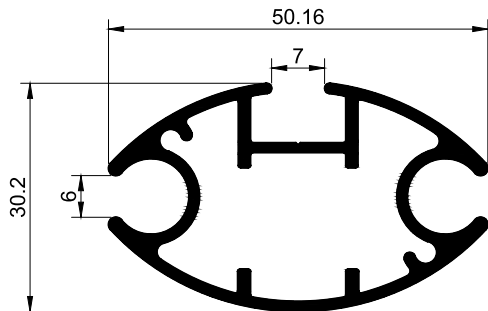

**EPS-3454**  
0,780 kg/m

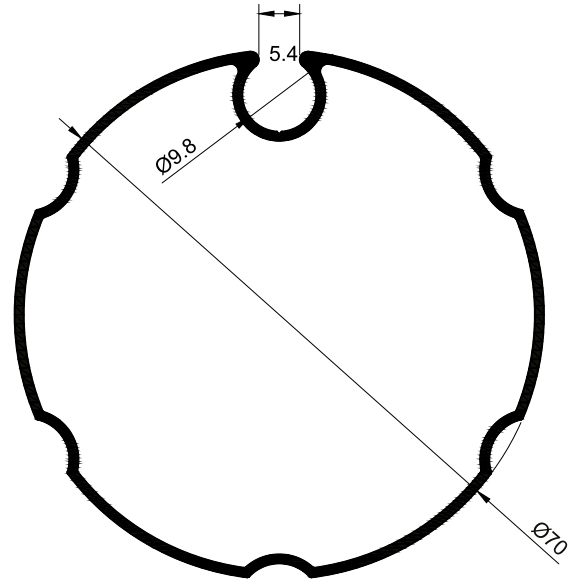

**EPS-3782**  
0,794 kg/m

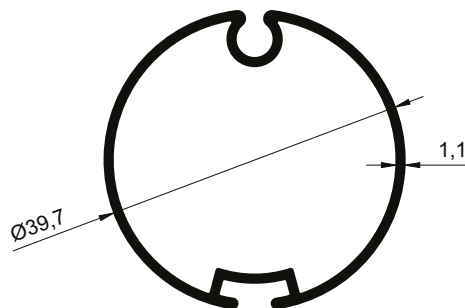

**EPS-816**  
0,434 kg/m

**COLUNA**

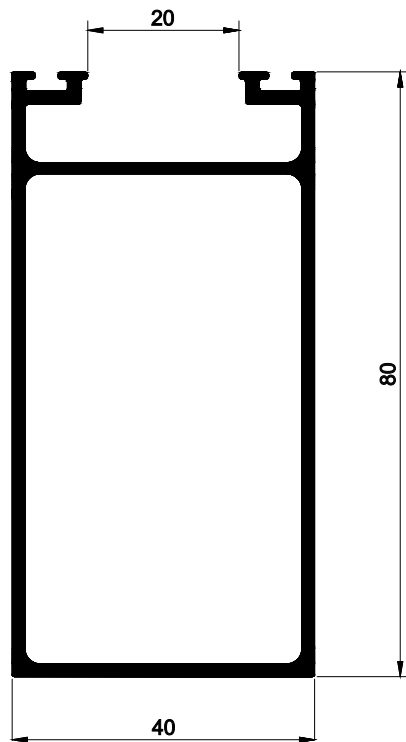

**EFC-012**  
1,184 kg/m

**COLUNA**

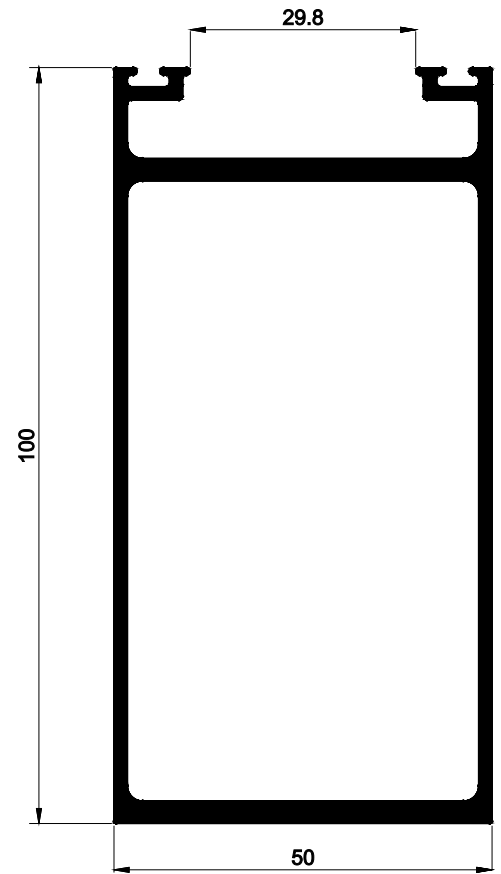

**EFC-112**  
1,857 kg/m

**ARREMATE 42mm**

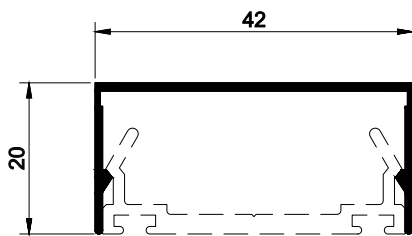

**EFC-013**  
0,236 kg/m

**TAMPA PARA ARREMATE 42mm**

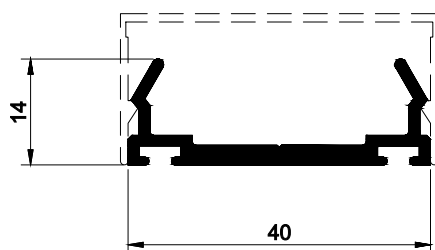

**EFC-014**  
0,369 kg/m

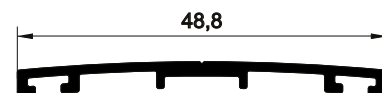

**EPE-005**  
0,233 kg/m

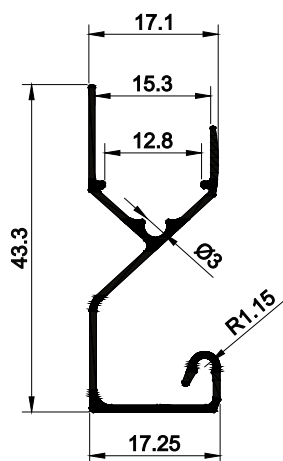

**EMV-026**

0,253 kg/m

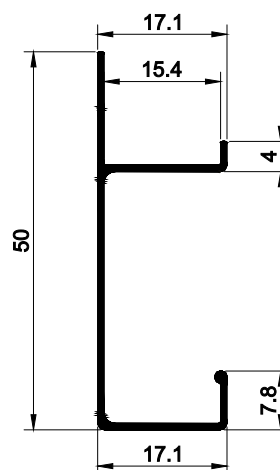

**EMV-101**

0,217 kg/m

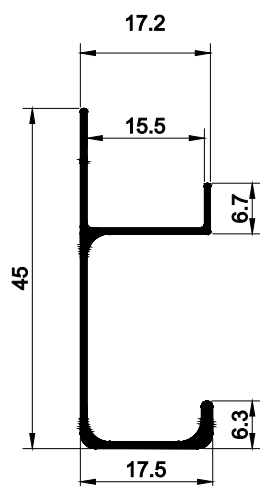

**EMV-070**

0,119 kg/m

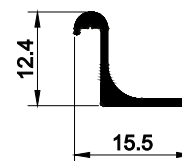

**EMV-100**

0,084 kg/m

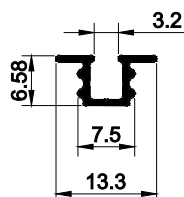

**EMV-005**

0,063 kg/m



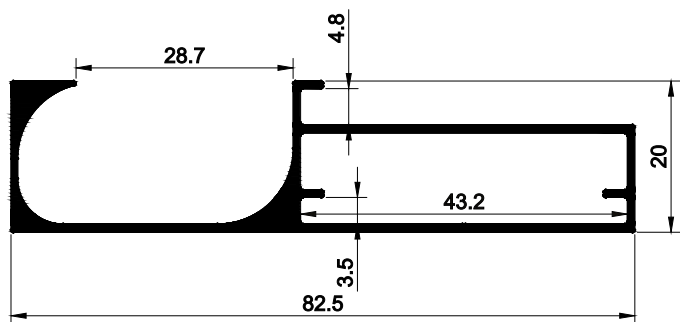

**EMV-048**  
0,675 kg/m

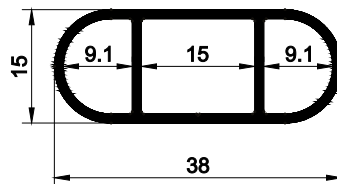

**EMV-013**  
0,371 kg/m

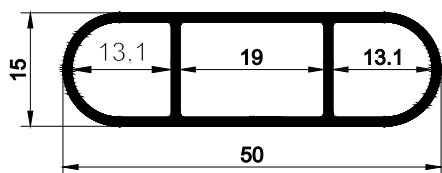

**EMV-162**  
0,450 kg/m

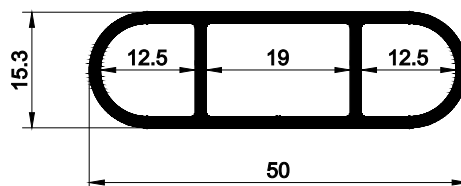

**EMV-061**  
0,558 kg/m

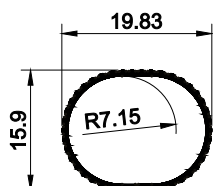

**EMV-072**  
0,103 kg/m

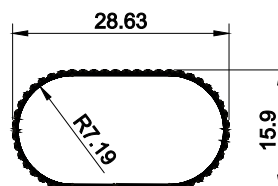

**EMV-071**  
0,119 kg/m

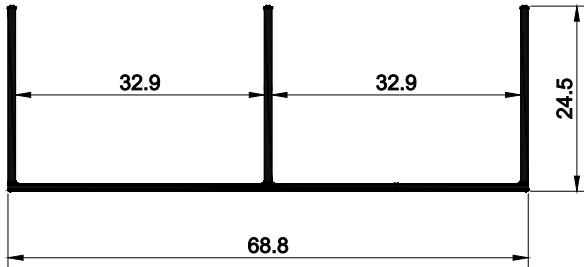

**EMV-001**  
0,376 kg/m

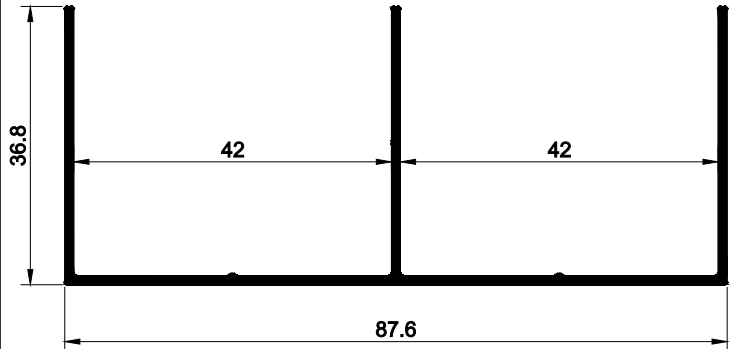

**EMV-042**  
0,282 kg/m

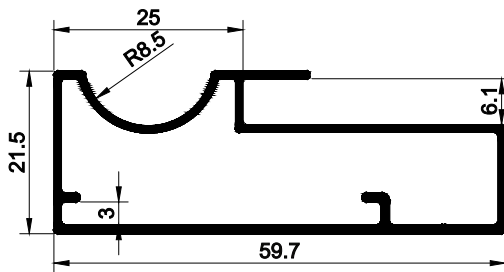

**EMV-003**  
0,531 kg/m

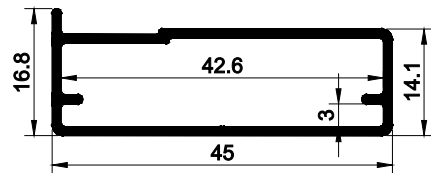

**EMV-049**  
0,393 kg/m

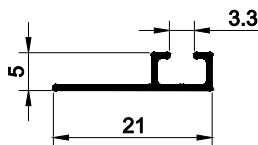

**EMV-006**  
0,065 kg/m

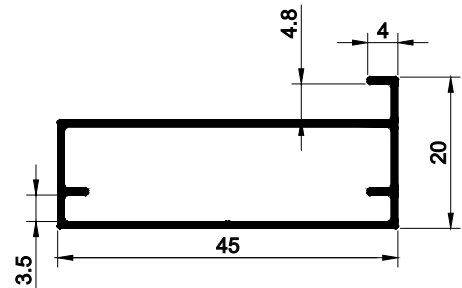

**EMV-047**  
0,317 kg/m

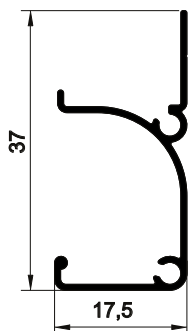

**EMV-007**  
0,183 kg/m

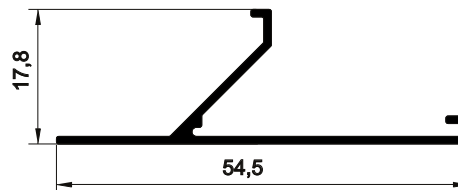

**EMV-030**  
0,230 kg/m

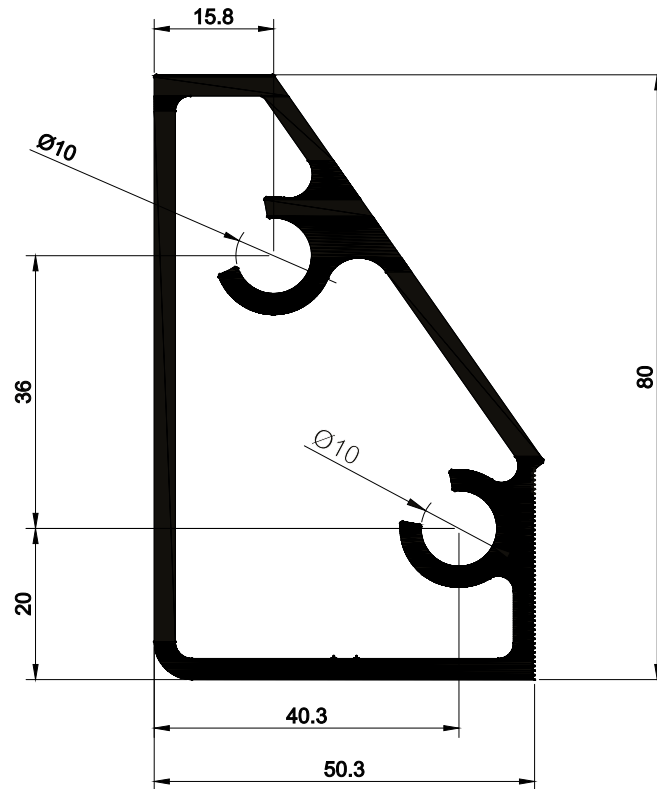

**ESC-005**  
2,305 kg/m

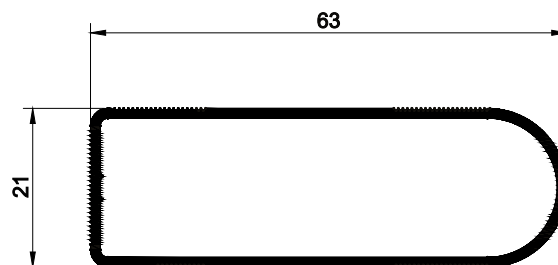

**ESC-024**  
0,512 kg/m

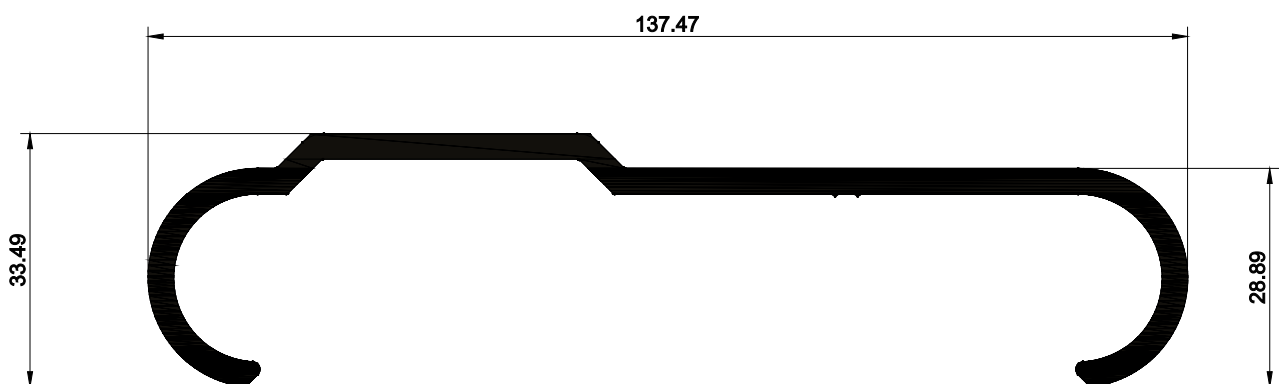

**ESC-006**  
1,768 kg/m

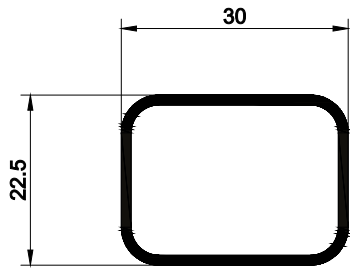

**ESC-003**  
0,328 kg/m

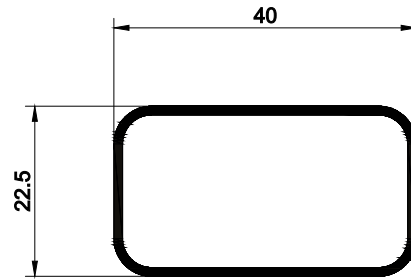

**ESC-002**  
0,349 kg/m

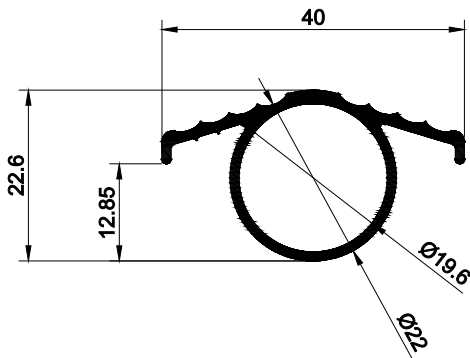

**ESC-050**  
0,350 kg/m

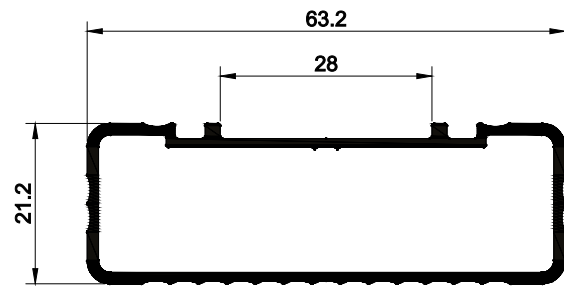

**ESC-036**  
0,589 kg/m

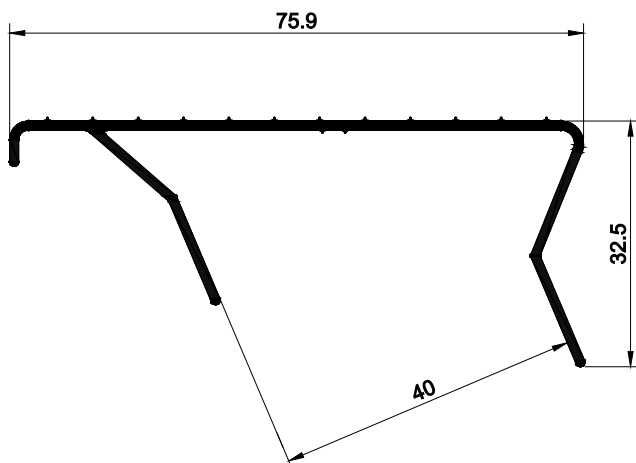

**ESC-020**  
0,465 kg/m

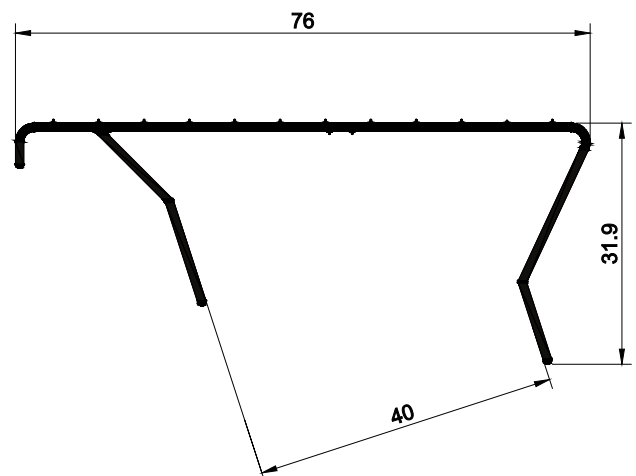

**ESC-021**  
0,417 kg/m

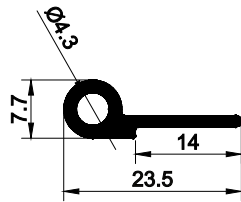

**EAC-006**  
0,165 kg/m

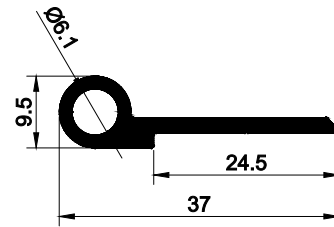

**EAC-007**  
0,287 kg/m

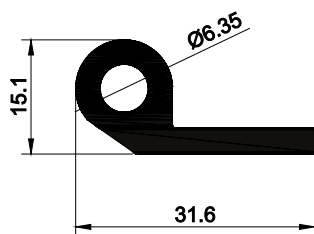

**EAC-009**  
0,505 kg/m

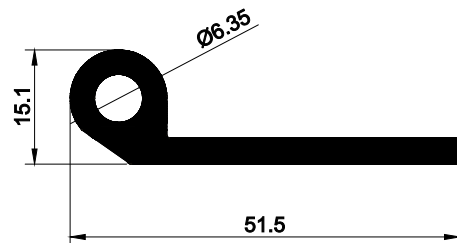

**EAC-008**  
0,694 kg/m

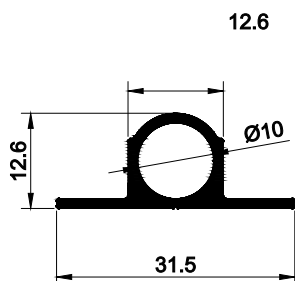

**EAC-013**  
0,452 kg/m

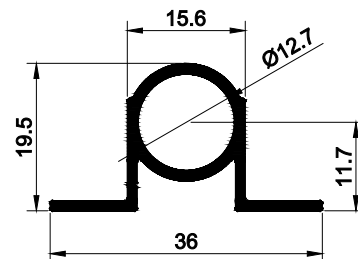

**EAC-160**  
0,312 kg/m



**EAC-2029**  
0,317 kg/m

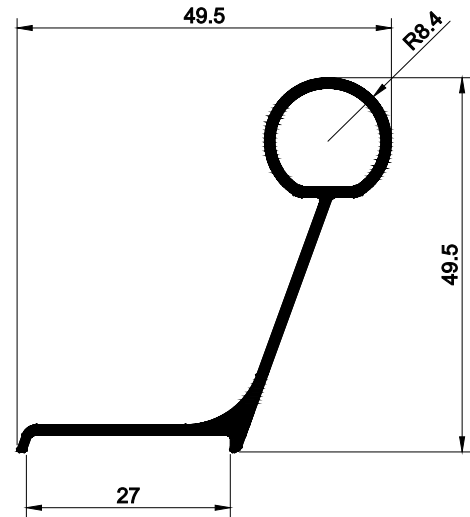

**EAC-1468**  
0,458 kg/m

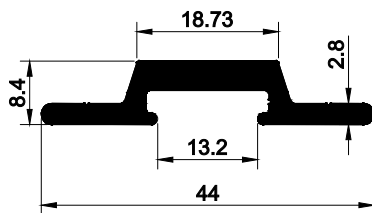

**EAC-012**  
0,452 kg/m

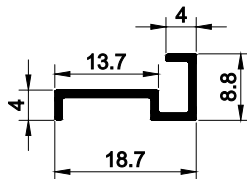

**EAC-2027**  
0,458 kg/m

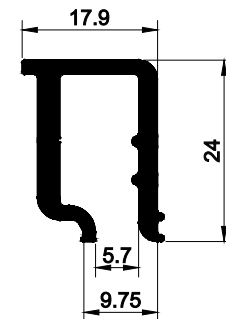

**EAC-130**  
0,425 kg/m

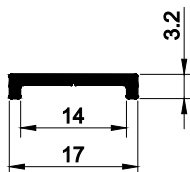

**EAC-2030**  
0,078 kg/m

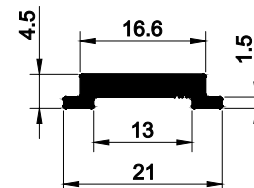

**EAC-2028**  
0,166 kg/m

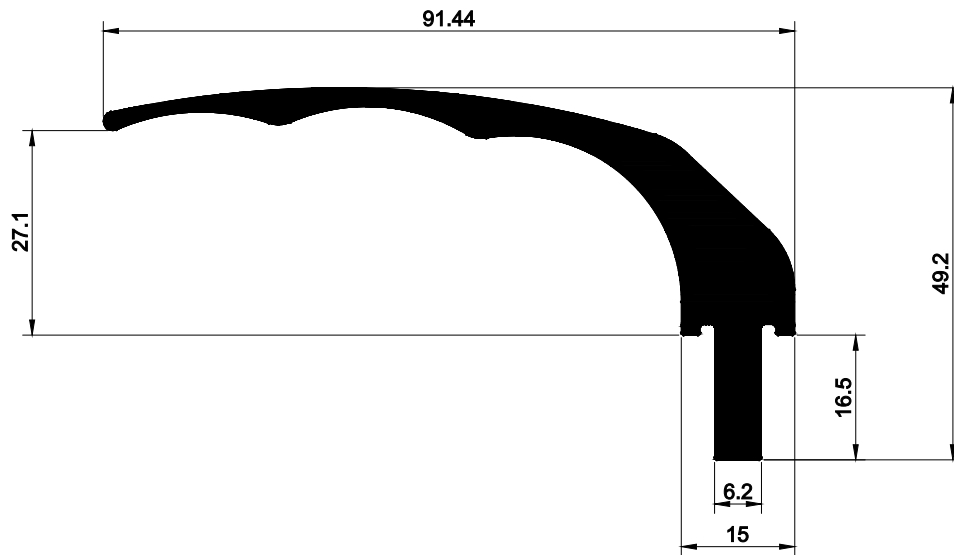

**EAC-001**  
1,848 kg/m

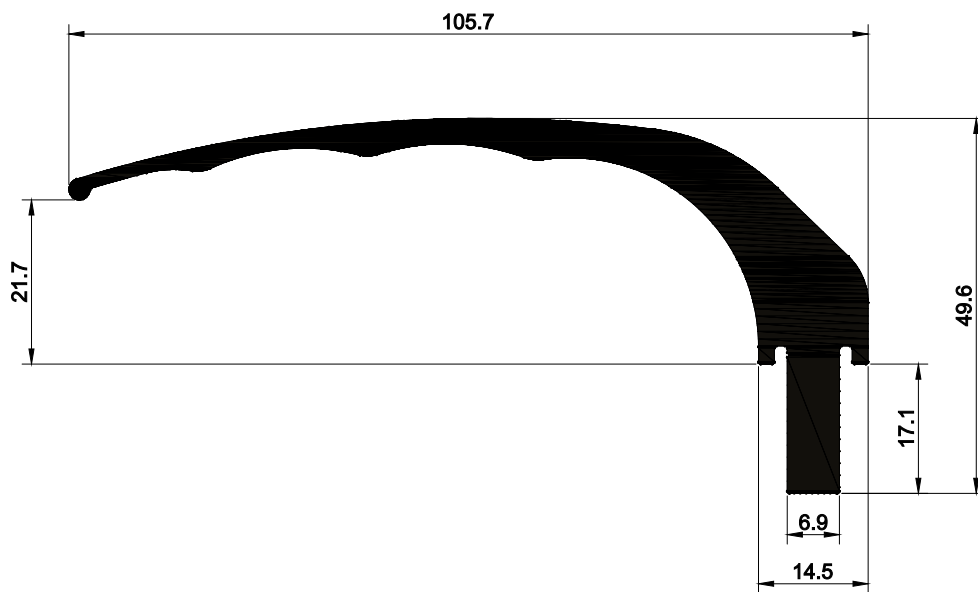

**EAC-011**  
2,147 kg/m

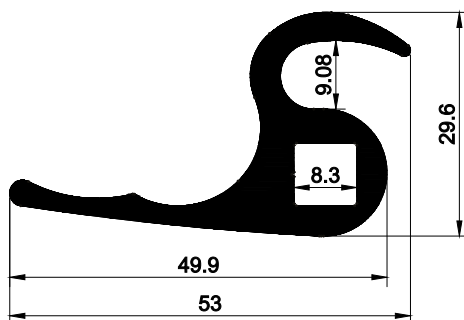

**EAC-2057**  
1,067 kg/m

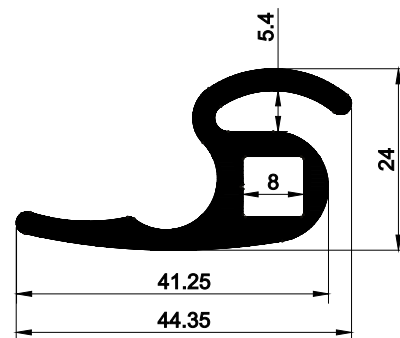

**EAC-2056**  
0,807 kg/m



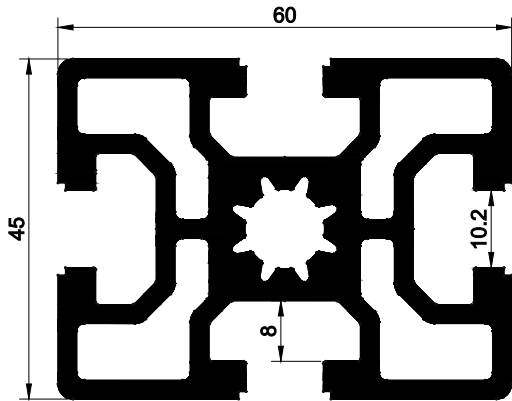

**EDS-466**  
2,981 kg/m

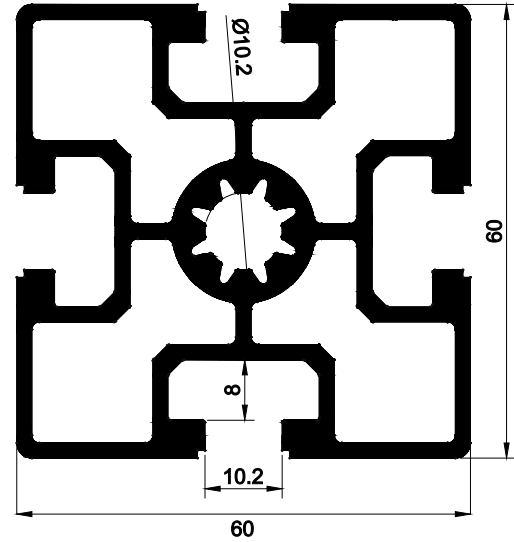

**EDS-207**  
2,921 kg/m

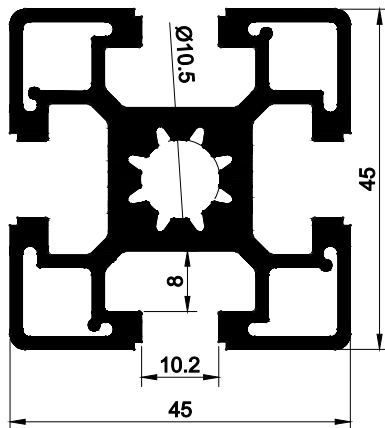

**EDS-206**  
1,902 kg/m

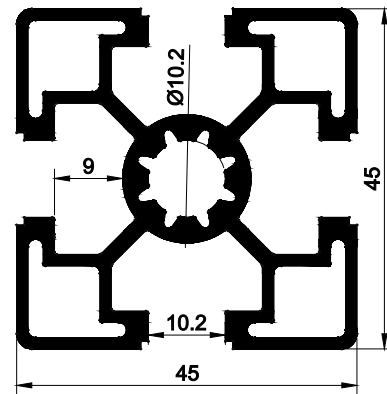

**EDS-453**  
1,545 kg/m

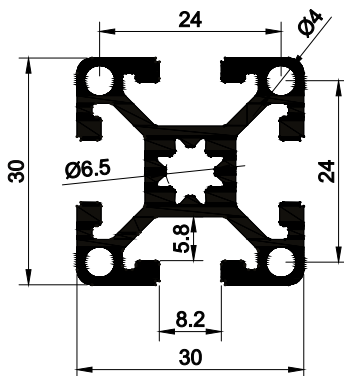

**EDS-205**  
0,908 kg/m

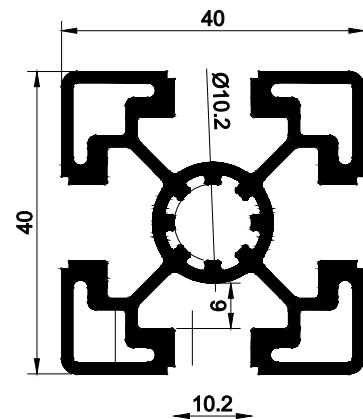

**EDS-365**  
1,349 kg/m

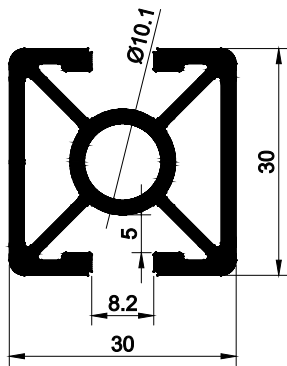

**EDS-726**  
0,935 kg/m

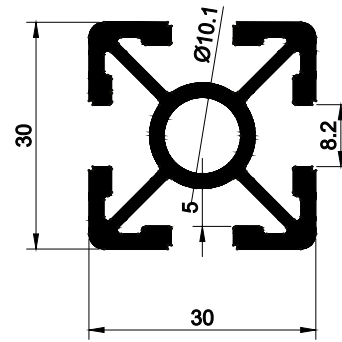

**EDS-727**  
0,886 kg/m

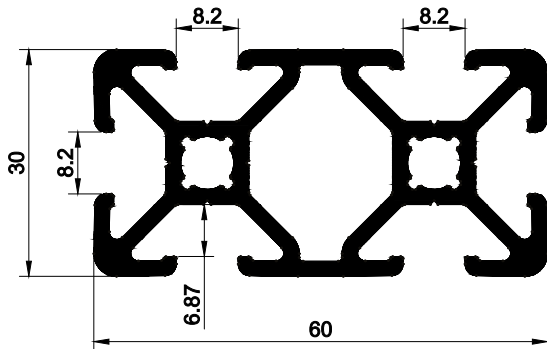

**EDS-828**  
1,550 kg/m

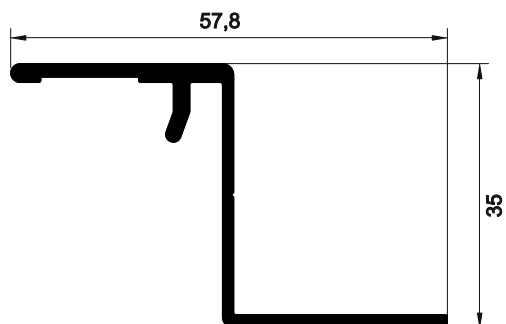

**EIR-007**  
0,486 kg/m

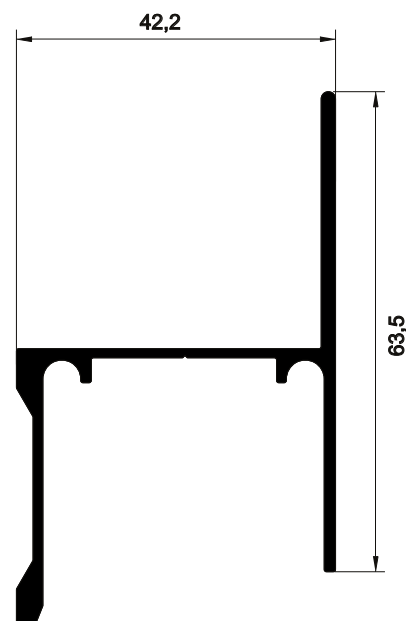

**EIR-008**  
0,668 kg/m

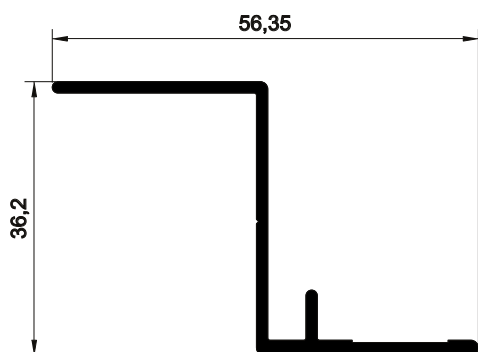

**EIR-009**  
0,421 kg/m

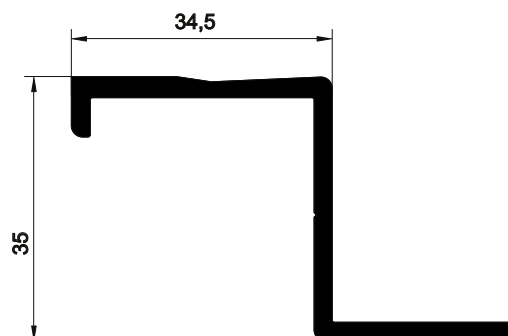

**EIR-010**  
0,646 kg/m



**EIR-011**  
0,229 kg/m

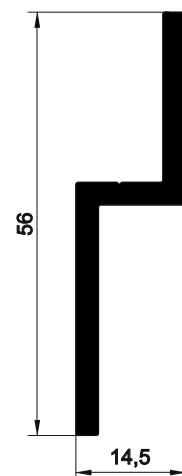

**EIR-012**  
0,548 kg/m

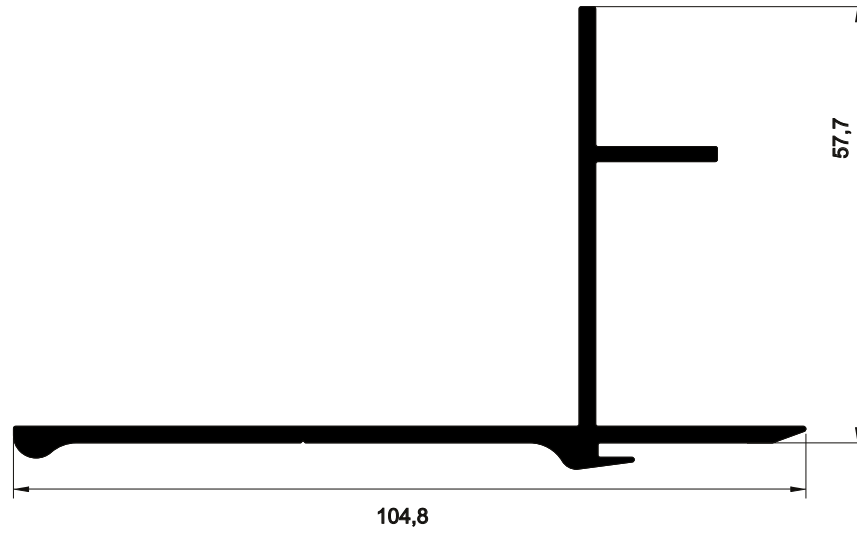

**EIR-004**  
1,119 kg/m

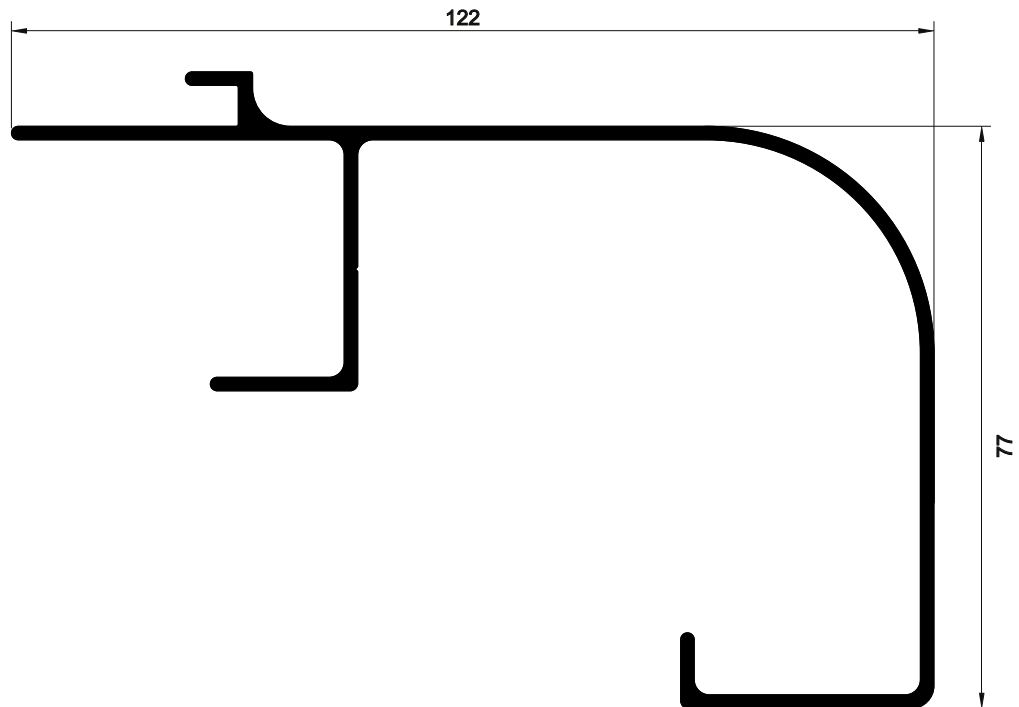

**EIR-005**  
1,431 kg/m

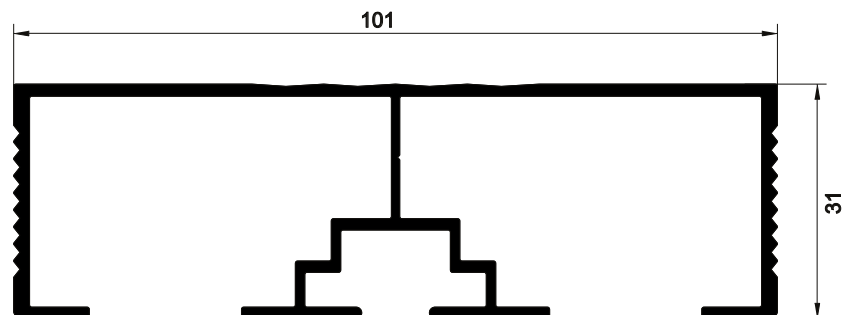

**EIR-006**  
1,130 kg/m

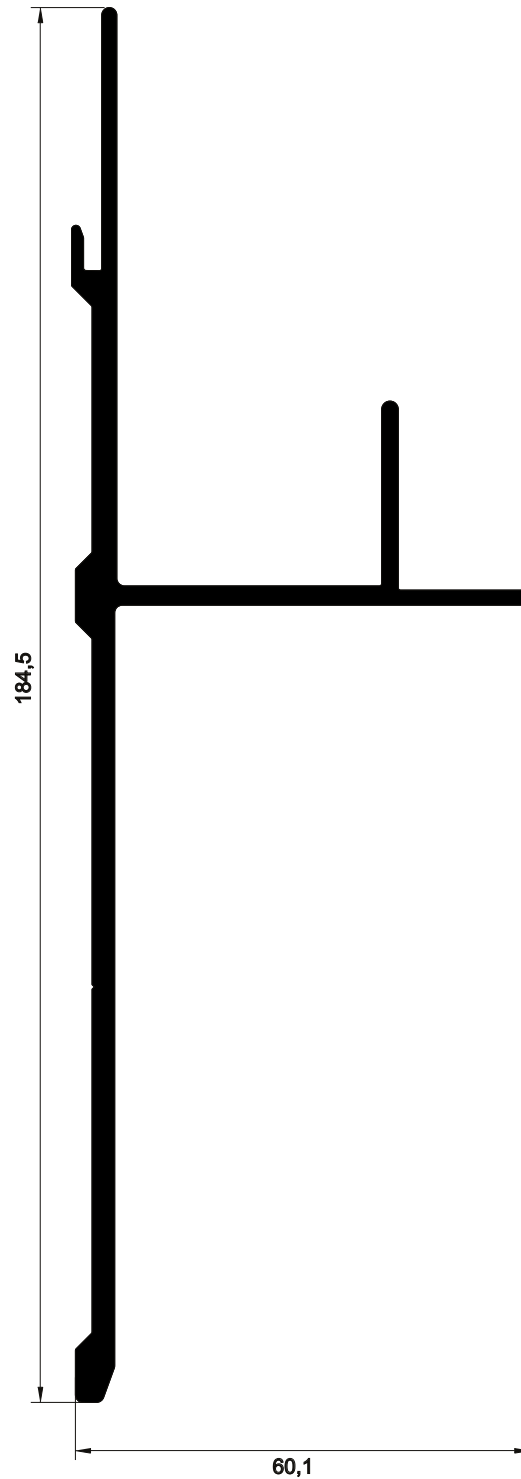

**EIR-015**  
2,075 kg/m

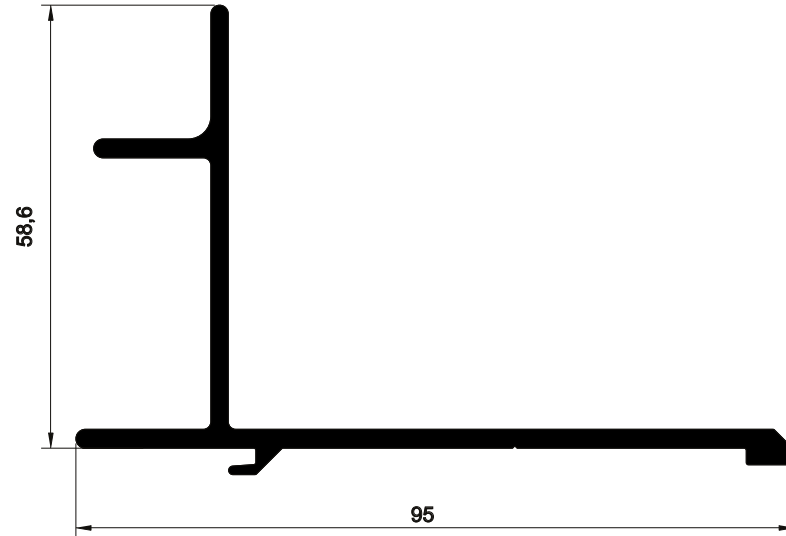

**EIR-001**  
1,156 kg/m

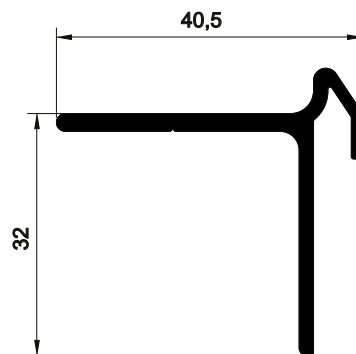

**EIR-002**  
0,454 kg/m

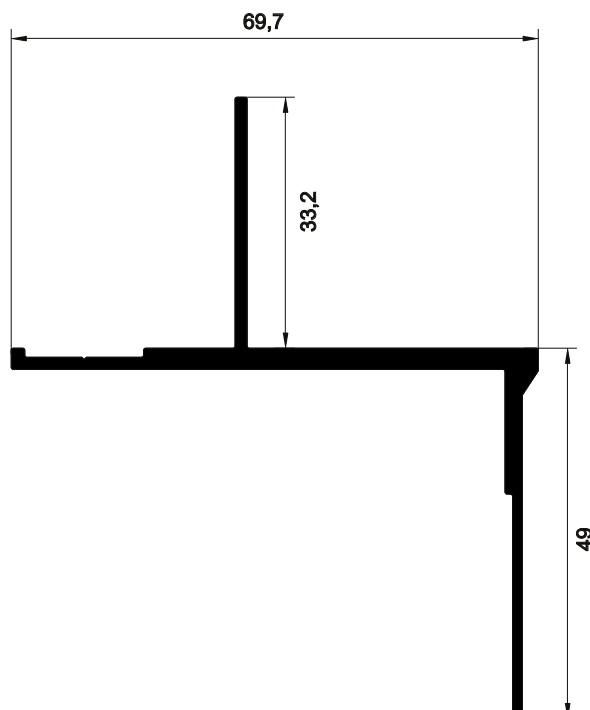

**EIR-003**  
0,839 kg/m

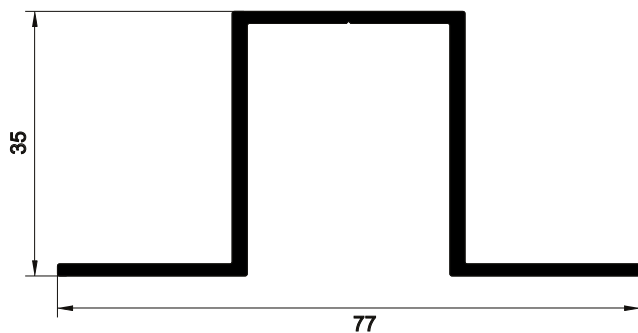

**EIR-013**  
0,695 kg/m

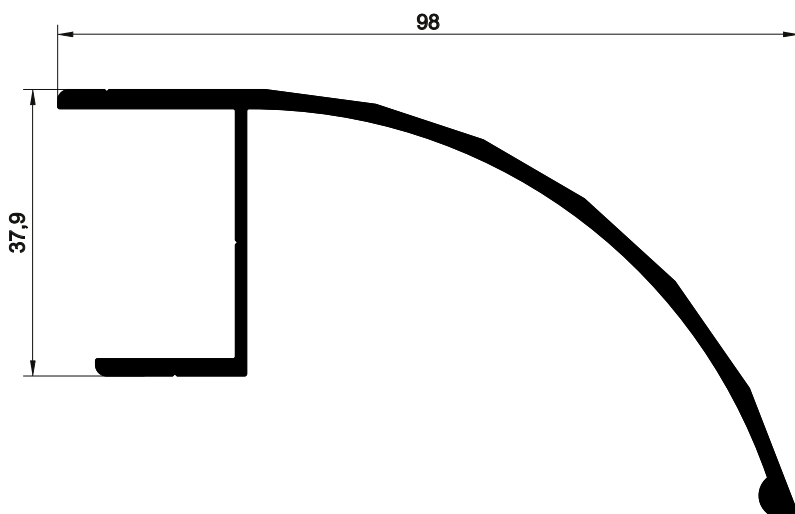

**EIR-014**  
1,044 kg/m

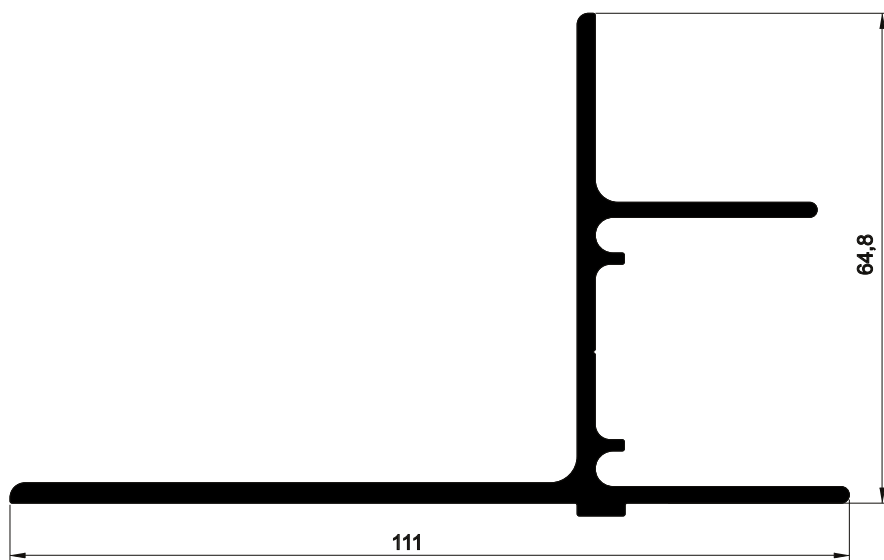

**EIR-016**  
0,668 kg/m

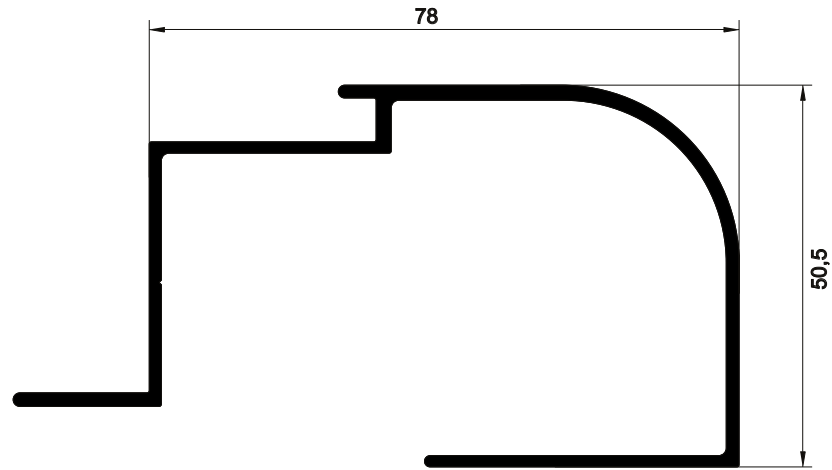

**EIR-022**  
1,008 kg/m

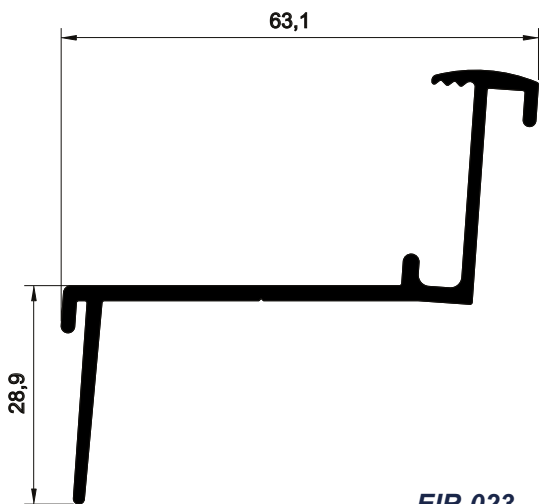

**EIR-023**  
0,667 kg/m

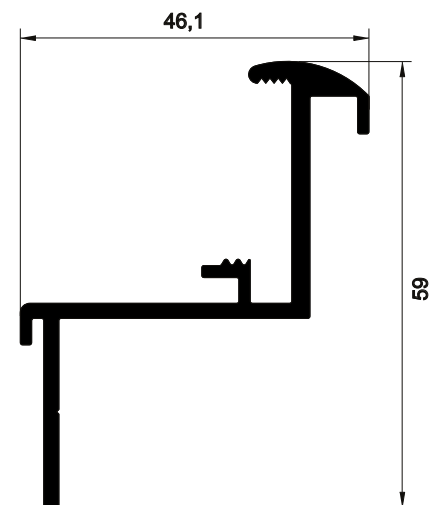

**EIR-024**  
0,722 kg/m

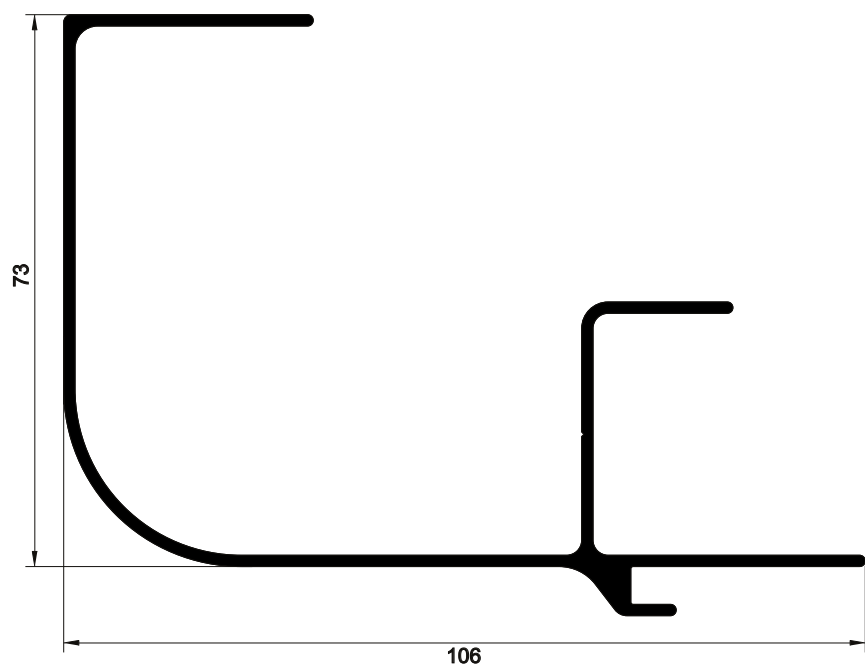

**EIR-025**  
1,121 kg/m



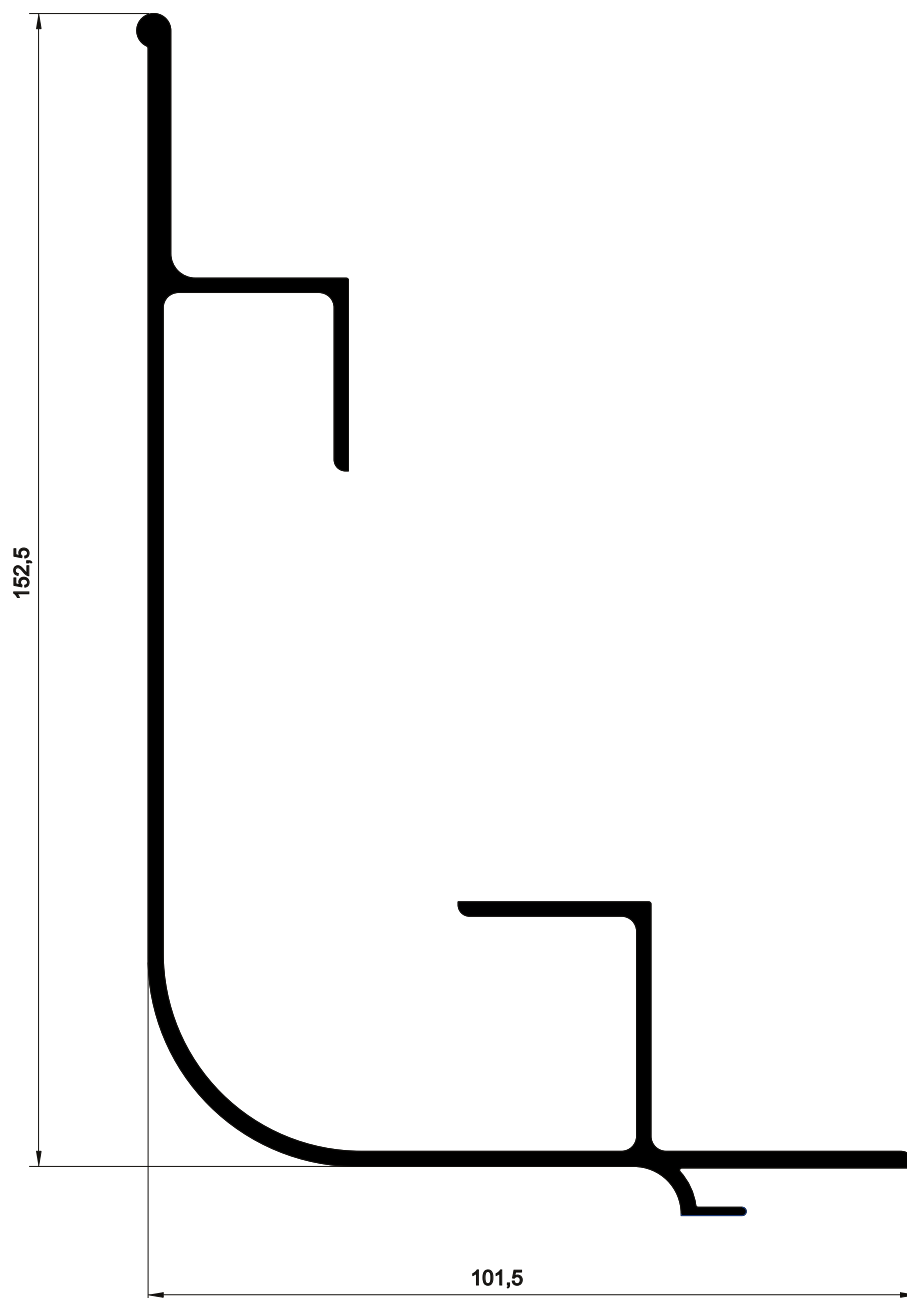

**EIR-020**  
2,058 kg/m

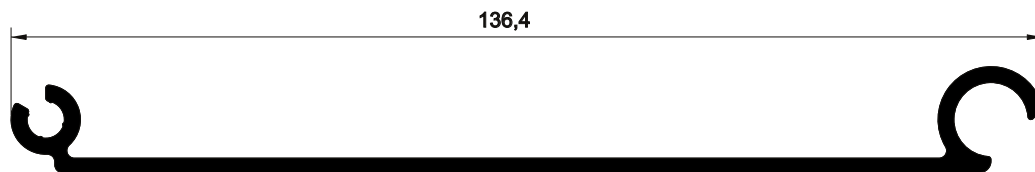

**EIR-029**  
0,889 kg/m

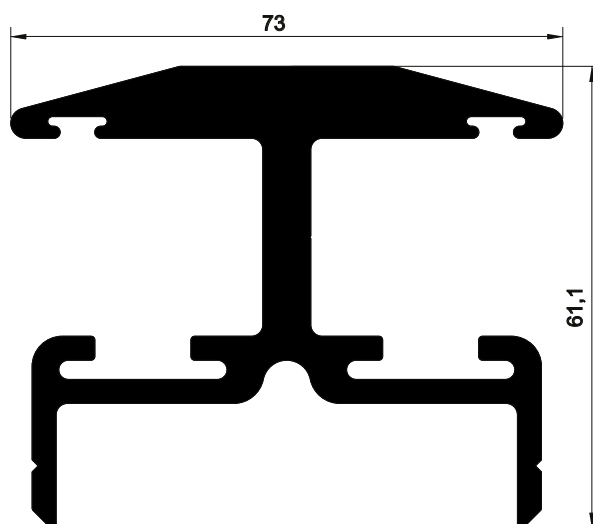

**EIR-030**  
3,124 kg/m

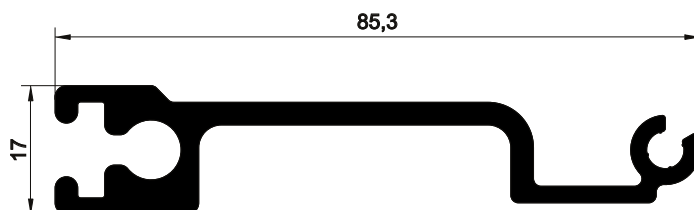

**EIR-031**  
1,137 kg/m

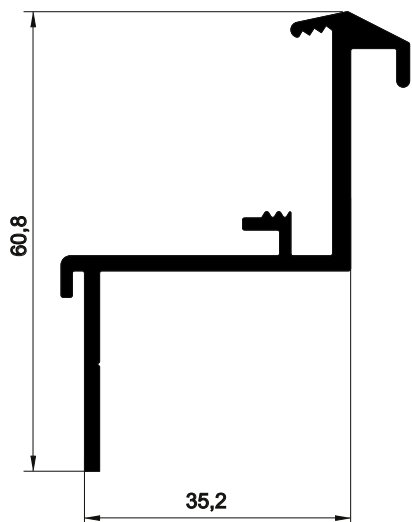

**EIR-026**  
0,724 kg/m

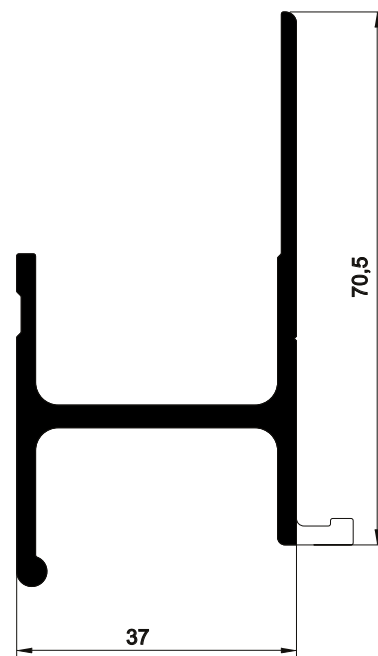

**EIR-028**  
1,071 kg/m

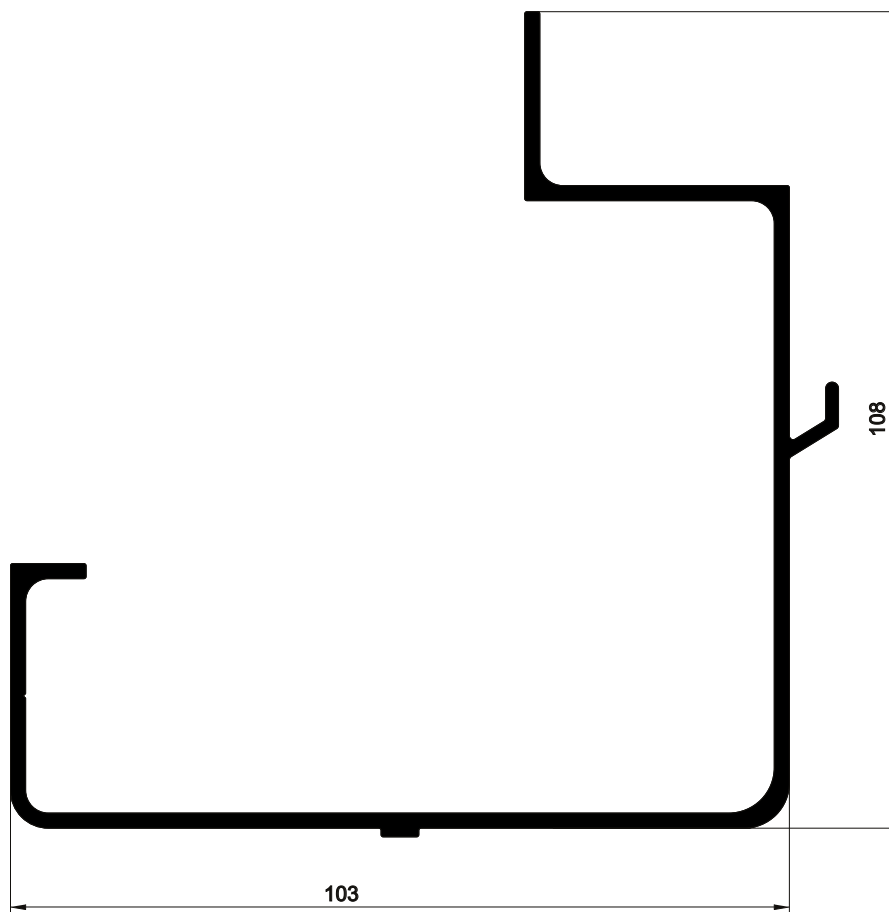

**EIR-027**  
1,611 kg/m

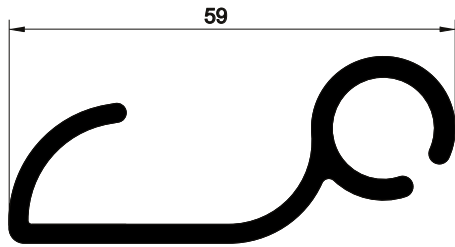

**EIR-039**  
0,808 kg/m

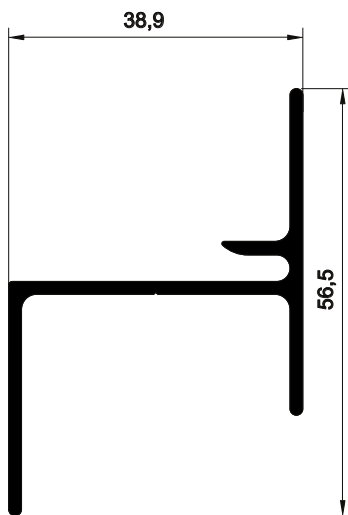

**EIR-041**  
0,552 kg/m

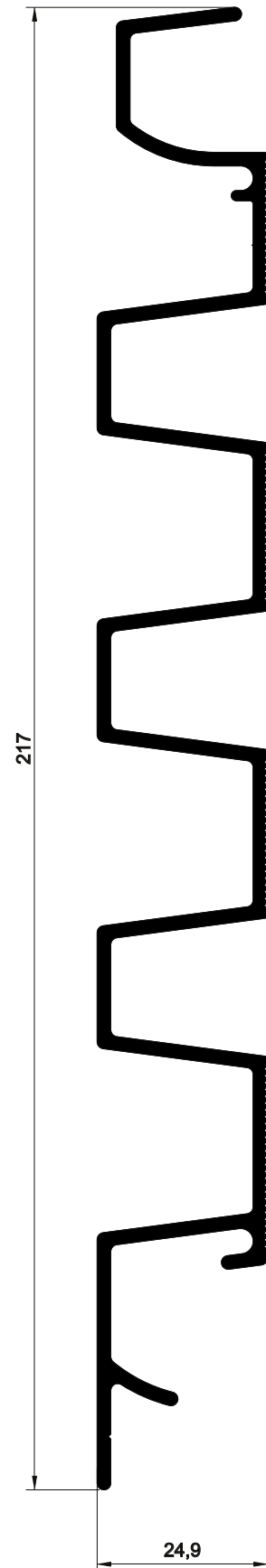

**EIR-040**  
2,202 kg/m

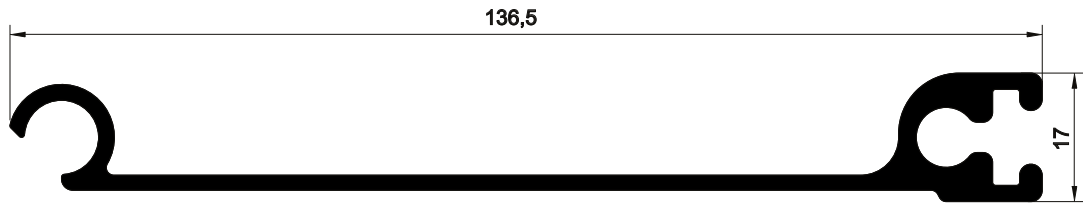

**EIR-032**  
1,221 kg/m

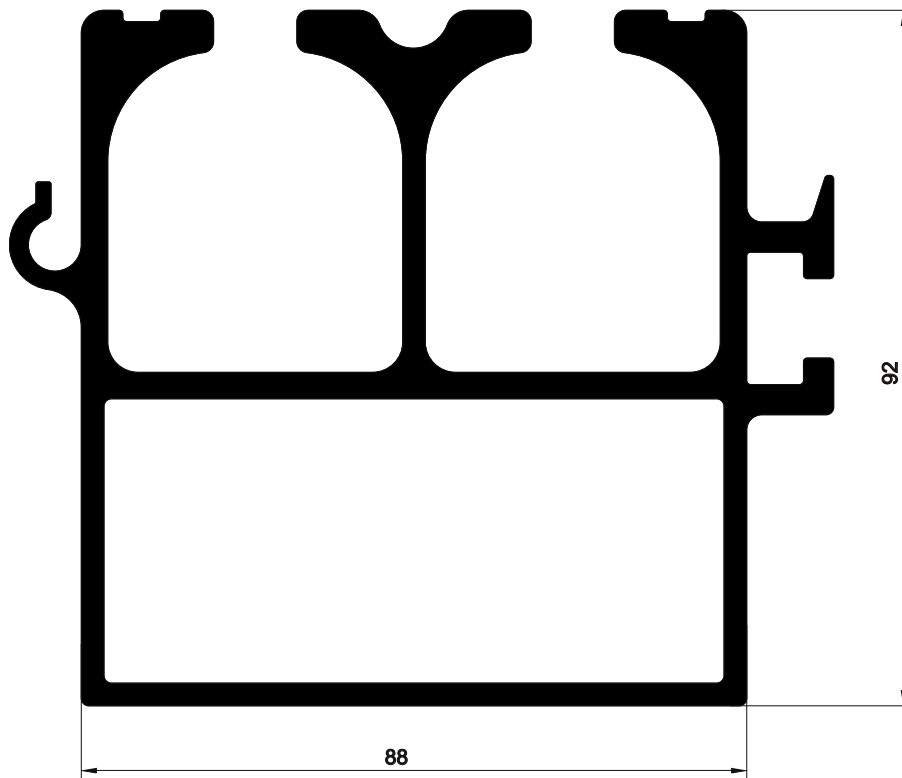

**EIR-033**  
5,166 kg/m

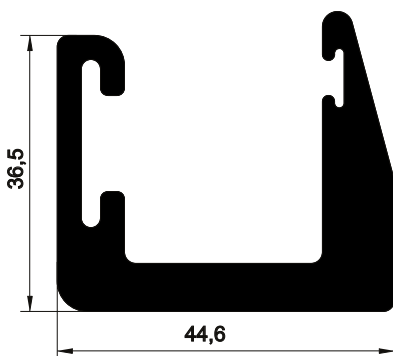

**EIR-034**  
1,841 kg/m

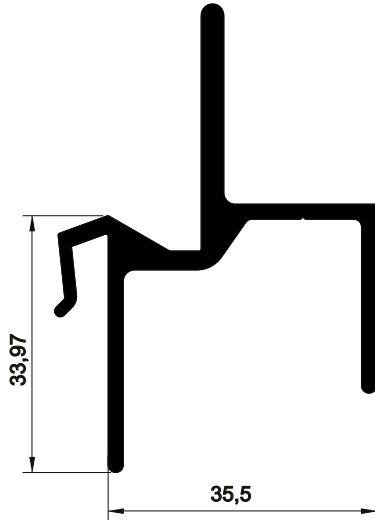

**EIR-017**  
0,894 kg/m

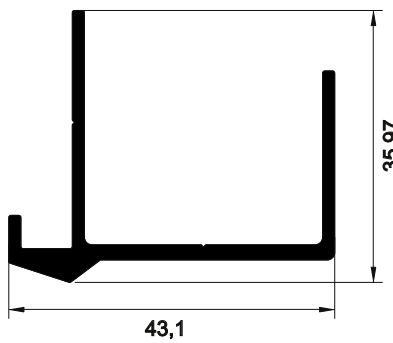

**EIR-018**  
0,528 kg/m

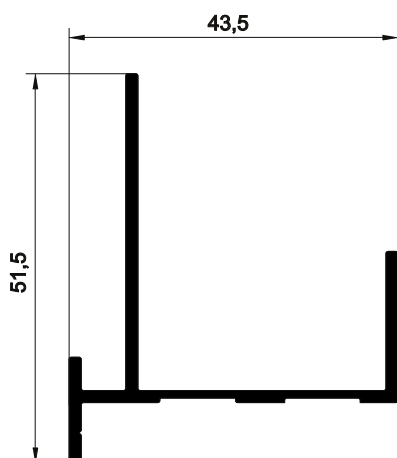

**EIR-019**  
0,528 kg/m

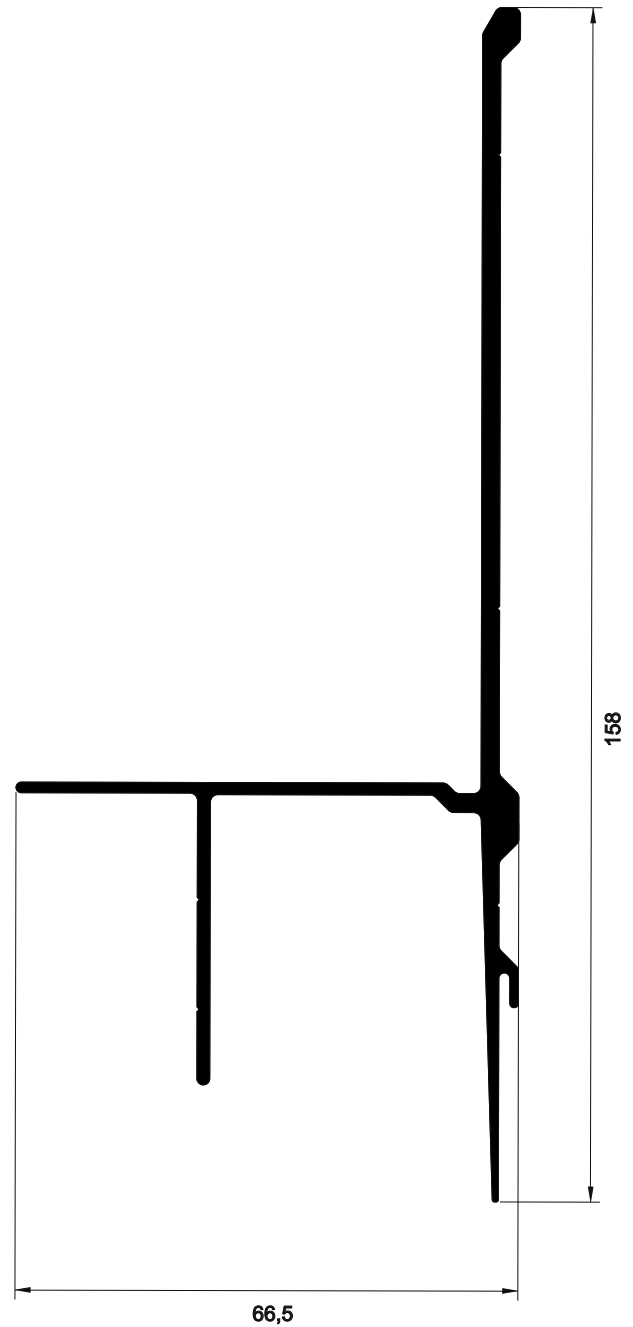

**EIR-021**  
1,484 kg/m

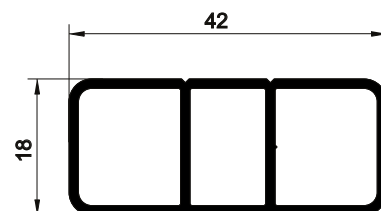
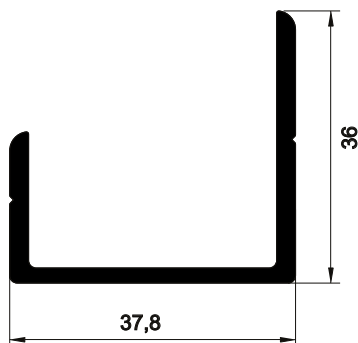
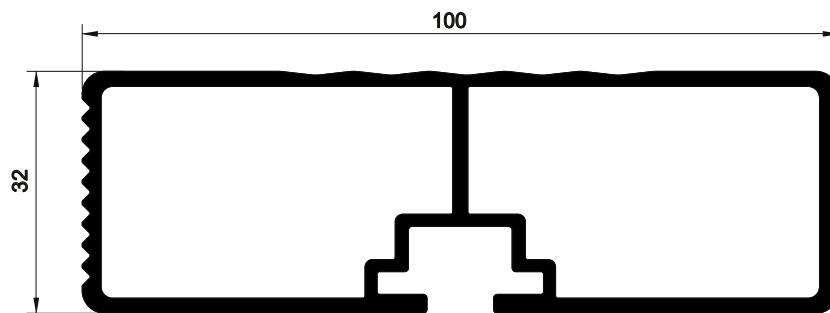
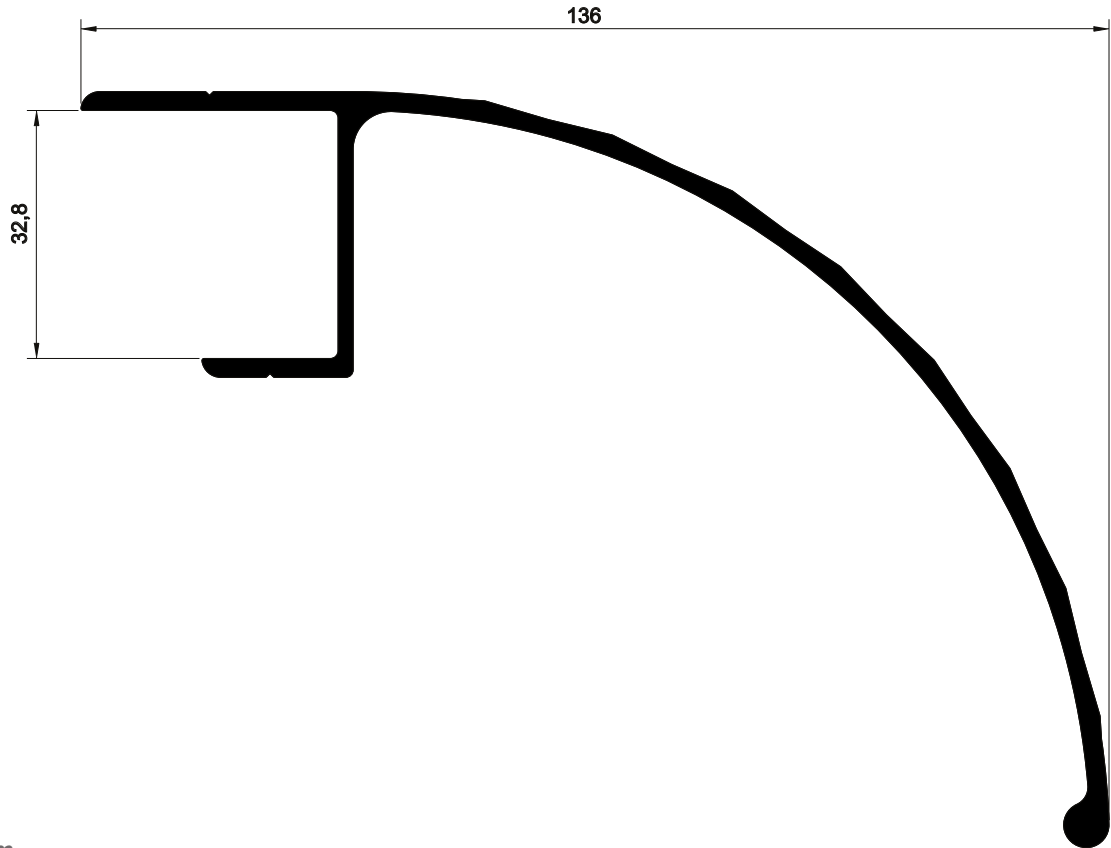

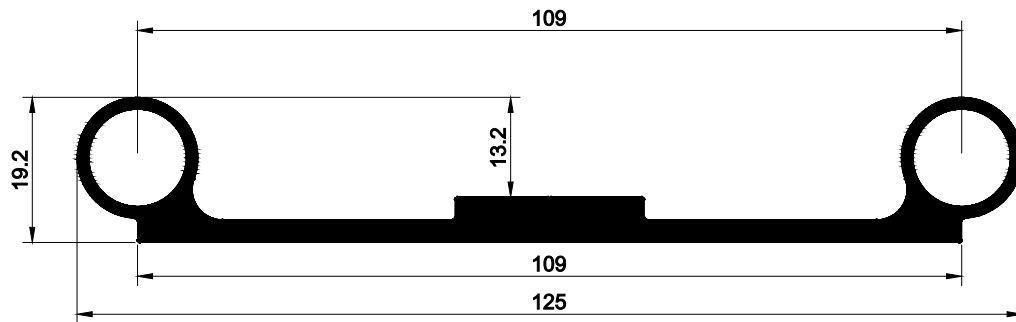

**EDS-011**  
1,555 kg/m

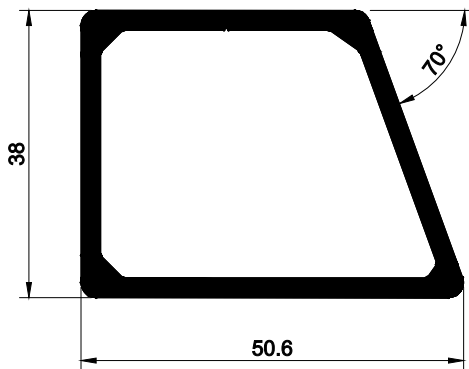

**EDS-1378**  
1,135 kg/m

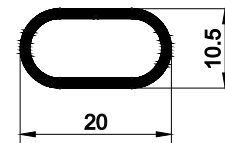

**EDS-221**  
0,168 kg/m

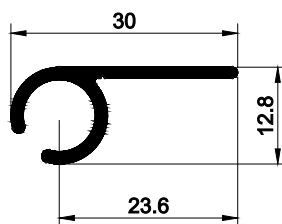

**EDS-590**  
0,217 kg/m



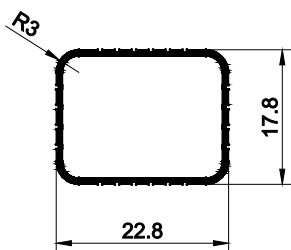

**EFL-001**  
0,160 kg/m

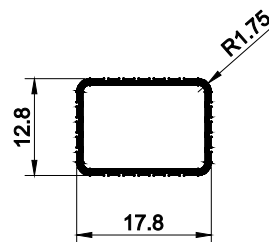

**EFL-002**  
0,119 kg/m

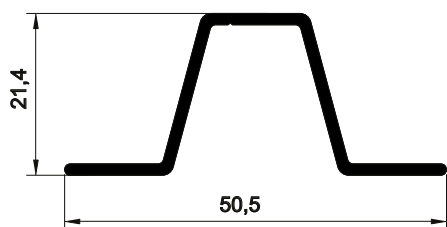

**EDS-781**  
0,325 kg/m

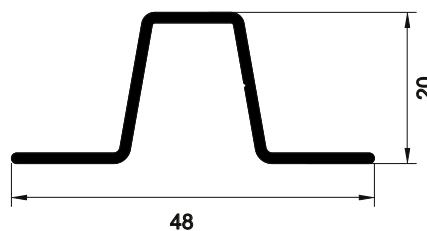

**EDS-766**  
0,431 kg/m

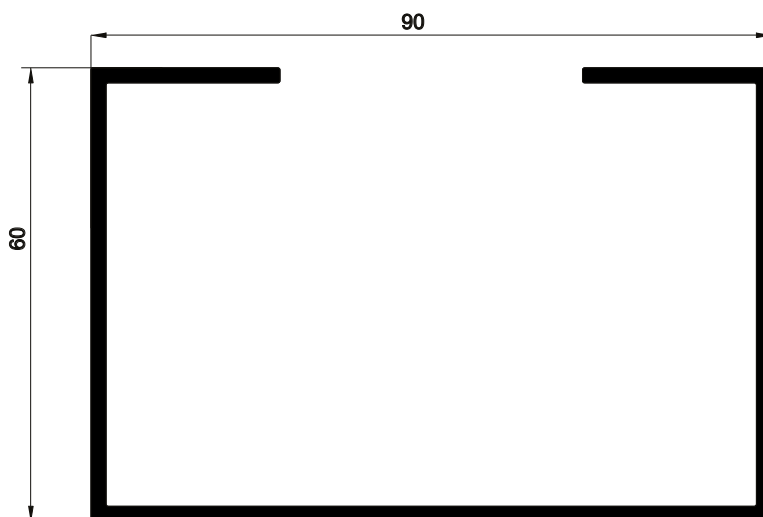

**ELN-284**  
1,365 kg/m

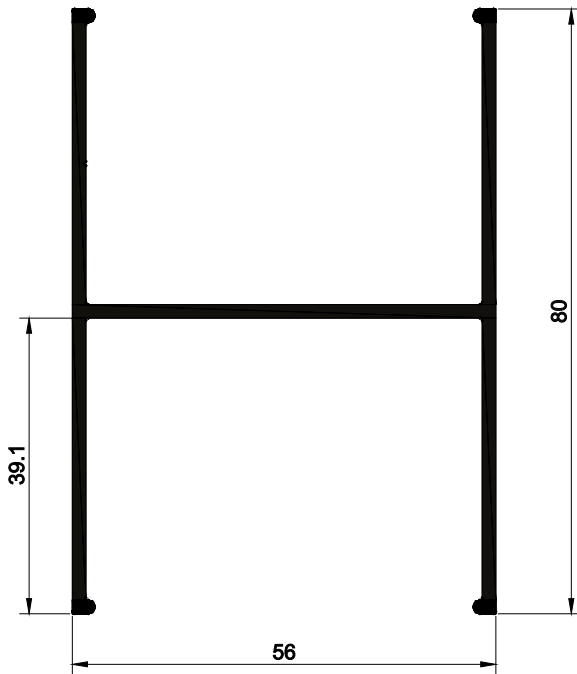

**EDS-477**  
1,057 kg/m

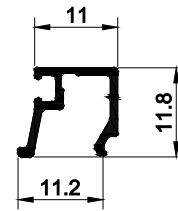

**EBG-001**  
0,103 kg/m

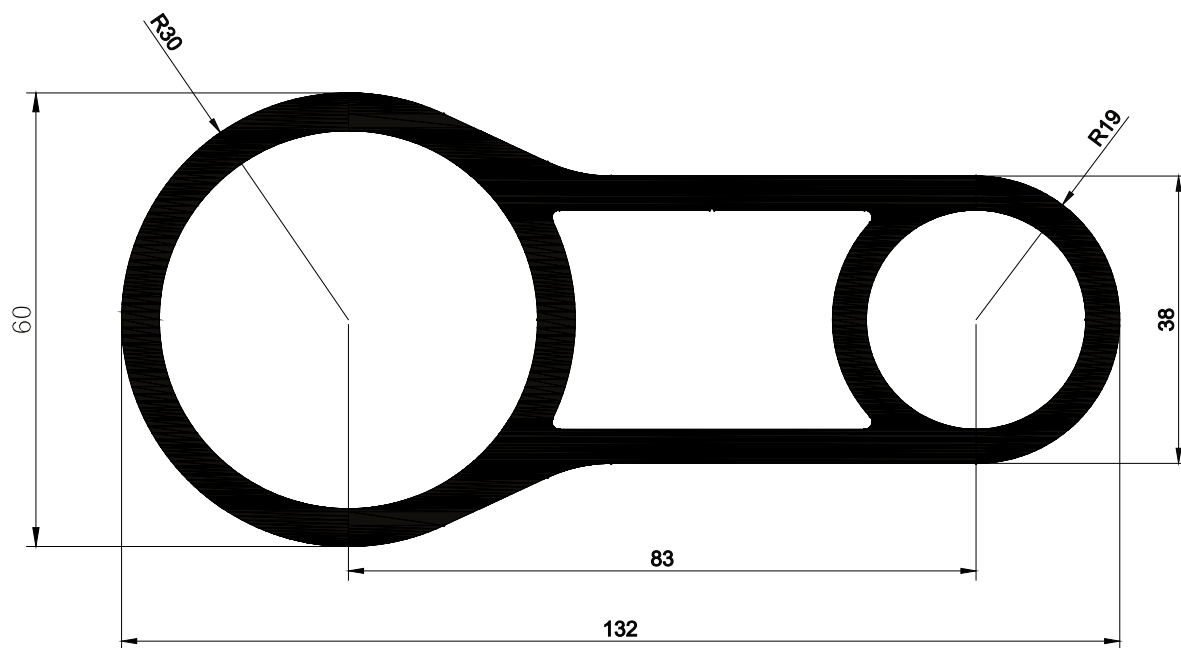

**EDS-994**  
4,987 kg/m

# SOLUÇÕES

Soluções de grande complexidade, extrema precisão e tolerâncias dimensionais. Para obter resultados positivos é fundamental possuir como base para o desenvolvimento das atividades um local apropriado que atenda a todas as necessidades tanto dos profissionais como dos produtos a serem desenvolvidos e aperfeiçoados. Todo o processo de extrusão da empresa é 100% rastreado e supervisionado, desde o corte da matéria-prima (o tarugo), até a embalagem dos perfis já extrudados.



✉ [contato@extrutech.com.br](mailto:contato@extrutech.com.br)

☎ (11) 2600-1638

🏠 Rua João Ranieri, 1290 – Jd. Fátima  
Guarulhos – SP – CEP: 07177-120



**extrutech alumínio**

[www.extrutech.com.br](http://www.extrutech.com.br)